

COBHAM

EXPLORER 710

User manual



Document number: 98-140012-A

Release date: 20 September 2013

Disclaimer

Any responsibility or liability for loss or damage in connection with the use of this product and the accompanying documentation is disclaimed by Thrane & Thrane. The information in this manual is provided for information purposes only, is subject to change without notice and may contain errors or inaccuracies. Manuals issued by Thrane & Thrane are periodically revised and updated. Anyone relying on this information should acquire the most current version e.g. from www.cobham.com/satcom or from the distributor. Thrane & Thrane is not responsible for the content or accuracy of any translations or reproductions, in whole or in part, of this manual from any other source.

Thrane & Thrane A/S trading as Cobham SATCOM.

Copyright

© 2013 Thrane & Thrane A/S. All rights reserved.

Trademark acknowledgements

- **Thrane & Thrane** is a registered trademark of Thrane & Thrane A/S in the European Union and the United States.
- **Inmarsat** is a registered trademark of the International Maritime Satellite Organisation (IMSO) and is licensed by IMSO to Inmarsat Limited and Inmarsat Ventures plc.
- Other product and company names mentioned in this manual may be trademarks or trade names of their respective owners.

Safety summary

The following general safety precautions must be observed during all phases of operation, service and repair of this equipment. Failure to comply with these precautions or with specific warnings elsewhere in this manual violates safety standards of design, manufacture and intended use of the equipment. Cobham SATCOM assumes no liability for the customer's failure to comply with these requirements.

Do not operate in an explosive atmosphere

Do not operate the equipment in the presence of flammable gases or fumes. Operation of any electrical equipment in such an environment constitutes a definite safety hazard.

Keep away from live circuits

Operating personnel must not remove equipment covers. Component replacement and internal adjustment must be made by qualified maintenance personnel. Do not replace components with the power cable connected. Under certain conditions, dangerous voltages may exist even with the power cable removed. To avoid injuries, always disconnect power and discharge circuits before touching them.

Do not service alone

Do not attempt internal service or adjustments unless another person, capable of rendering first aid resuscitation, is present.

Do not substitute parts or modify equipment

Because of the danger of introducing additional hazards, do not substitute parts or perform any unauthorized modification to the equipment.

Keep away from antenna front

This device emits radio frequency energy when switched on. To avoid injury, keep a minimum safety distance of 1 m from the antenna front when the EXPLORER 710 is on.

For information on the safety distance from the transceiver, see the *FCC Radiation Exposure statement* on the next page.



Garder à l'écart de l'avant de l'antenne

Le présent appareil émet des radiofréquences lors de son utilisation. Afin d'éviter tout risque pour la santé, une distance minimale de 1 mètre est nécessaire entre l'utilisateur et l'avant de l'EXPLORER 710.

Pour plus d'informations à propos de la distance de sécurité avec l'appareil, veuillez consulter *Déclaration de l'IC sur l'exposition aux radiations* sur la page suivante.

Only use approved batteries from Cobham SATCOM

Use of non approved batteries may result in explosion, fire, electrical shock or injury.

Observe marked areas

Under extreme heat conditions do not touch areas of the EXPLORER 710 that are marked with this symbol, as it may result in injury.



FCC Radiation Exposure statement

Transceiver Unit (when separated from the Antenna Unit):
This equipment complies with FCC radiation exposure limits for an uncontrolled environment. This equipment should be installed and operated at a distance greater than 20 centimeters (8 inches) between the Transceiver Unit, yourself or any bystander to comply with the Radiation Exposure Requirements.

Déclaration de l'IC sur l'exposition aux radiations

L'émetteur-récepteur (quand séparé de l'antenne) :
Le présent appareil est conforme aux limites de l'IC sur l'exposition aux rayonnements établies pour un environnement non-contrôlé. Le présent appareil doit être installé et utilisé à une distance minimum de 20 centimètres (8 pouces) entre l'émetteur-récepteur et l'utilisateur ou tout autre individu pour être conforme à la réglementation en matière d'exposition radiologique.

Antenna Safety Instructions

Use Only Manufacturer Supplied Antennas
Antenna Minimum Safe Distance: 1 m

Antenna Gain

Directional, with maximum gain of 14.6 dB with reference to isotropic.
The Federal Communications Commission has adopted a safety standard for human exposure to RF (Radio Frequency) energy which is below the OSHA (Occupational Safety and Health Act) limits.

Antenna Mounting

The antenna supplied by the manufacturer must be located such that during radio transmission, no person or persons can come closer than the above indicated minimum safe distance to the front face of the antenna, i.e. 1 m.

L'antenne fournie par le fabricant doit être placée de telle sorte que, durant les transmissions radio, personne ni aucun groupe de personnes ne puisse s'approcher à une distance inférieure à la distance de sécurité minimal indiquée ci-dessus, c.-à-d., 1 m.

To comply with current FCC RF Exposure limits, the antenna must be installed at or exceeding the minimum safe distance shown above, and in accordance with the requirements of the antenna manufacturer or supplier.

Antenna Substitution

Do not use any other antenna than the models supplied or recommended by the manufacturer. You may be exposing people to excess radio frequency radiation. You may contact the manufacturer for further instructions.

Radiation Warning



WARNING! Maintain a separation distance of at least 1 m from the front face of the antenna to a person.

You, as the qualified end-user of this radio device, must control the exposure conditions of bystanders to ensure the minimum separation distance (above) is maintained between the antenna and nearby persons, for satisfying RF Exposure compliance. The operation of this transmitter must satisfy the requirements of Occupational/Controlled Exposure Environment, for work-related use. Only use the terminal when persons are at least the minimum distance from the front face of the antenna.

About this manual

Intended readers

This manual is a user manual for the EXPLORER 710. The manual is intended for anyone who is using or intends to use the EXPLORER 710. No specific skills are required to operate the EXPLORER 710. However, it is important that you observe all safety requirements listed in the **Safety summary** in the beginning of this manual, and operate the EXPLORER 710 according to the guidelines in this manual.

Related documents

The following documents are related to this manual and to the EXPLORER 710 system.

| Title and description | Document number |
|---|-----------------|
| EXPLORER 710 Getting Started, English | 98-139653 |
| EXPLORER 710 Getting Started, Deutsch (German) | 98-140216 |
| EXPLORER 710 Getting Started, Français (French) | 98-140217 |
| EXPLORER 710 Getting Started, Español (Spanish) | 98-140218 |
| EXPLORER 710 Getting Started, Русский (Russian) | 98-140219 |
| EXPLORER 710 Getting Started, 中文 (Chinese) | 98-140220 |
| EXPLORER 710 Getting Started, 日本語 (Japanese) | 98-140221 |

Typography

In this manual, typography is used as indicated below:

Bold is used for the following purposes:

- To emphasize words.
Example: “Do **not** touch the antenna front during pointing”.
- To indicate what the user should select in the user interface.
Example: “Select **Control panel > LAN** and click **Enable**”.

Italic is used to emphasize the paragraph title in cross-references.

Example: “For further information, see *Connecting Cables* on page...”.

Table of Contents

Chapter 1 Introduction to EXPLORER 710

| | |
|--|---|
| General description | 1 |
| Features and interfaces of the EXPLORER 710 | 2 |
| Features | 2 |
| Overview of interfaces | 3 |
| Your EXPLORER 710 terminal | 4 |
| Overview | 4 |
| Display and keypad | 5 |
| User interfaces | 6 |
| Antenna | 6 |
| Compass | 6 |
| Battery | 7 |
| SIM card | 7 |

Chapter 2 Getting Started

| | |
|--|----|
| Unpacking and assembling | 8 |
| Initial inspection | 8 |
| What's in the delivery | 8 |
| To open the transport latch | 9 |
| To detach the antenna | 9 |
| To insert the SIM card | 11 |
| To insert the battery | 11 |
| To remove the battery | 12 |
| To remove the SIM card | 12 |
| Connecting cables | 13 |
| Connectors | 13 |
| To connect the antenna | 14 |
| To connect power | 14 |
| Starting up the EXPLORER 710 | 15 |
| To switch the EXPLORER 710 on or off | 15 |
| Options for the start-up procedure | 15 |
| To enter the SIM PIN | 16 |
| To point the antenna | 16 |
| The registration procedure | 17 |

| | |
|---|----|
| Using a fixed antenna installation | 18 |
| Making the first call or data session | 19 |
| To make the first call | 19 |
| To make the first data connection (LAN) | 20 |
| To make the first data connection (WLAN) | 20 |
| | |
| Chapter 3 Using the EXPLORER 710 | |
| User interfaces | 21 |
| Enabling or disabling an interface | 21 |
| Overview | 21 |
| To enable or disable interfaces with the display and keypad | 21 |
| To enable or disable interfaces with the web interface | 22 |
| Using a Computer, smartphone or tablet | 23 |
| Overview | 23 |
| To choose an interface for data connection | 23 |
| Router function | 23 |
| Standard or Streaming data | 23 |
| To connect to the WLAN interface | 24 |
| To connect to the LAN interface | 25 |
| To start or stop a data connection (LAN or WLAN) | 26 |
| Using a phone | 27 |
| Call types | 27 |
| To connect a phone using LAN or WLAN | 27 |
| To connect an analogue phone | 29 |
| To connect an ISDN phone or modem | 30 |
| To make or receive a phone call with EXPLORER 710 | 31 |
| Local numbers and special functions | 32 |
| To charge your smartphone or tablet | 32 |
| Viewing alarm messages | 33 |
| Adjusting the display | 33 |
| Automatic power up | 33 |
| Restoring factory settings | 33 |
| Viewing properties of the EXPLORER 710 | 34 |
| | |
| Chapter 4 Using the web interface | |
| Introduction | 36 |

| | |
|---|-----------|
| The web interface | 36 |
| To access and navigate the web interface | 36 |
| Entering the SIM PIN in the web interface | 39 |
| Do you need a SIM PIN? | 39 |
| To enter the SIM PIN | 39 |
| Pointing the antenna | 40 |
| Using the Dashboard | 41 |
| To start and stop data connections | 41 |
| To view status | 41 |
| The Control panel | 42 |
| Using the Log | 43 |
| To access the Log | 43 |
| Call log | 43 |
| Data log | 43 |
| Session log | 43 |
| Configuring the LAN interface | 44 |
| To enable or disable the LAN interface | 44 |
| To enable or disable PoE (Power over Ethernet) | 44 |
| Configuring the WLAN interface | 45 |
| To enable or disable the WLAN interface | 45 |
| To configure the WLAN interface | 45 |
| Port forwarding | 46 |
| User group settings (LAN and WLAN) | 47 |
| Configuring the Phone interface | 48 |
| To enable or disable the Phone interface | 48 |
| To configure the Phone interface | 48 |
| Configuring the ISDN interface | 48 |
| To enable or disable the ISDN interface | 48 |
| To configure the ISDN interface | 49 |
| Configuring the USB interface | 49 |
| To enable or disable the USB interface | 49 |
| Managing IP handsets or smartphones | 50 |
| Overview | 50 |
| To manage IP handsets or smartphones in your EXPLORER 710 | 50 |
| Support | 51 |

| | |
|--|-----------|
| To create a diagnostics report | 51 |
| To view the alarm list | 51 |
| To upload software | 52 |
| To view extended status | 52 |
| About | 52 |
| Configuring the terminal settings | 53 |
| To set up pointing at power up | 53 |
| To adjust the display settings | 53 |
| To enable or disable the pointing sound | 53 |
| Viewing the battery status | 53 |
| Advanced settings | 54 |
| Fist time use | 54 |
| To log in | 54 |
| To change the administrator password | 54 |
| To log out as administrator | 54 |
| To restore factory settings | 54 |
| To clear the logs | 55 |
| To clear the total counters | 55 |
| Data limits | 55 |
| To set up the use of SIM PIN in the terminal | 56 |
| To set up user permissions | 56 |

Chapter 5 Maintenance and troubleshooting

| | |
|---|-----------|
| Getting support | 57 |
| Support | 57 |
| Repacking for shipment | 57 |
| Software update | 58 |
| To upload software using the web interface | 58 |
| To upload software with USB | 58 |
| Maintenance | 59 |
| Normal use of the battery | 59 |
| To recharge batteries | 59 |
| To connect an extra external EXPLORER 710 battery | 59 |
| Accurate display of the battery capacity | 60 |
| Storage | 60 |
| Disposal of the EXPLORER 710 | 60 |

| | |
|--|----|
| Troubleshooting | 61 |
| Troubleshooting guide | 61 |
| Status signalling | 66 |
| Log files | 67 |
| Diagnostics report | 67 |
| Call log and data log | 67 |
| | |
| App. A Technical specifications | |
| General specifications | 68 |
| Battery specifications | 69 |
| Interfaces specifications | 70 |
| Power input | 70 |
| Phone/Fax interface | 71 |
| ISDN interface | 72 |
| LAN interface, 2-port | 73 |
| WLAN access point | 74 |
| USB (Host) interface | 74 |
| Antenna interface on transceiver | 75 |
| Detachable antenna | 75 |
| | |
| Glossary | 76 |
| | |
| Index | 79 |

Introduction to EXPLORER 710

General description

The EXPLORER 710 is a handy portable terminal supporting simultaneous voice and data communication over BGAN. It provides versatility and high speed access with multiple interfaces for countless applications. Just connect your phone, laptop, smartphone or tablet, point the antenna towards the BGAN satellite - and you are online.



The EXPLORER 710 provides access to the highest bandwidth available on the BGAN network. With BGAN HDR (High Data Rate) you get a portfolio of four channel streaming rates including symmetric and asymmetric options so you only pay for the data you need. The system offers multi-user as well as single-user functionality, making it a flexible solution for a variety of applications, such as:

- Broadcasting
- Internet browsing
- E-mail
- Phone services
- Large file transfers

- Video conference and Streaming
- VPN (Virtual Private Network) access to corporate servers

The EXPLORER 710 can withstand severe environmental conditions such as humidity, dust, extreme weather and changing temperatures. It is small in size and fits easily into a backpack or similar. With the detachable antenna it is well suited for temporary camps or fixed installations.

Features and interfaces of the EXPLORER 710

Features

- Full duplex, single or multi-user, standard data up to 492 kbps
- Support for streaming data at 32, 64, 128, 176, 256 kbps, HDR (asynchronous or synchronous) and BGAN X-Stream
- Standard LAN w. PoE, WLAN, ISDN and Phone ports and USB Host interface
- Detachable antenna with integrated transceiver stand and transceiver-to-antenna range up to 100 m/328 ft.
- Built-in DHCP/NAT wireless router
- Solar panel direct interface
- Support for battery hot swap
- 10-32 VDC input
- 100-240 VAC power adapter
- Built-in web interface allowing you to manage your calls and customize the terminal to your specific needs, using a smartphone, computer or tablet.
- Point-to-Point Protocol over Ethernet (PPPoE)
- Built-in PBX managing voice communication
- CE, FCC, GMPCS and IC certified

Overview of interfaces

The EXPLORER 710 provides a number of interfaces for connection of various types of computers, phones and other equipment.

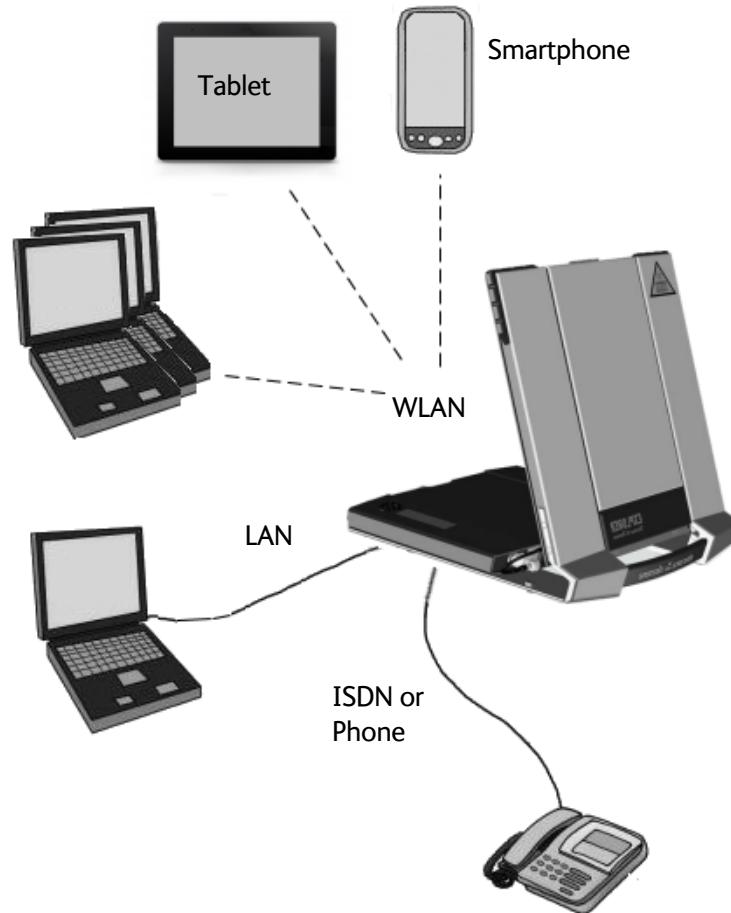

Using the EXPLORER 710 on page 21 describes how to use each of the available interfaces

Minimizing power consumption

The EXPLORER 710 is designed for minimum power consumption. This means that functions that are not currently used will automatically go into a “sleep mode” to minimize the power consumption. In addition to this automatic sleep mode function, you can disable each of the interfaces if they are not currently used. Note, however, that you will not be able to use these interfaces until you enable them again. For information on how to enable/disable interfaces, see *Enabling or disabling an interface* on page 21.

Your EXPLORER 710 terminal

Overview

The EXPLORER 710 is a compact unit comprising a transceiver with a detachable antenna, compass, display and keypad, all in one unit.



Display and keypad

The EXPLORER 710 has a display and keypad providing quick access to important functions and simple setup, and for displaying status.

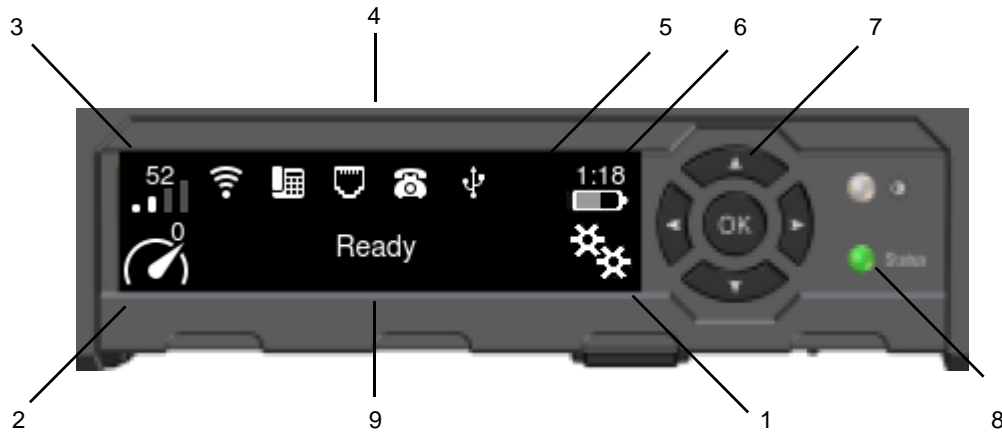

1. **Menu:** Opens the display menu. For a menu overview, see next page.
2. **Connect:** Allows you to start a data connection.
3. **Signal strength:** Shows the signal strength of the satellite connection. Press **OK** to see further status for the satellite connection.
4. **Interfaces on/off:** Allows you to switch the interfaces on or off. Disabled interfaces are crossed out.
5. **Warning:** Shows if there are warning messages. Press **OK** to see the messages.
6. **Battery status:** Shows the status of the internal battery and the external battery (if connected).
7. **Keypad for navigation:** Allows you to move between the available options (arrow keys) and select them (OK).
8. **Status indicator:** Shows status of the EXPLORER 710. For information on functions, see *Status indicator* on page 66.
9. **Status text:** Shows the current status of the EXPLORER 710 and the network connection.

To navigate the display functions

- To **highlight** one of the icons, use the **arrow buttons**.
- To **move around** between the icons, use the **arrow buttons**.
- To **select** menu items, functions or values, press the **OK** key.

Display menu

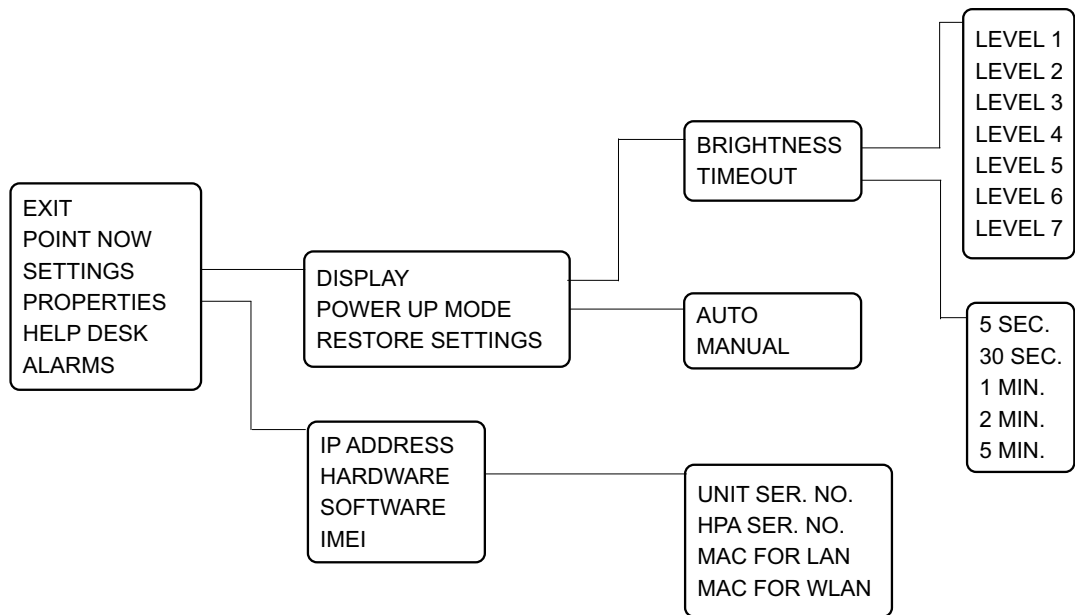

User interfaces

The **keypad and display** are used for pointing the antenna, starting and stopping data sessions, enabling or disabling interfaces and for displaying status and changing simple parameters. To obtain full access to all features and for ease-of-use, you should use a computer or smartphone and the web interface.

The **web interface** is a built-in web interface for easy configuration and daily use. The web interface is accessed from a computer, smartphone or tablet connected to the EXPLORER 710, using an Internet browser. No installation of software is needed.

For further information on the web interface, see *Using the web interface* on page 35.

Antenna

The white part of the EXPLORER 710, including the support bracket, is the detachable antenna module. The antenna module comprises a GNSS (Global Navigation Satellite System) antenna and a BGAN antenna.

A Wireless LAN antenna is located on the transceiver unit.

Compass

The EXPLORER 710 also provides a compass to help positioning the antenna. For further information on how to use the compass, see *To point the antenna* on page 16.

Battery

The EXPLORER 710 comes with a rechargeable battery, which is easily inserted. The battery is automatically recharged when power is applied to the EXPLORER 710. The Status indicator shows that the battery is charging. See *User interfaces* on page 6.

Time between recharging depends on the use. The display shows estimated time left for the battery.

SIM card

The EXPLORER 710 requires a SIM card to go online. Without a SIM card you can still configure the terminal and you may be able to make emergency calls if the network allows it, but you cannot make normal calls nor access the internet.

Getting Started

This chapter describes:

- what is included in the delivery,
- how to insert and remove the battery and SIM card, and
- how to start up the EXPLORER 710 and make the first call or data session.

Unpacking and assembling

Initial inspection

Inspect the shipping carton immediately upon receipt for evidence of damage during transport. If the shipping carton is severely damaged or water stained, request that the carrier's agent be present when opening the carton. Save the carton packing material for future use.



WARNING! To avoid electric shock, do not apply power to the system if there is any sign of shipping damage to any part of the front or rear panel or the outer cover. Read the safety summary at the front of this manual before installing or operating the system.

After unpacking the system, inspect it thoroughly for hidden damage and loose components or fittings. If the contents are incomplete, if there is mechanical damage or defect, or if the system does not work properly, notify your dealer.

What's in the delivery

The following items are included in the delivery:

- EXPLORER 710 terminal including transceiver, antenna and antenna cable
- Battery pack
- AC/DC adapter
- Getting started kit including:
 - Ethernet/ISDN cable, 2 m screened
 - Getting started booklet

To open the transport latch

The EXPLORER 710 has a transport latch, securing the transceiver and antenna during transport.

1. Lift the transport latch to open the terminal.
2. Flip up the antenna module.
You can now access the keypad and connectors on the EXPLORER 710.



To detach the antenna

You have two options for using the EXPLORER 710 antenna:

- **Attached.** You can go through the pointing process with the antenna and transceiver attached as one unit. This means you have to move the entire terminal in order to point the antenna towards the BGAN satellite. If you choose this option, make sure you connect all cables including the short antenna cable, and enter the PIN code, before pointing the antenna. If not, you may accidentally move the antenna when you connect cables or enter the PIN code.
- **Detached.** You can detach the antenna and use it as a separate antenna. With the antenna separated from the transceiver, it is easier to use the transceiver without accidentally moving the antenna. Also, you can choose the optimum location for the antenna while keeping the transceiver in a more comfortable location.

Important

Do **not** place the transceiver in front of the antenna module!
The antenna emits radio frequency energy, which can affect the transceiver.

To detach the antenna, do as follows:

1. Locate the slide locks on the bottom of the terminal.
2. Press and slide the locks outwards while lifting the transceiver to release it from the antenna bracket.



3. Remove the transceiver from the antenna bracket.

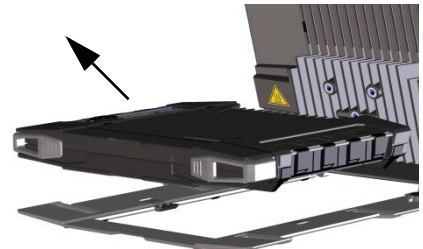

4. To move the antenna and transceiver further apart, disconnect the short antenna cable and connect a longer antenna cable between the antenna and the transceiver.

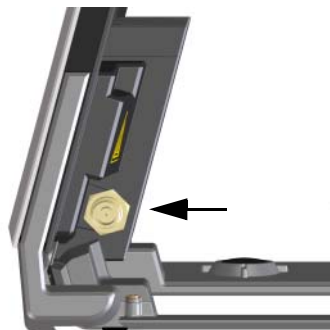
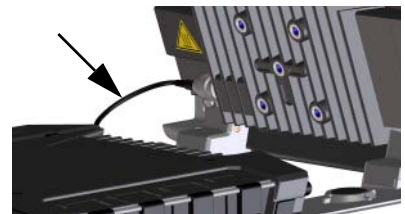

To insert the SIM card

The SIM card is provided by your Airtime Provider. Insert the SIM card as follows:

1. Locate the SIM slot on the same side where the battery is inserted.
2. Insert the SIM card into the SIM slot with the chip side facing up.
3. Press gently until it clicks.
4. Slide the lock in front of the SIM slot.



To insert the battery

Note

The battery should not be partially charged too often. For further information on the battery, see *Maintenance* on page 59.

Do as follows:

1. Insert the battery so that the connector fits into the battery slot, indicated in the figure.
2. Press gently until it locks.

**Note**

Before using the terminal the first time: to ensure accurate information on the battery capacity you should fully charge, then fully discharge the battery, and finally recharge the battery while it is inserted in the terminal. The EXPLORER 710 can be used during the discharging process, but the remaining battery capacity may not be displayed correctly.

To remove the battery

Note For protection of the transceiver, always leave the battery inserted. Only remove the battery to replace it.

To remove the battery, do as follows:

1. If the transceiver and antenna are attached, open the transport latch and detach the antenna as described in *To detach the antenna* on page 9.
2. On the transceiver, open the battery latches as shown.
3. Remove the battery.

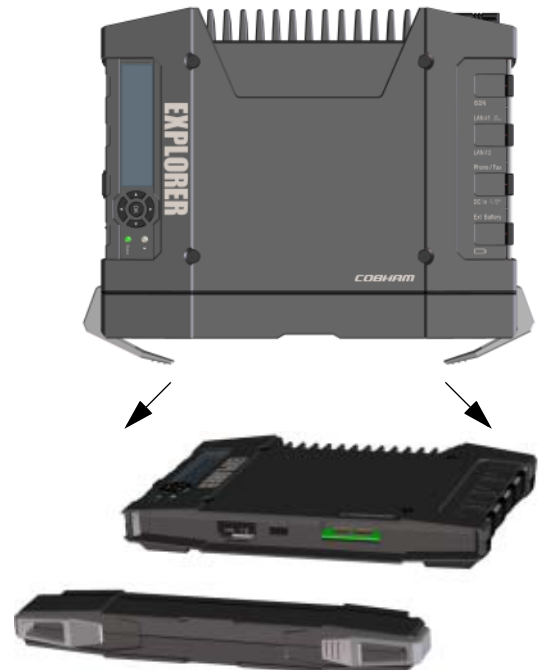

To remove the SIM card

To remove the SIM card, first remove the battery as described in *To remove the battery* on the previous page.

Note When the SIM card is removed you cannot make calls or data sessions, but you can still use the display menu system and the built-in web interface to set up the terminal.

Remove the SIM card as follows:

1. Slide the lock aside to open the SIM slot as shown.
2. Gently press the SIM card and let it pop out of the slot.
3. Remove the SIM card.

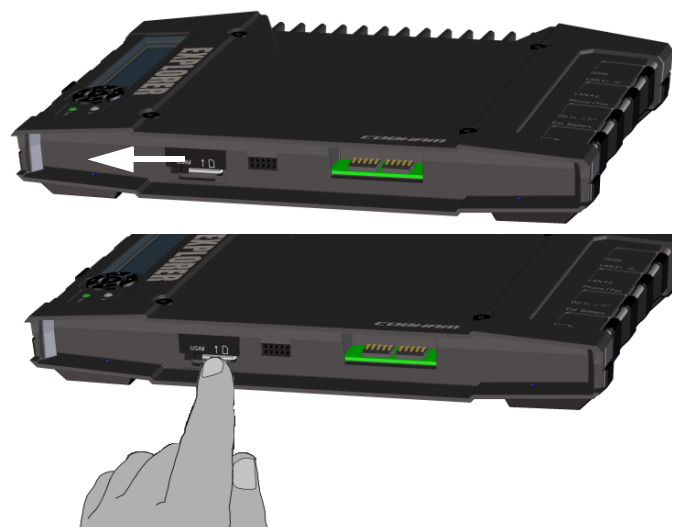

Connecting cables

Connectors

The connector panel is placed on the side of the EXPLORER 710 and has the following connectors:

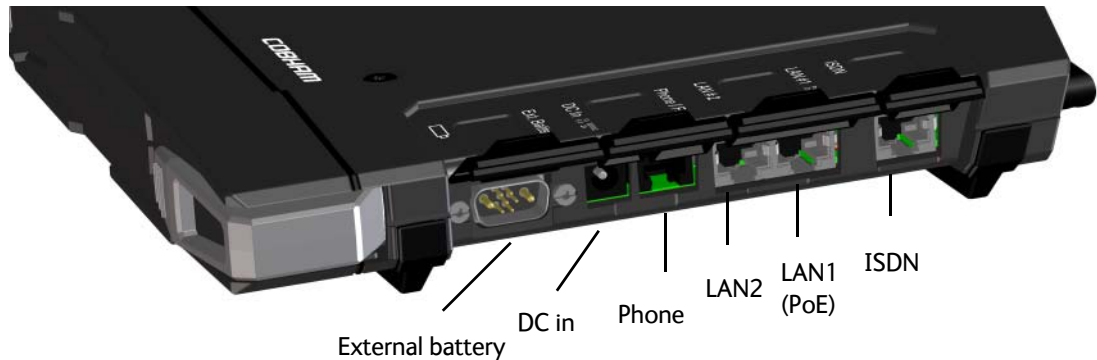

- 1 **Ext battery** connector for connecting an **extra EXPLORER 710 battery**.
See *To connect an extra external EXPLORER 710 battery* on page 59.
- 1 **DC power input** connector for 10 - 32 VDC.
See *To connect power* on page 14.
- 1 **Phone** connector.
See *To connect an analogue phone* on page 29.
- 2 **LAN** connectors, one with **PoE**.
See *To connect to the LAN interface* on page 25 and
To connect a phone using LAN or WLAN on page 27.
- 1 **ISDN** connector.
See *To connect an ISDN phone or modem* on page 30.

Apart from the connectors in the connector panel, there is:

- 1 **USB (Host)** connector placed next to the Power button.
The USB (Host) connector is primarily used for charging phones or tablets (up to 2 A) and for recovery update of software.
See *To charge your smartphone or tablet* on page 32 and
To upload software with USB on page 58.



- 1 **antenna** connector for connecting the antenna module of the EXPLORER 710.
See the next section.

To connect the antenna

The antenna cable is connected at delivery.

Note

If you want to use the antenna separated from the transceiver, use a longer antenna cable and remove the transceiver from the antenna bracket. See the *To detach the antenna* on page 9.

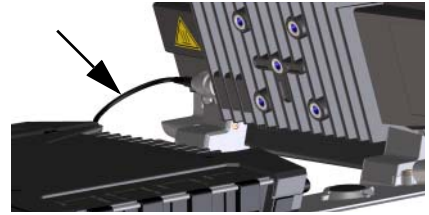

To connect power

When you connect external power to the DC input, the battery is charged while maintaining normal operation.

DC input

Refer to *Technical specifications* on page 68 for specifications and pin-out for the DC Power input.

To power the terminal or to charge the battery, connect one of the following external power sources to the DC input:

- 10-32 VDC
- The supplied AC/DC adapter connected to 100-240 V Mains.
- A solar panel (min. 65 W, 10-32 VDC).

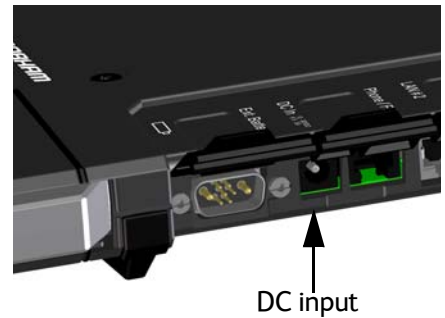

Starting up the EXPLORER 710

To switch the EXPLORER 710 on or off

1. Slide and hold the power button until the Status indicator lights up. This may take some seconds.
2. When the Status indicator flashes slowly or is constant green, and the display shows Ready, the terminal is ready for use.
3. To switch off, hold the power button until the Status indicator flashes yellow. This may take some seconds.



Options for the start-up procedure

Note You can always use the display menu system and the web interface, regardless of SIM card, PIN code and pointing.

When starting up you have different options, e.g. to skip the PIN code and/or the pointing procedure. The following figure shows the options available after power on.

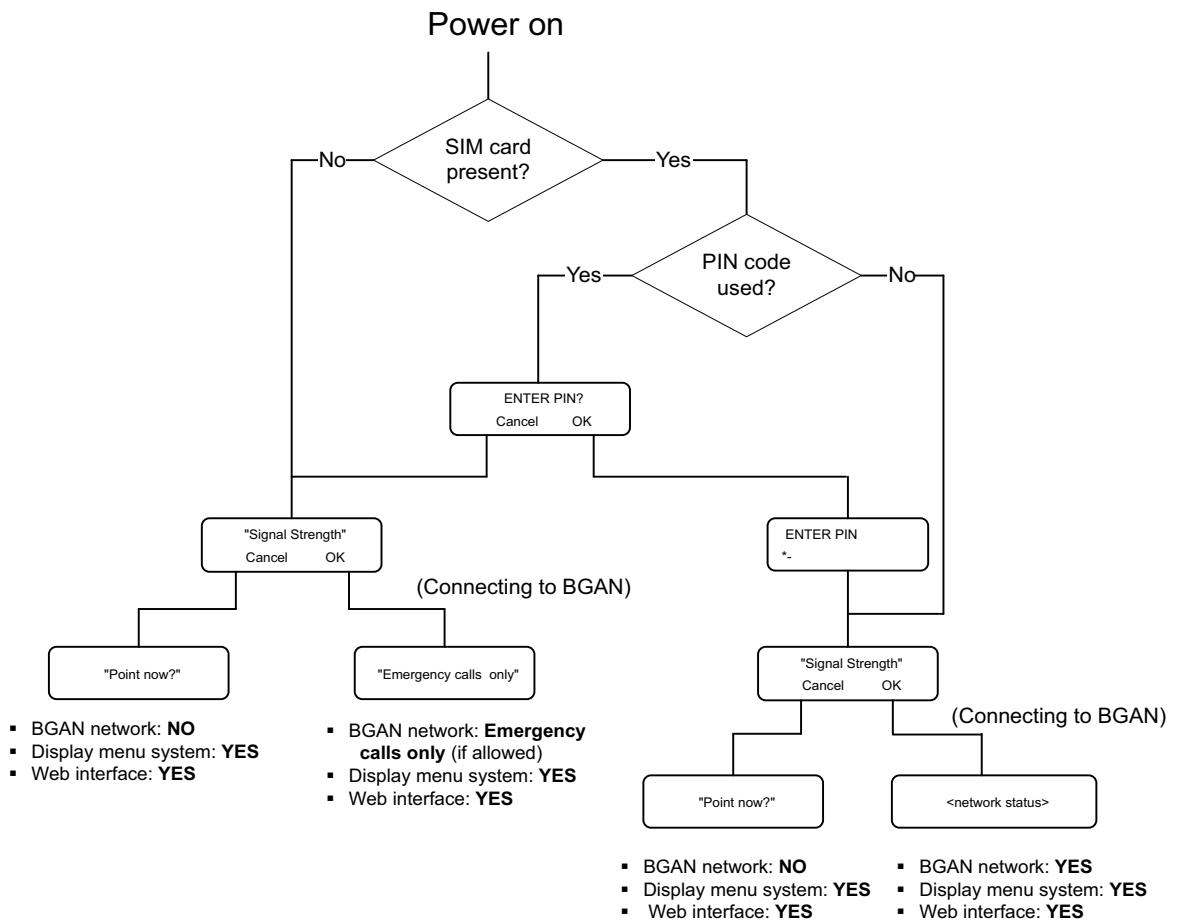

To enter the SIM PIN

To enter the SIM PIN using the display and keypad, do as follows:

1. When the display shows **Enter PIN?**, highlight the text using the arrow keys and press **OK**.
2. Press **▼** or **▲** a number of times until the first digit is correct.
3. Press **OK** to go to the next digit.
The previous digit is indicated by a *.
4. After pressing OK to enter the last digit, press **OK** again to apply the PIN.



For an overview of the display and keypad, see *Display and keypad* on page 5.

To point the antenna

Before pointing

Before pointing the antenna you can use the coverage map below to find your approximate location in relation to the satellites. Then you can use the compass to find the pointing direction to the closest satellite.

The 3 Inmarsat satellites are positioned above the equator, at the centre of each “footprint”.

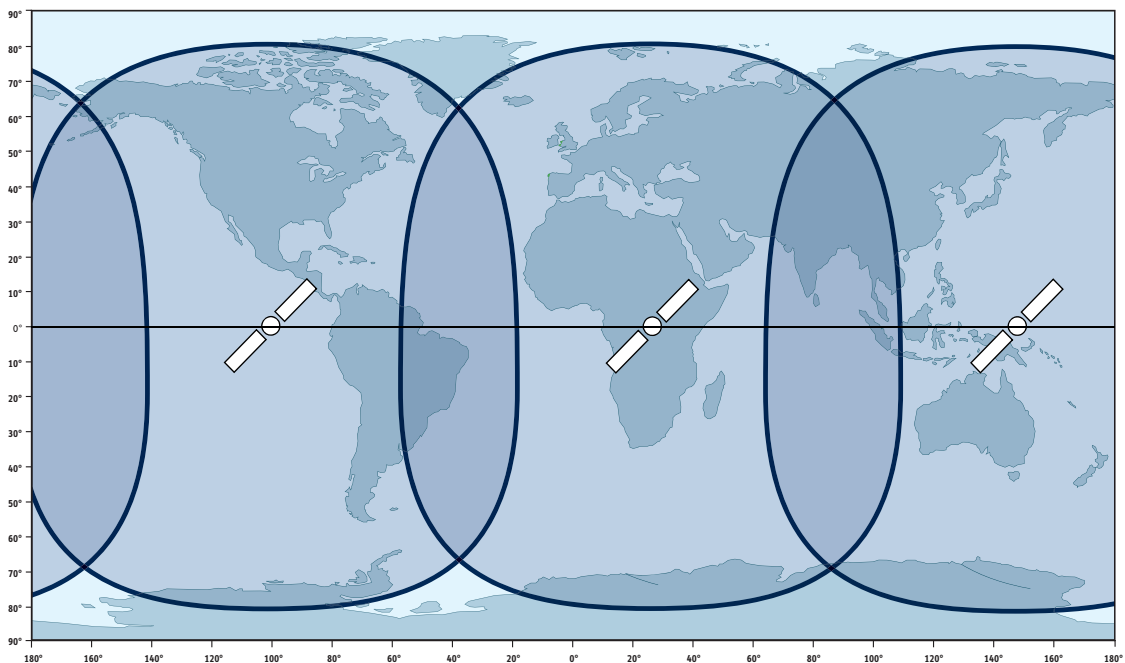

To point the antenna

To obtain optimum bandwidth and operating time, adjust the position of the antenna with great precision.

Do as follows:

1. Use the compass to locate the approximate direction from the antenna front face to the satellite.
2. Slowly rotate and tilt the EXPLORER 710 antenna to find the highest possible signal strength.

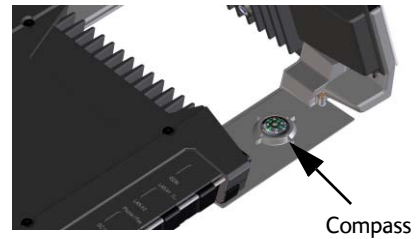

Use the display and the pointing sound to guide you.

Remember that the more accurately the terminal is aligned, the better throughput and lower power consumption you will get!

3. Press **OK** on the display keypad when you have obtained the highest possible signal strength.

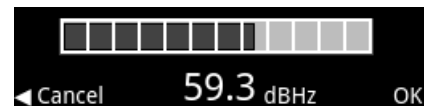

WARNING! After accepting the signal strength, keep the minimum safety distance of **1 m from the antenna front face**. The antenna may radiate microwave power as soon as the signal strength is accepted.

The EXPLORER 710 now starts to establish a connection to the BGAN network.

The registration procedure

The display shows the progress as follows:

- **SEARCHING:**
The EXPLORER 710 searches for the network operator. Note that the search procedure can be very short, so you may not see this text.
- **REGISTERING:**
The EXPLORER 710 is registering itself on the network.
If the GPS position has not yet been acquired at this point, the display may show NO GPS.
- **READY** (or other status information):
READY means the EXPLORER 710 is registered on the network and is ready to go online. If

there is any other status information to show, e.g. if a call or data session is active or there is a warning, the display will show that instead.

Note | By default, the EXPLORER 710 automatically connects to the Internet when you connect equipment to the LAN or WLAN interface (Standard data connection).

If you are not going to use the LAN/WLAN connection, **remove the cable or disable the interface to avoid being charged** for any transmission through this interface.

To repoint the antenna

You may need to point the antenna again later, e.g. if the terminal has been moved or the signal is blocked.

To start the pointing process again, do as follows:

Display: Select  and select **Point now**. Then go through the pointing process as described in the previous section.

web interface: Select  from the top right corner and select **Start**. Then go through the pointing process as described in the previous section, but click **Accept** in the web interface instead of **OK** in the display.

Using a fixed antenna installation

You can keep the EXPLORER 710 antenna in a fixed position, using the Pole mount kit for EXPLORER 710.

Do as follows:

1. Separate the antenna from the transceiver as described in *To detach the antenna* on page 9.
2. Mount the EXPLORER 710 antenna on a pole or a wall, for example using the Pole mount kit.
3. Connect the antenna cable between the antenna and the transceiver.
4. Start up the EXPLORER 710 and point the antenna as described in *To point the antenna* on page 16.
5. Accept the signal strength by pressing **OK** on the EXPLORER 710 keypad.
6. Fasten the EXPLORER 710 antenna in the pointed position.

You only have to point the antenna once, when you mount it. Using a computer connected to the EXPLORER 710, you can set up the EXPLORER 710 to skip pointing at power up. Refer to *To set up pointing at power up* on page 53.

Making the first call or data session

To make the first call

After connecting cables, entering the PIN and pointing the antenna, you are ready to make or receive the first call. The following sections provide a short guide to making calls. For more detailed information, see *To make or receive a phone call with EXPLORER 710* on page 31.

For details on how to connect your phone, see

- *To connect a phone using LAN or WLAN* on page 27
- *To connect an analogue phone* on page 29
- *To connect an ISDN phone or modem* on page 30

To make a call from the EXPLORER 710

To make a call from a phone connected to the EXPLORER 710, dial

00 <country code> <phone number> followed by **#** or off-hook key.

Example: To call Cobham SATCOM in Denmark (+45 39558800) from an analogue phone, dial **00 45 39558800 #**

To make a call to the EXPLORER 710

To make a call to a phone connected to the EXPLORER 710, dial

+ <Mobile number>

- **+** is the prefix used in front of the country code for international calls.
- **Mobile number:** The mobile number of the EXPLORER 710 you are calling. The first part of the mobile number is always 870, which is the “country code” for the BGAN system. For information on your mobile numbers, refer to your airtime subscription.

Note | There are two voice numbers, one for 3.1 kHz Audio and one for Standard Voice.

Example: If you are calling from Denmark and the mobile number for 3.1 kHz Audio is 870782112345 on your EXPLORER 710, and you want to make a call to the EXPLORER 710 using 3.1 kHz Audio, dial **00 870 782112345**.

To make the first data connection (LAN)

Note For the LAN interface to work without any further setup, your computer must be set up to obtain a IP address and DNS server address automatically.

Do as follows:

1. Connect a LAN cable between your computer and LAN#1 or LAN#2 on the EXPLORER 710.
2. When power up and pointing is completed, a Standard data connection is automatically established, if automatic activation is enabled (default enabled).
The status text in the display shows the active connection.

To make the first data connection (WLAN)

To connect to the WLAN interface, do as follows:

1. Check that WLAN is enabled in your EXPLORER 710. The top line of the display shows which interfaces are enabled.
2. If your device is not close to the terminal, turn the WLAN antenna of the transceiver into an upright position.
3. Place your WLAN-enabled device (computer, tablet or smartphone) close to the EXPLORER 710, but **not** in front of the antenna.
4. On your device, search for available WLAN networks.
5. Select the EXPLORER 710 WLAN access point when it appears in your list of available wireless networks. The default name is **EXPLORER710**.
6. You may have to enter a password. By default, the password is the serial number of your EXPLORER 710 and the encoding type is WPA2.



For information on how to configure the WLAN interface, see *Configuring the WLAN interface* on page 45.

Your device should now be connected to the EXPLORER 710. If the EXPLORER 710 is registered on the BGAN network, the connection to the Internet is established automatically.

You are now ready to browse the Internet, check e-mails, send files etc.

Using the EXPLORER 710

User interfaces

The following user interfaces are available when using the EXPLORER 710

- Phone
- ISDN
- LAN
- WLAN
- USB (Host)

Enabling or disabling an interface

Overview

By default, only the LAN interface is enabled. However, you can enable or disable each of the interfaces independently.

To enable or disable interfaces with the display and keypad

To enable or disable an interface, do as follows:

1. In the top of the display, locate the interface you want to enable or disable.





2. Use the arrow keys on the keypad to highlight the interface you want to enable or disable.
3. Press **OK** to toggle between enable and disable. The interface is greyed and crossed out when disabled.



Note It may take some seconds to enable an interface. When the icon is no longer crossed out, the interface is enabled.

To enable or disable interfaces with the web interface

To enable or disable an interface using the web interface, do as follows:

1. Connect your smartphone, tablet or computer to the EXPLORER 710, using the LAN or WLAN interface. See:
 - *To connect to the LAN interface* on page 25 or
 - *To connect to the WLAN interface* on page 24.
2. To access the web interface, open your browser and type **ut.bgan** in the address bar, or type the IP address of your EXPLORER 710.¹ (default IP address: 192.168.0.1)
For further information on the web interface, see *Using the web interface* on page 35
3. When the web interface opens, click  (Control panel) from the bottom right corner of the page.
4. Click the symbol to the right of the interface to enable or disable the interface.
 -  means the interface is **disabled**.
 -  means the interface is **enabled**.

Note

It may take some seconds to enable the interface. When the icon changes to the **enabled** icon, the interface is enabled.

1. You find the IP address in the display menu system by entering the menu and selecting **Properties > IP address**.

Using a Computer, smartphone or tablet

Overview

The following interfaces are available for connecting computers, smartphones or tablets:

- WLAN
- LAN

To choose an interface for data connection

The following table shows some characteristics of each interface to help you choose the right interface for your application.

| Interface | Power consumption | Amount of setup | Range |
|-----------|-------------------|---|--|
| WLAN | High | Some setup necessary on your WLAN device and in the web interface of the EXPLORER 710 | Wireless connection. Up to 100 m depending on the transmitter in the computer and on the transmission conditions. |
| LAN | High | None (or very little) | Up to 100 m of cable |

Router function

The terminal has a router function which routes traffic between the local network connected to the terminal and the BGAN network connection (also called PDP context on the BGAN network).

The router contains NAT (Network Address Translation) which allows sharing of a public IP address between a number of local network users.

Standard or Streaming data

Definition

The BGAN network supports different classes of data connection to the Internet. The main classes are **Standard data** and **Streaming data**.

- Using a **Standard data** connection, several users can share the data connection simultaneously. This type of connection is ideal for TCP/IP traffic such as e-mail, file transfer, and Internet and intranet access.
The user pays for the amount of data sent and received.
- Using a **Streaming data** connection, you get an exclusive, high-priority connection, ensuring seamless transfer of data. This type of connection is ideal for time critical applications like live video over IP.
The user pays for the duration of the connection (per minute charge).

To connect to the WLAN interface

To connect to the WLAN interface, do as follows:

1. Check that WLAN is enabled in your EXPLORER 710. The top line of the display shows which interfaces are enabled.
2. If your device is not close to the EXPLORER 710, turn the WLAN antenna of the transceiver into an upright position.
3. Place your WLAN-enabled device (computer, tablet or smartphone) close to the EXPLORER 710, but **not** in front of the antenna.
4. On your device, search for available WLAN networks.
5. Select the EXPLORER 710 WLAN access point when it appears in your list of available wireless networks. The default name is **EXPLORER710**.
6. You may have to enter a password.
By default, the password is the **serial number** of your EXPLORER 710 and the encoding type is **WPA2**.



For information on how to configure the WLAN interface, see *Configuring the WLAN interface* on page 45.

Your device should now be connected to the EXPLORER 710. If the EXPLORER 710 is registered on the BGAN network, and automatic activation is enabled in the terminal, the connection to the Internet is established automatically. The status text in the display shows if there is an active data connection.

You are now ready to browse the Internet, check e-mails, send files etc.

Calls: If you want to use WLAN to make calls over the BGAN network, you must have a SIP client installed on your smartphone. See *To connect a phone using LAN or WLAN* on page 27.

To connect to the LAN interface

Before connecting to the LAN interface

The LAN interface on the EXPLORER 710 comprises two connectors. If more than one LAN or WLAN user is connected to the EXPLORER 710, the terminal should be in Router mode. Refer to *Configuring the LAN interface* on page 44 and *User group settings (LAN and WLAN)* on page 47.

To connect to the LAN (Local Area Network) interface, use a shielded cable mounted with an RJ-45 connector.

For specifications, refer to *LAN interface, 2-port* on page 73.

For the LAN interface to work without any further setup, the computer must be set up to obtain an IP address and a DNS server address automatically.

To connect to the LAN interface

This section does not describe configuration of the LAN interface. For information on configuration, see *Configuring the LAN interface* on page 44.

To connect to the LAN interface, do as follows:

1. Connect the LAN cable to the network interface of your computer. A suitable cable is provided with your EXPLORER 710.
2. Connect the other end of the cable to one of the LAN connectors on the EXPLORER 710.

Important The ISDN interface and the LAN interface use the same connector type. Be careful not to connect to the wrong interface.



If the EXPLORER 710 is registered on the BGAN network, and automatic activation is enabled in the terminal, the connection to the Internet is established automatically. The status text in the display shows if there is an active data connection.

To start or stop a data connection (LAN or WLAN)

By default, if the terminal is powered, pointed and registered on the BGAN network, a Standard data connection is automatically established when LAN or WLAN equipment is connected.

However, you can disable automatic activation in the web interface. See *User group settings (LAN and WLAN)* on page 47.

To start or stop a data connection manually using the display and keypad, do as follows:

1. Connect your equipment to the interface you want to use.
2. Start up the terminal as described in *Starting up the EXPLORER 710* on page 15.
3. Use the arrow keys to highlight the connection icon in the bottom left corner of the display.



4. Press **OK** to see the available connections.
5. Select the connection type you want to start or stop.
6. Press **OK** on the keypad.

Note

It may take some time to start up the connection. The display shows the status while the connection is being established and when it has been started.

For information on how to start and stop data connections with the web interface, see *To start and stop data connections* on page 41.

Using a phone

Call types

Definition

The phone connection can be either a **Standard Voice** connection or a **3.1 kHz Audio** connection. In the web interface you can set up which type of connection to use by default when you make or receive a call from the Phone, ISDN or LAN/WLAN interface (IP handset).

When making calls **to** the terminal, the mobile number determines which call type is used. In your airtime subscription you have one number for 3.1 kHz Audio and one number for Standard Voice.

When connecting a modem you must use 3.1 kHz Audio.

Example: If you always have a modem connected to the Phone interface you can set this interface to 3.1 kHz Audio only. This means that if an incoming Standard Voice call is received, the Phone interface will not ring.

For information on how to set up the call types in the web interface, see *Configuring the Phone interface* on page 48

To connect a phone using LAN or WLAN

Your smartphone or IP phone can be set up to make and receive calls over the BGAN network, using the terminal's phone number. You can also make local calls to other handsets connected to the EXPLORER 710.

Note

Make sure your phone has an integrated SIP client. If you do not have a SIP client, you can find SIP applications available for download on the Internet.

First time SIP setup

If it is the first time you connect your phone to the LAN or WLAN interface for making calls, you must first set up the SIP server details in your smartphone. For information how, see the user documentation for your smartphone and for the SIP application. You may be asked to enter some of the following details:

- SIP server address and port: Default address: 192.168.0.1, Port: 5060
- User name: Local no. in EXPLORER 710 (0501 to 0515)
- Password: Default same as user name
- Codec priority: Highest priority codec type: G.711

Note

The user name and password must match the IP handset settings in the web interface of the EXPLORER 710. See *Managing IP handsets or smartphones* on page 50.

To connect your smartphone for making calls

For details on **initial setup** of your smartphone and the EXPLORER 710, see

- The documentation for your handset
- *First time SIP setup* on page 27.
- *Managing IP handsets or smartphones* on page 50.

To use your phone to make calls through the EXPLORER 710 using WLAN, do as follows:

1. Start up the EXPLORER 710 terminal.
2. Connect your smartphone to the wireless access point of the EXPLORER 710.
See *To connect to the WLAN interface* on page 24.
3. Start your SIP application.

You should now be ready to make and receive calls over BGAN.



To connect a wired IP handset for making calls

Note | Make sure your IP handset complies with PoE class 2 (7 W).

For details on **initial setup** of your IP handset and the EXPLORER 710, see

- The documentation for your handset
- *First time SIP setup* on page 27.
- *Managing IP handsets or smartphones* on page 50.

To connect a wired IP handset, do as follows:

1. Start up the EXPLORER 710 terminal.

Note | Make sure PoE is enabled in the terminal. See *Configuring the LAN interface* on page 44.

2. Connect the LAN cable between the IP handset and the connector LAN #1 on the EXPLORER 710.

When the IP handset is powered and ready, you should now be able to make and receive calls over BGAN.

To connect an analogue phone

Before connecting to the Phone interface

To connect a phone to the Phone/Fax connector, you need an analog telephone cable with an RJ-11 connector. For specifications and pin-out, refer to *Phone/Fax interface* on page 71.

To connect to the Phone/Fax interface

Do as follows:

1. Connect the cable to your phone.
2. Connect the other end of the cable to the Phone/Fax connector on the EXPLORER 710.

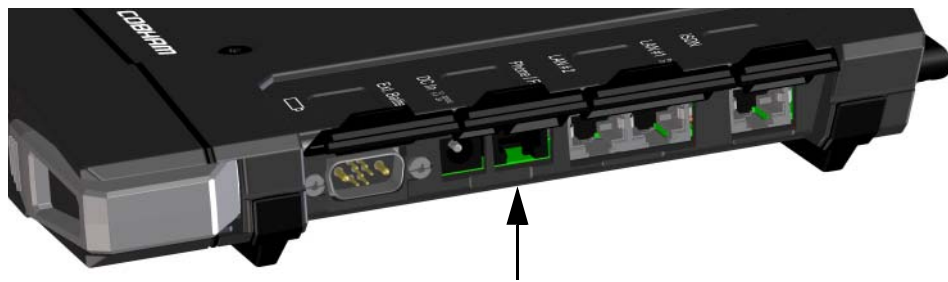

3. Power up the EXPLORER 710 and point the antenna as described in *To point the antenna* on page 16.
4. Check the connection by making a phone call.
See *To make or receive a phone call with EXPLORER 710* on page 31.

If connection fails, check that the interface is enabled in the EXPLORER 710.

If the analogue phone icon is crossed out in the display main screen, the interface is disabled. See *Enabling or disabling an interface* on page 21.

To connect an ISDN phone or modem

Before connecting to the ISDN interface

To connect a phone or modem to the ISDN connector, you need an ISDN cable with an ISDN connector. For specifications and pin-out, refer to *ISDN interface* on page 72.

To connect to the ISDN interface

The ISDN interface supports connection of up to 8 devices per ISDN interface. However, if you are going to connect more than one device, the devices must be self-powered. The ISDN interface can supply maximum 1 W.

The BGAN Core network presently only supports one 64 kbps ISDN channel per subscription.

Do as follows:

1. Connect the ISDN cable to your phone or modem.
2. Connect the other end of the cable to the ISDN connector on the EXPLORER 710.



3. Power up the EXPLORER 710 and point the antenna as described in *To point the antenna* on page 16.
4. Check the connection by making a phone call.
See *To make or receive a phone call with EXPLORER 710* on page 31.

If connection fails, check that the ISDN interface is enabled in the EXPLORER 710.

If the ISDN icon is crossed out in the display main screen, the interface is disabled. See *Enabling or disabling an interface* on page 21.

To make or receive a phone call with EXPLORER 710

Smartphone, analogue phone, ISDN phone or IP handset

First connect your phone to the relevant interface. For further information, see:

- Smartphone: *To connect your smartphone for making calls* on page 28
- Analogue phone: *To connect an analogue phone* on page 29
- ISDN phone: *To connect an ISDN phone or modem* on page 30
- IP handset: *To connect a wired IP handset for making calls* on page 28

To make a call from the EXPLORER 710

- To make a call, dial **00 <country code> <phone number>** followed by **#** or off-hook key.

Example: To call Cobham SATCOM in Denmark (+45 39558800), dial **00 45 39558800 #**

If there was an error establishing the connection, the web interface and the display of the EXPLORER 710 show an error message.

To receive a call

By default, all devices connected to the EXPLORER 710 will ring when one of the mobile numbers is called. Note however, that this depends on the call type settings. See *Call types* on page 27

Information on missed calls is stored in the call log. You can see the call log in the web interface (Control panel  > Log > Call log).

To make a call to the EXPLORER 710

To make a call to a phone connected to the EXPLORER 710, dial **+ <Mobile number>**

- **+** is the prefix used in front of the country code for international calls. This is **00** when calling from countries in Europe and from many other countries.
- **Mobile number.** The first part of the mobile number is always 870, which is the “country code” for the BGAN system. For information on the mobile numbers, refer to your airtime subscription.

Note | There are two mobile numbers, one for **3.1 kHz Audio** and one for **Standard Voice**.

Local numbers and special functions

Overview

There are a number of local numbers and dialing functions available in the EXPLORER 710.

The following list shows the allocated local numbers and special-purpose numbers for the EXPLORER 710.

| Number | Function |
|--|--|
| 0 * followed by # or off-hook key | Redial last called number on this interface. |
| 00 * followed by # or off-hook key | Redial last answered call on this interface. Note: If the last answered number is an unlisted number, you will not be allowed to dial back. |
| 00 followed by one of the numbers 1-199 and # or off-hook key | Short dial phone numbers in phone book. |
| 0300 followed by # or off-hook key | Local call to analog phone. |
| 0400 followed by # or off-hook key | Local call broadcast to all ISDN phones. |
| 0 followed by one of the numbers 401-408 and # or off-hook key | Local call to one ISDN phone. |
| 0900 followed by # or off-hook key | Local call broadcast to all handsets. |

Apart from the numbers above, the EXPLORER 710 uses the following dialing prefixes:

- **1*** before the phone number will force the connection to use **Standard Voice**.
- **2*** before the phone number will force the connection to use **3.1 kHz Audio**.
- **#31#** before the phone number will hide the callers phone number to the recipient.
- ***31#** before the phone number will show the callers phone number to the recipient where it would otherwise be hidden, e.g. because the number is an ex-directory number.

To make local phone calls

You can make local calls between phones connected to the EXPLORER 710. For an overview of the available numbers, see the table in the previous section.

To make a local call, dial **<local number>** followed by **#** or off-hook key.

To charge your smartphone or tablet

To charge your smartphone or tablet, connect it to the USB interface next to the power button on the EXPLORER 710. The connector is a standard USB A connector.



Viewing alarm messages

When an alarm is present, the display and the web interface shows an alarm icon.

To see a list of active alarms in the display, do as follows:

1. From the display menu, select **ALARMS**.
2. Select an alarm to see details for the alarm.

Adjusting the display

To adjust the display brightness and timeout, do as follows:

1. From the display menu, select **SETTINGS > DISPLAY**.
2. Select **BRIGHTNESS** and select the wanted level with **OK**.
3. Select **SETTINGS > DISPLAY > TIMEOUT**.
4. Select the period of time the display light should stay on after the last key is pressed.

Automatic power up

The default behaviour of the EXPLORER 710 is to power up automatically when you connect the power cable. If you wish, you can change this power up mode, so that the EXPLORER 710 is only powered if the Power button is pressed.

To switch between automatic and manual power up of the terminal, do as follows:

1. From the display menu, select **SETTINGS > POWER UP MODE**.
2. Select **Auto** or **Manual**.
 - Auto: The EXPLORER 710 powers up automatically when external power is applied.
 - Manual: The EXPLORER 710 powers up only when the power button is pressed.

Restoring factory settings

Important

All custom settings will be lost and the EXPLORER 710 configuration is restored to how it left the factory.

To restore the factory settings of the EXPLORER 710, do as follows:

1. From the display menu, select **SETTINGS > RESTORE SETTINGS**.
2. Press **OK**.

Viewing properties of the EXPLORER 710

Using the display and keypad, you can see properties of the EXPLORER 710. Do as follows:

1. From the display menu, select **PROPERTIES**.
2. To see the local IP address of the EXPLORER 710, Select **IP ADDRESS**.
3. To see serial numbers and MAC addresses for the EXPLORER 710, select **HARDWARE**.
4. To see the software version of the EXPLORER 710, select **SOFTWARE**.
5. To see the IMEI number of the EXPLORER 710, select **IMEI**.

Using the web interface

This chapter describes how to use the web interface to operate, set up and configure your system. It has the following sections:

- *Introduction*
- *Entering the SIM PIN in the web interface*
- *Pointing the antenna*
- *Using the Dashboard*
- *The Control panel*
- *Using the Log*
- *Configuring the LAN interface*
- *Configuring the WLAN interface*
- *Port forwarding*
- *User group settings (LAN and WLAN)*
- *Configuring the Phone interface*
- *Configuring the ISDN interface*
- *Configuring the USB interface*
- *Managing IP handsets or smartphones*
- *Support*
- *Configuring the terminal settings*
- *Viewing the battery status*
- *Advanced settings*

Introduction

The web interface

What is the web interface?

The web interface is built into the terminal and is used for operating, setting up and configuring the system.

You can access the web interface from a computer, tablet or smartphone with a standard Internet browser.

To access and navigate the web interface

To access the web interface

To access the web interface, do as follows:

1. Start up the terminal.
For details, see *Starting up the EXPLORER 710* on page 15.
2. Connect your computer to the terminal.
3. Open your browser and enter **ut.bgan** in the address bar.
If your connected computer is set up to obtain a DNS server address automatically, this name is translated into the local IP address of the terminal. If not, you can enter the IP address of the terminal instead. The default IP address of the terminal is **192.168.0.1**.

Note

Some parts of the web interface may not be accessible if the user permissions are limited. For information on how to set up user permissions, see *To set up user permissions* on page 56.

Overview of the web interface

When the web interface opens, the title bar shows the name of the product.

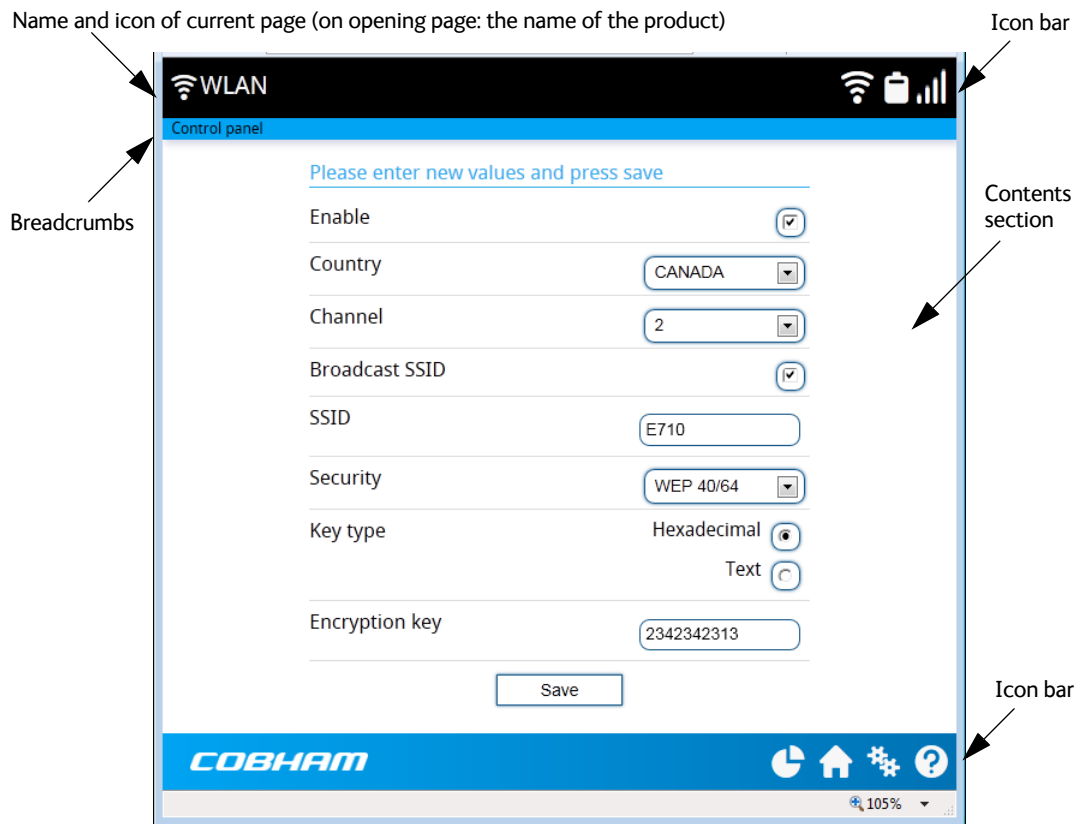











The web interface consists of the following sections.

- **Name** of current page. Tap or click to refresh the page.
- **Icon bars** at the top and bottom are present on all pages and holds icons that give access to status such as battery level and signal level as well as active events, when relevant. It also holds the main menu. For explanations of the icons, see the next section, *Icons in the icon bars*.
- **Breadcrumbs** right below the icon bar show the current location in the menu system and gives access to the higher levels in the menu.
- **Contents section** shows the contents of the selected page. This section is used for viewing or changing settings, or for performing actions. On the opening page, this section is used to start and stop data connections.

Icons in the icon bars

The icon bars are always available at the top and bottom of the web interface. Some of the icons are permanent while others are temporary.

| Icon | Explanation |
|--|--|
|  | Power status. The icon changes according to status. Tap or click to see detailed battery status. |
|  | Battery level |
|  | Battery charging |
|  | No battery. Running on external power. |
|  | Signal level. Tap or click to see general status information. |
|  | WLAN interface. Bright when WLAN is enabled, greyed when it is disabled. Tap or click to access WLAN settings. |
|  | Help. Tap or click to get context-sensitive help for the current page. |
|  | Control panel. Tap or click to access the settings. |
|  | Home. Tap or click to return to the startup page (Dashboard). |
|  | If the screen is not large enough to show the status field, this icon appears at the bottom of the page. Hover over the icon to see status of the terminal and satellite connection. |
|  | An alarm is active. Click the icon to see a list of active alarms. Note that this icon will remain in the icon bar as long as the alarm is still active. |

To navigate the web interface

- **To access status and settings**, tap or click the relevant icon in the icon bar or select  to access the **Control panel**. The status or settings are displayed in the contents section.
- **To see your current location and to move back through the Control Panel menu**, use the breadcrumbs just below the icon bar.
- **To scroll through longer pages**, use the scroll bar or swipe.
- **To refresh the current page**, click the page's icon in the top left corner.

Entering the SIM PIN in the web interface

Do you need a SIM PIN?

Note

You may not have to enter a SIM PIN to access the terminal. This depends on whether or not the use of a SIM PIN is enabled on your SIM card.

The administrator can enable and disable the use of a SIM PIN. For details, see *To set up the use of SIM PIN in the terminal* on page 56

If a smartphone, tablet or computer is connected when you start up the terminal, you can access the web interface and enter the SIM PIN here.

To enter the SIM PIN

If your SIM card requires a PIN and the PIN has not yet been entered, you must enter it before you can make calls or access the Internet. Until you have entered the PIN you cannot access the satellite network, but you can still configure your terminal.

To enter the PIN, do as follows:

1. Access the web interface.
If the terminal needs a PIN, a popup window tells you to enter PIN.
2. Type in your PIN code and click **OK**.

When the correct PIN is entered, the terminal is ready for pointing. When pointing is completed and the terminal is registered on the network, you are ready to make calls or access the Internet.

To cancel the SIM PIN

If you select **Cancel** when you are asked for a PIN, you can use the web interface as normal, but you will not be able to access the BGAN network to make calls or data sessions. Only emergency calls will be possible, and only if the network allows it.

To enter the PIN later, after cancelling the first time, do as follows:

1. From the icon bar at the top, click .
The alarm list opens.
2. Click **Resolve** next to **Please enter PIN code**.
3. Type in your PIN code and click **OK**.

Pointing the antenna

For detailed information on the pointing procedure, see *To point the antenna* on page 16.

You can use the web interface to help you with the pointing process. To start the pointing procedure, do as follows:

1. If the pointing process is not automatically started, select  and select **Start**.
The signal strength is shown on the screen.
2. Turn and tilt the antenna until you have obtained the highest possible signal strength.
3. Click **Accept**.

The terminal will now try to register on the BGAN network.

Using the Dashboard

The Dashboard has two main functions: To start and stop data connections and to view status. For other functions available from the icon bars at the top and the bottom, see *Icons in the icon bars* on page 38.

To start and stop data connections

To start and stop data connections on your EXPLORER 710, do as follows:

1. In the middle of the Dashboard, locate the connection profile you want to start.
2. Click  to start the connection.



Note | Once a Streaming connection is started, the connection will run until you stop it. You will be charged for the time you are connected.

3. Click  to stop the connection.

By default, the following connections are available:

| Name | Type of connection |
|---|---|
| Standard data | Several users can share the data connection simultaneously. This type of connection is ideal for TCP/IP traffic such as e-mail, file transfer, and Internet and intranet access. The user pays for the amount of data sent and received. |
| Streaming data The following Streaming classes are available: 32, 64, 128, 176 or 256 Streaming BGAN X-Stream Full HDR symmetric Half HDR symmetric Full HDR asymmetric (64 kbps download, Full HDR upload) Half HDR asymmetric (64 kbps download, Half HDR upload) | An exclusive, high-priority connection, ensuring seamless transfer of data. This type of connection is ideal for time critical applications like live video over IP. The user pays for the duration of the connection (per minute charge). |

To view status

If the window is large enough, it shows a status field at the bottom of the page. If not, hover over  to show the status page. When you move away from the  icon, you return to the previous page.

The Control panel

The control panel is used for accessing the settings and functions of your EXPLORER 710.

To open the control panel, click  from the bottom right corner of the web interface.

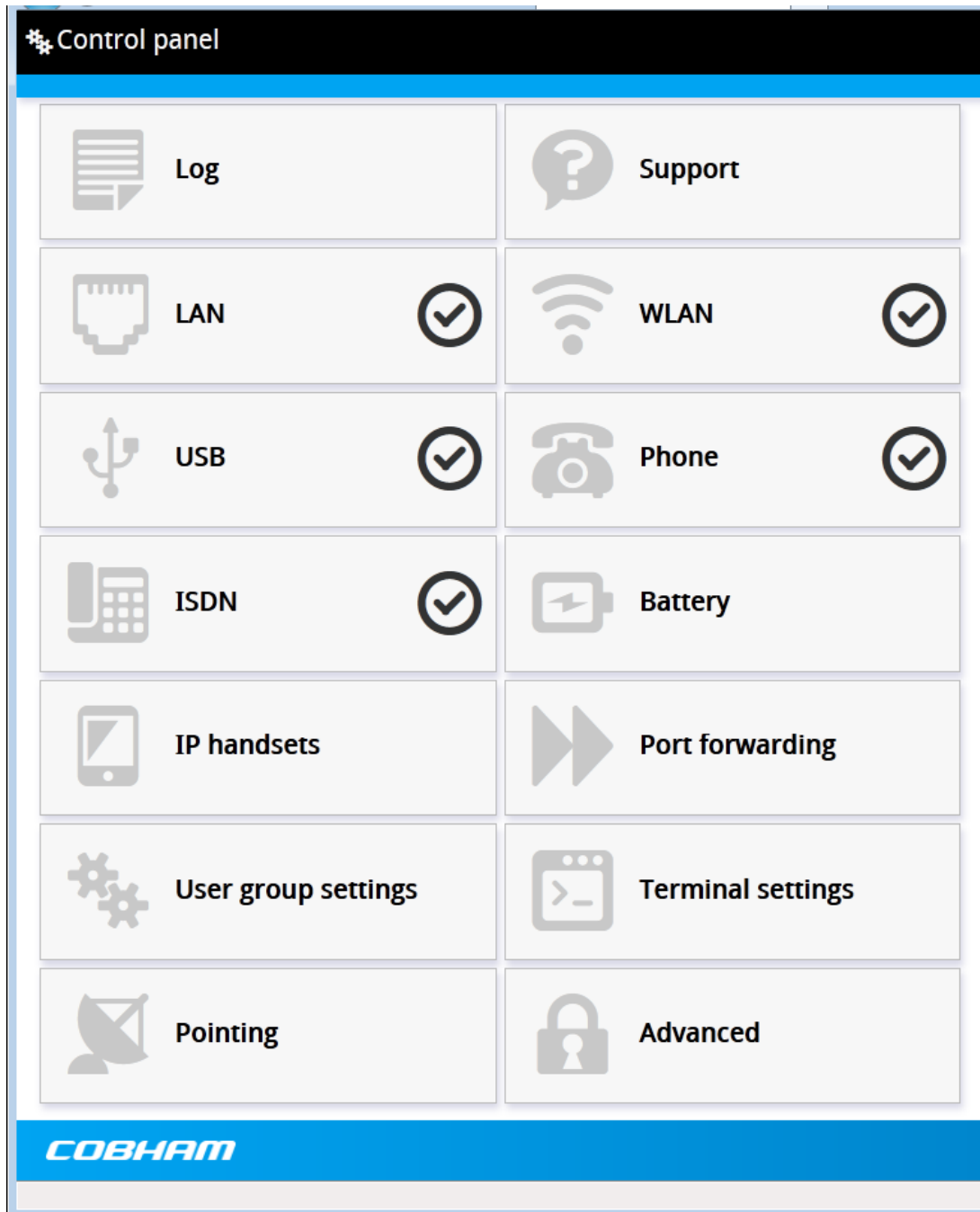

Using the Log

To access the Log

To access the Log, select  and select **Log** from the menu. The Log page contains:

- **Call log:** A list of all incoming, outgoing and missed calls since the log was last cleared.
- **Data log:** A list of all data sessions since the log was last cleared.
- **Session log:** Totals for each type of service since the log was last cleared.

Date and time is the international UTC time, received from the satellite.

Call log



The Call log shows:

- **Outgoing calls** shows the start time, receiving end phone number, duration and type (Standard voice or 3.1 kHz audio).
- **Received calls** shows the start time, calling phone number, duration and type (Standard voice or 3.1 kHz audio) of each incoming call.
- **Missed calls** shows the start time, calling phone number and type (Standard voice or 3.1 kHz audio) of each incoming call that was not received.

You can clear the Call log under **Control Panel**  > **Advanced** > **Clear logs** (requires Administrator password).

Data log

The Data log shows:

- **Standard data** shows bytes uploaded , bytes downloaded , date and time of each Standard data session.
- **Streaming data** shows the duration and type (such as 64 kbps, 256 kbps), date and time for each Streaming session.

You can clear the Data log under **Control Panel**  > **Advanced** > **Clear logs** (requires Administrator password).

Session log

The Session log shows:

- **Call session totals** shows the total duration (hh:mm:ss) for each call type since the log was last cleared.
- **Data session totals** shows totals for each data connection type since the log was last cleared. For Standard data the totals are shown as amount of data transferred (kB) and for Streaming connections the totals are shown in duration (hh:mm:ss).



You can clear the Session log under **Control Panel**  > **Advanced** > **Clear total counters** (requires Administrator password).

Configuring the LAN interface

The terminal has two LAN connectors. LAN#1 is with PoE (Power over Ethernet).

To enable or disable the LAN interface

To enable or disable the LAN interface, do as follows:

1. In the Control panel, locate the LAN field.
2. Click the symbol in the right side to enable or disable the LAN interface.
 -  means the interface is **disabled**.
 -  means the interface is **enabled**.

Note It may take some seconds to enable the interface. When the icon changes to the **enabled** icon, the interface is enabled.

To enable or disable PoE (Power over Ethernet)

To enable or disable PoE for LAN#1, do as follows:

1. From the Control panel , select **LAN**.
2. To enable **Power over Ethernet** (PoE) on LAN#1, select **Enable**.
PoE is used e.g. for powering IP handsets. If you are not using PoE, you can save power by disabling PoE.



For a description of how to set up the **LAN network parameters**, see *User group settings (LAN and WLAN)* on page 47.

Configuring the WLAN interface

Note | The LAN network settings entered in the User group settings page also apply for the WLAN interface.

To enable or disable the WLAN interface

To enable or disable the WLAN interface, do as follows:

1. In the Control panel, locate the WLAN field.
2. Click the symbol in the right side to enable or disable the WLAN interface.
 -  means the interface is **disabled**.
 -  means the interface is **enabled**.

Note | It may take some seconds to enable the interface. When the icon changes to the **enabled** icon, the interface is enabled.

To configure the WLAN interface

To configure the WLAN interface, do as follows:

1. From the Control panel , select **WLAN**.
2. Next to **Country**, select the country you are located in.

Note | In some countries, the use of WLAN is not allowed. Before continuing, make sure WLAN is allowed and licensed in the country where you intend to use it.

3. Select the **Channel** number used for communication on the WLAN interface.
4. Next to **Broadcast SSID**, select **Enabled** to show your WLAN access point to other users.
If you **clear** the Enabled box, your WLAN access point is hidden.
5. Type in the **SSID**.
The SSID is a max. 32 character text identifying the wireless local area network. All wireless devices on a WLAN must use the same SSID in order to communicate with each other. The default SSID is **EXPLORER710**.
6. Select the **Security** standard. You may select one of the following encryption standards:
 - None (no encryption is applied)
 - WEP-40/64
 - WEP-104/128
 - WPA-TKIP
 - WPA2-AES (selected by default)

7. Next to **Key type**, select **Hexadecimal** or **Text**.
The encryption key must normally be a hexadecimal code. However, if you are using WPA or WPA2 encryption (default) you can choose to use a text string, which may be easier to memorize.
8. Type in the **Encryption key** for the selected Security standard (not applicable if security mode = None).
The default encryption key is the **serial number** of the EXPLORER 710.
9. Click **Save**.

Port forwarding

Port forwarding enables you to set up a server connected to the terminal while the terminal is in Router mode. Without port forwarding it would not be possible to contact the server from the Internet.

We recommend using a static public IP address for the terminal in order to provide easy access to the terminal.

The following example shows how to allow Internet access to a mail server (smtp) connected to the terminal.

The mail server in this example has the IP address 192.168.0.100.

1. From the **Control panel** , select **Port forwarding**.
2. Select **Forward port** to add a new port forwarding.
3. Select **Active** to activate the port forwarding.
4. Type in the **Incoming port start** and the **Incoming port end**.
This is the range of port numbers on the EXPLORER 710 for which incoming traffic to the EXPLORER 710 will be forwarded.
5. Type in the **Destination IP** address, which in this example is the IP address of the mail server: 192.168.0.100.
This is the IP address to which the incoming traffic is forwarded.
6. Type in the **Destination port start** and the **Destination port end**.
This is the range of port numbers, in this example on the mail server, to which the incoming traffic will be forwarded.
7. Click **Save**.

You can now access the mail server from the Internet, using the public IP address of the terminal.

User group settings (LAN and WLAN)

To set up your LAN or WLAN network settings, do as follows:

1. From the **Control panel** , select **User group settings**.
2. Under **Internet connection mode**, select **Modem mode** or **Router mode**. Router mode is recommended for most purposes.
 - Select **Router mode** if one or more computers are connected using the LAN interface, and the EXPLORER 710 should act as a router. When Router mode is selected, the EXPLORER 710 uses the built-in NAT module for making the necessary address translations.
 - Select **Modem mode** if only one computer is connected to the LAN interface, and the EXPLORER 710 should act as a modem, or more than one computer is connected to the LAN interface using an external router.

Note | Do **not** connect more than one computer to the LAN interface in Modem mode, unless you have an external Router.



3. To enable automatic activation of your data connection, select **Enable** next to **Automatic activation**.
 - When you **enable** automatic activation and connect to the LAN or WLAN interface, the data connection is automatically established as soon as the EXPLORER 710 and its BGAN connection are ready.

Note | You are charged for the data transferred. You may want to disable automatic updates in your LAN or WLAN device to avoid unnecessary charges.

- When you **disable** automatic activation, you can control the data connection manually from the dashboard.
4. To enable IP Header compression, select **Enable** next to **IP Header compression**. IP Header compression means the bandwidth is used more efficiently, whereas no compression means the data packets take up more bandwidth but are transmitted more reliably with less data loss.
 5. Next to **APN**, select the source of the APN.
 - **SIM default** (recommended): The APN is taken from the SIM card.
 - **Network assigned**: The APN is assigned from the network.
 - **User defined**: APNs are provided from the Airtime Provider. Type in the APN next to **User defined name**.
 6. If your APN uses a password, type in the **User name** and **Password** provided from the Airtime Provider.
 7. Click **Save**.

Configuring the Phone interface

To enable or disable the Phone interface

1. In the **Control panel** , locate the **Phone** field.
2. Click the symbol in the right side to enable or disable the Phone interface.
 -  means the interface is **disabled**.
 -  means the interface is **enabled**.

Note



It may take some seconds to enable the interface. When the icon changes to the **enabled** icon, the interface is enabled.

To configure the Phone interface

1. In the **Control panel** , select **Phone**.
2. Set the call type for incoming calls.
You can select **Standard voice** or **3.1 kHz audio** or both.
 - If you select both, any device connected to the Phone interface will react (ring) on incoming calls.
 - If you select e.g. Standard voice, the Phone interface will only react on calls made to the Standard voice phone number.
3. Set the **Preferred outgoing call type**.
You can select either **Standard voice** or **3.1 kHz audio**. The selected type will be used by default, if possible, for any outgoing call.
4. Click **Save**.

Configuring the ISDN interface

To enable or disable the ISDN interface

1. In the **Control panel** , locate the **ISDN** field.
2. Click the symbol in the right side to enable or disable the ISDN interface.
 -  means the interface is **disabled**.
 -  means the interface is **enabled**.

Note



It may take some seconds to enable the interface. When the icon changes to the **enabled** icon, the interface is enabled.

To configure the ISDN interface

1. In the **Control panel** , select **ISDN**.
2. Set the call type for incoming calls.
You can select **Standard voice**, **3.1 kHz audio**, **UDI** and/or **RDI**.
An incoming call to the ISDN interface will only make the connected device ring if the call type used for the call is selected here.
3. Set the **Preferred outgoing call type**.
You can select either **Standard voice**, **3.1 kHz audio**, **UDI** or **RDI**. The selected type will be used by default, if possible, for any outgoing call.
4. Click **Save**.

Configuring the USB interface

To enable or disable the USB interface

1. In the **Control panel** , locate the **USB** field.
2. Click the symbol in the right side to enable or disable the USB interface.
 -  means the interface is **disabled**.
 -  means the interface is **enabled**.

Note It may take some seconds to enable the interface. When the icon changes to the **enabled** icon, the interface is enabled.

Note that the USB interface is a Host interface, primarily used for charging devices such as tablets or smartphones and for recovery software upload.

To select the charge current

To select the charge current for charging smartphones or tablets from the USB interface, do as follows:

1. From the **Control panel** , select **USB**.
2. Select the **Charge current**.
Select **0.5 A** or **2.0 A**, depending on the specifications for the device you are going to connect.
3. Click **Save**.

Managing IP handsets or smartphones

Overview

This section describes how to manage smartphones and IP handsets connected to the EXPLORER 710.

The terminal supports connection of up to 15 handsets. Each handset must have a local number in the range 0501 to 0515 as well as a unique password. For details, see the next section.



For details on SIP settings and how to connect your handset to the LAN or WLAN interface, see *To connect a phone using LAN or WLAN* on page 27.

To manage IP handsets or smartphones in your EXPLORER 710

Do as follows:

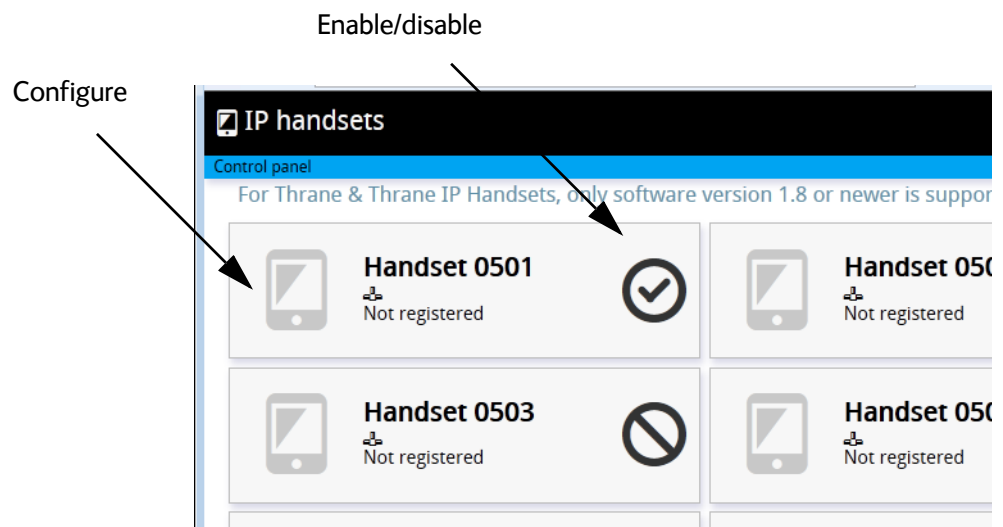
1. Connect your smartphone to the WLAN interface or your IP handset to the LAN#1 port of the terminal.
for details, see *To connect a phone using LAN or WLAN* on page 27.
2. In the web interface, select  (Control panel) > **IP handsets**.



3. Locate the handset number you want to manage.
4. Click the symbol in the right side to enable or disable the handset.
 -  means the handset is **disabled**.
 -  means the handset is **enabled**.
5. Click in the left side to access the settings of the handset.
6. To change the **Password**, simply type in the new number.

7. Set the call type for incoming calls.
You can select **Standard voice** or **3.1 kHz audio** or both.
 - If you select both, the handset will react (ring) on incoming calls.
 - If you select e.g. Standard voice, the handset will only react on calls made to the Standard voice phone number.
8. Set the **Preferred outgoing call type**.
You can select either **Standard voice** or **3.1 kHz audio**. The selected type will be used by default, if possible, for any outgoing call from this handset.
9. Click **Save**.
10. In the smartphone or IP handset, enter the local number and the password you just entered in the web interface. See the documentation for your handset for details.

Note | The user name is also the local number for the handset.

The handset remains in the list after disconnecting. When the handset is connected again, it is automatically recognized and ready for use, if enabled.

Support

To open the Support page, select  (Control panel) > **Support**.

To create a diagnostics report

The diagnostic report contains relevant information for troubleshooting. When contacting your distributor for support, please enclose this file. To generate a diagnostic report, do as follows:

1. From the **Support** page, click **Diagnostics report**.
2. Select **Generate report**.

Note | It may take a few minutes to generate the report.

3. Select **Download report**.
4. Choose a location for the file and save it.

To view the alarm list

When an event is registered, the web interface shows an alarm icon  in the icon bar as long as the event is active. The **Alarm list** only shows events that are currently active, whereas the **Event log** shows the history of events that have occurred.

To view the alarm list, click  from the icon bar at the top of the web interface, or select **Alarm list** from the **Support** page.

To upload software

To upload software from your computer to the terminal, do as follows:

1. Download the new software or acquire the software from Cobham SATCOM and save it on your computer.
2. Open the web interface and enter the Control panel .
3. Click **Support > Upload software**.
4. Click **Upload software update**.
5. Browse to the new software version and click **Open**.

Note | The upload procedure takes a couple of minutes.

When the new software file is uploaded, a button with the name of the software file pops up.

6. Click the button with the filename of the new software.
7. The EXPLORER 710 software is now updated.

If, for some reason, you cannot upload software using the web interface, you can also use the USB interface. For details, see *To upload software with USB* on page 58.

To view extended status

To see the Extended status page, select **Support > Extended status**.

To view updated information on the **Extended status page**, click the icon in the top left corner to refresh the page.

The Extended Status page shows information such as IAI-2 status, IMSI number and IMEI number.

About

The **About** page shows the **software version** of your EXPLORER 710 and legal information. To access the page, select **Support > About**.

Configuring the terminal settings

To set up pointing at power up

To set up pointing at power up, do as follows:

1. From the **Control panel** , select **Terminal settings**.
2. If the EXPLORER 710 is moved around between each power up, select **Pointing required at power up**. With this setting, the terminal will go through the pointing procedure every time the terminal is powered.
3. If the EXPLORER 710 antenna is placed in a fixed position and the signal strength is sufficient, **clear** the check box next to **Pointing required at power up** to make the EXPLORER 710 automatically establish a connection when the terminal is powered.
4. Click **Save**.

To adjust the display settings

To adjust the built-in display of the EXPLORER 710, do as follows:

1. In the **Terminal settings** page, locate the **Terminal display** section.
2. Next to **Brightness** select the wanted level from the dropdown list.
3. Next to **Timeout**, select the period of time from last key press until the display light is turned off.
4. Click **Save**.

To enable or disable the pointing sound

The EXPLORER 710 can make a sound to guide you through the pointing procedure. To enable or disable the pointing sound, do as follows:

1. In the **Terminal settings** page, locate the **Audio indicators** section.
2. Check or clear the check box next to **Pointing**.
3. Click **Save**.

Viewing the battery status

To view the status of the internal and external (if any) battery, do one of the following:

- Click the battery symbol from the icon bar at the top of the page, or
- from the Control panel , select **Battery**.

Advanced settings

Fist time use

The first time you access the EXPLORER 710 you are logged in as administrator by default. You are then guided to enable use of admin password and to type in the administrator password you want to use.

To log in

The advanced settings normally require an administration password. To log in as administrator, do as follows:

1. From the Control panel , select **Advanced**.
If you are not logged in as administrator you are now prompted to log in.
2. Enter the Administration password.
3. Click **Login**.
You now have access to the advanced settings of your EXPLORER 710.

To change the administrator password

To change the administrator password, do as follows:

1. Log on as administrator
2. Under **Advanced**, click **Change admin password**.
3. Type in the **Old password**.
4. Type in the **New password** and retype it on the next line.
5. Click **Save**.
At the next logon the new password is required.

To log out as administrator

To log out manually, click **Logout admin** in the **Advanced** page.

To restore factory settings

To restore the factory settings of the EXPLORER 710, do as follows:

1. Under **Advanced**, click **Restore factory defaults**.



All configuration will be lost and the EXPLORER 710 will return to the default configuration.

2. Click **OK**.

The terminal will now reboot and start up with the factory settings

To clear the logs

To clear the logs of the terminal, do as follows:

1. Under **Advanced**, click **Clear logs**.
2. Click **OK**.
This will clear the call log and the data log.

To clear the total counters

To reset the counters for the time connected, do as follows:

1. Under **Advanced**, click **Clear total counters**.
2. Click **OK**.
This will reset the **Time connected** counters in the session log.

Data limits

You can set a limit for the use of data services with the EXPLORER 710 system.

Once the entered limit is reached, the connection is automatically stopped. This is recorded in the data log. To continue using the data service you must start a new connection by clicking on the desired connection on the Dashboard.

Note | If you set a data limit for the Standard data connection, automatic activation of the Standard data connections is disabled.

To set data limits, do as follows:

1. From the **Advanced** page, select **Data limits**.
2. Select the type of connection you want to limit.
3. Type in the number of kilobytes (kB) or the time (number of minutes) allowed.
4. Select **Enabled**.
5. Click **Save** to save the settings.

To set up the use of SIM PIN in the terminal

To enable or disable the use of a SIM PIN

To enable or disable the use of a PIN to access the terminal, do as follows:

1. From the **Advanced** page, select **Change SIM PIN**.
2. Under **Enable/Disable PIN** select or clear the box next to **Require PIN on startup**.
 - If you clear the box, you can access and use the terminal without entering a PIN.
 - If you select the box, you must enter a PIN on startup before you can make calls or data sessions.
3. If you selected Require PIN on startup, type in the PIN next to **Current PIN**.
4. Click **Save**.
The new PIN settings will take effect at next power on.

To change the SIM PIN

To change the PIN used to access the terminal, do as follows:

1. From the **Advanced page**, select **Change SIM PIN**.
2. Under **Change SIM PIN** type in the **Current PIN**.
3. Type in the **New PIN** and retype it on the next line.
4. Click **Save**.
The new PIN settings will take effect at next power on.

To set up user permissions

You can allow or deny users who are not administrators access to certain functions and make these pages read-only. This is useful if you want to protect the system against unintended changes. Study this screen thoroughly and decide to which areas of the system you want to give non-administrator users access. To set up the user permissions, do as follows:

1. From the **Control panel** , click **Advanced**.
1. Click **User permissions**.
2. Under **Allow users to:**, select the settings you want to **allow** users to access. Settings user.
3. Click **Save**.
The settings without a check mark can only be viewed but not changed by the non-administrator user.

Maintenance and troubleshooting

Getting support

Support

Should your Cobham SATCOM product fail, please contact your dealer or installer, or the nearest Cobham SATCOM partner. You will find the partner details on www.cobham.com/satcom where you also find the Cobham SATCOM Self Service Center web-portal, which may help you solve the problem.

Your dealer, installer or Cobham SATCOM partner will assist you whether the need is user training, technical support, arranging on-site repair or sending the product for repair.

Your dealer, installer or Cobham SATCOM partner will also take care of any warranty issue.

Repacking for shipment

Should you need to send the product for repair, please read the below information before packing the product.

The shipping carton has been carefully designed to protect the EXPLORER 710 and its accessories during shipment. This carton and its associated packing material should be used when repacking for shipment. Attach a tag indicating the type of service required, return address, part number and full serial number. Mark the carton FRAGILE to ensure careful handling.

Note | Correct shipment is the customer's own responsibility.

If the original shipping carton is not available, the following general instructions should be used for repacking with commercially available material.

1. Wrap the defective unit in heavy paper or plastic. Attach a tag indicating the type of service required, return address, part number and full serial number.
2. Use a strong shipping container, e.g. a double walled carton.
3. Protect the front- and rear panel with cardboard and insert a layer of shock-absorbing material between all surfaces of the equipment and the sides of the container.
4. Seal the shipping container securely.
5. Mark the shipping container FRAGILE to ensure careful handling.

Failure to do so may invalidate the warranty.

Software update

To upload software using the web interface

For information on how to update software using the web interface, see *To upload software* on page 52.

To upload software with USB

If the web interface is not available, you may also use the USB interface to upload the software from a USB memory stick.

You need: A FAT formatted USB Flash drive (memory stick) with a capacity of at least 100MB.

Do as follows:

1. Download the EXPLORER 710 software image from the Cobham SATCOM support server to your computer.
2. Insert the USB memory stick into your computer and copy the EXPLORER 710 software image file to the drive.
3. Rename the file name to "tt3720b.tiff".
4. Remove the USB memory stick from the computer (also known as "safely remove hardware").
5. On the EXPLORER 710, check in the display that the USB interface is enabled.
6. Insert the USB memory stick into the EXPLORER 710 USB connector on the front.
7. The EXPLORER 710 will read the software image from the USB memory stick and after a short moment start the software update process.
8. To indicate the software update process is ongoing, the EXPLORER 710 status LED will be flashing blue.
9. Wait for the status LED to display green to indicate the software update process is completed.
10. Remove the USB memory stick.
11. Power-cycle the EXPLORER 710.

Maintenance

Normal use of the battery

It is recommended not to partially charge/discharge the battery several times in a row. Partial charging/discharging affects the accuracy of the capacity measurement.

Never leave the battery fully discharged for a longer period of time. If the battery is not to be used for a shorter period of time (1 month), charge the battery to minimum 20 to 30% and remove it from the EXPLORER 710. If the Battery is stored for more than a month, see *Storage* at the end of this section.

To recharge batteries

One battery inserted

To recharge the battery, connect external power to the DC input of the EXPLORER 710 while the battery is inserted. For details on how to apply external power, see *DC input* on page 14.

Two batteries connected

You may connect an extra, external EXPLORER 710 battery for extra capacity. When external power is applied to the EXPLORER 710, both batteries are charged as follows:

One battery is charged to 80%. Then the other battery is charged to 80%, and then they are both charged the last bit up to 100%. This is because the last 20% take longer to charge, and this way the batteries are charged in the shortest possible time.

The display and the web interface of the EXPLORER 710 show battery status such as which battery is currently charging and the battery level.

To connect an extra external EXPLORER 710 battery

If you are not close to a power source, you may want to use an extra EXPLORER 710 battery as backup. Do as follows:

1. Acquire an extra EXPLORER 710 battery with a dedicated cable for hot-swap from Cobham SATCOM.
2. Connect the dedicated cable between the EXPLORER 710 battery and the External battery connector on the EXPLORER 710.
The EXPLORER 710 continues normal operation on the inserted battery until it runs out of power.
3. When the inserted battery runs out of power, the EXPLORER 710 switches to the external battery and continues normal operation.

Important

Before removing the empty battery, click/select the battery symbol in the web interface or the display to check that the EXPLORER 710 is actually running on the external battery.

4. If you have a third charged battery ready, you can now take out the inserted battery and replace it with the new one, without interrupting the operation of the EXPLORER 710.

Accurate display of the battery capacity

To ensure accurate display of the battery capacity, it is recommended to run a “learning cycle” for every 100 recharge/discharge and at first time use. The learning cycle must be performed at 20°C-30°C.

A learning cycle is performed as follows:

1. Fully charge the battery.
2. Remove external power and fully discharge the battery:
Use the EXPLORER 710 and/or leave it on until it turns off automatically. This way the EXPLORER 710 “learns” the complete capacity of the battery. Note that it may take several hours to discharge the battery if it is not in use.
3. Recharge the battery.

Storage

Do not leave the battery inserted in the EXPLORER 710 during storage. If the battery is not to be used for a longer period of time, do as follows:

1. Fully charge the battery.
2. Remove external power. Then use the EXPLORER 710 or leave it on until the display shows a battery capacity of approximately 50%.
3. Switch off the EXPLORER 710.

Important

Switch off the EXPLORER 710 before removing the battery!

4. Remove the battery and store it.

In this condition the battery can be stored for approximately 1 year at 20°C to 30°C. After 1 year you must recharge the battery. For further information on storage temperature, see *Battery specifications* on page 69.

Disposal of the EXPLORER 710

Old electrical and electronic equipment marked with this symbol can contain substances hazardous to human beings and the environment. Never dispose these items together with unsorted municipal waste (household waste).



In order to protect the environment and ensure the correct recycling of old equipment as well as the re-utilization of individual components, use either public collection or private collection by the local distributor of old electrical and electronic equipment marked with this symbol.

Contact the local distributor for information about what type of return system to use.

Troubleshooting

Troubleshooting guide

| Problem | Possible cause | Remedy |
|---|--|---|
| The EXPLORER 710 cannot be switched on, or does not stay on when powered by the battery. | The battery needs recharging. | Recharge the battery. Check the battery indicator in the display. |
| | The battery is not inserted properly. | Remove the battery and re-insert it. Make sure the battery is inserted properly and that the latches are locked. |
| | The battery contacts are dirty or damaged. | Clean the battery contacts if necessary. If the contacts are damaged, replace the battery. |
| There is no light in the power indicator nor in the display when the EXPLORER 710 is switched on. | The EXPLORER 710 may be in Stealth Mode (all lights and sounds are off). | Press ◀ and ▶ simultaneously on the display keypad. This will toggle Stealth Mode on/off. |
| The display cannot be read, it is dimmed or dark. | The brightness setting is too low. | In the web interface set Brightness to a higher level. (Control panel > Terminal settings > Terminal display) |
| The EXPLORER 710 cannot be switched off. | The Power button was not held long enough. | When you switch off the EXPLORER 710, hold the power button until the light indicator flashes rapidly yellow. In rare cases, it may take up to 10 seconds to switch off the EXPLORER 710. |
| Charging error | The temperature is below 0°C or above 40°C. | Only charge the battery when the temperature is within the range 0°C to 40°C. |
| | The charging voltage is lower than the specified minimum voltage. | Wait until charging begins (the Status indicator flashes yellow). If the battery is completely discharged, and it has been out of use for a long time, the charging process may take a long time to start. If charging does not begin within 2-3 hours, contact your local distributor, or purchase a new battery. |

| Problem | Possible cause | Remedy |
|--|---|---|
| The display shows Insert SIM. | The SIM card is not present. | Remove the battery and insert the SIM card in the SIM slot according to the instructions in the section <i>To insert the SIM card</i> on page 11. |
| | The SIM card is not inserted properly. | Remove the SIM card and re-insert it according to the instructions in the section <i>To insert the SIM card</i> on page 11. |
| The display shows No GPS fix. | The EXPLORER 710 is unable to register on the network, because the GPS position is unknown. | Make sure the view to the GPS satellites is not blocked. To obtain GPS fix, the EXPLORER 710 should be placed flat on an even surface pointing straight upwards, with a clear view to as much of the sky as possible. When the EXPLORER 710 has obtained GPS fix, you can point the antenna towards the BGAN satellite. To see the GPS status, select  in the display. |
| The display shows Emergency calls only. | The BGAN network is only available for emergency calls. The reason may be one of the following: 1) Your Airtime subscription has expired. 2) You are using the wrong SIM card. 3) No SIM card is inserted. 4) You have cancelled the PIN code | 1) Check your subscription with the Airtime Provider. 2) Check that your SIM card is valid for communication on the BGAN network. 3) Insert the SIM card 4) Enter the PIN code |
| The display shows Not registered. | The EXPLORER 710 cannot register on the BGAN network. | Check that your SIM card is valid for communication on the BGAN network. Check your subscription with the Airtime Provider. |

| Problem | Possible cause | Remedy |
|--|---|--|
| The EXPLORER 710 cannot obtain its position using GPS. | There is no GPS signal, or the signal is weak. If the EXPLORER 710 has not been used recently within the same location, it can take up to 10 minutes to obtain the GPS position. | Check the GPS status in the display or the web interface. To help the EXPLORER 710 obtain GPS fix, it should be placed flat on an even surface pointing straight upwards, with a clear view to as much of the sky as possible. When the EXPLORER 710 has obtained GPS fix, you can point the antenna towards the BGAN satellite. |
| No signal or weak signal from the BGAN satellite. | The view to the satellite is blocked. | Make sure the EXPLORER 710 has a clear view to the satellite. Be aware that window glass may reduce the signal level. |
| | The antenna is pointed in the wrong direction. | Check that the antenna is pointed according to the position data. Adjust the position to the highest possible signal strength. |
| Connection to the Internet cannot be established. | The signal strength is too low. | Check that the antenna is pointed according to the position data. Adjust the position to the highest signal strength you can obtain. As a rule of thumb, you should have a signal strength of 45 dBHz or more to be able to make a call or data session. |
| The web interface cannot be accessed. | The browser is configured to use a proxy server. | For Microsoft Internet Explorer, select Tools > Internet Options > Connections > LAN Settings and uncheck Use a proxy server for your LAN . |
| | You have entered a wrong IP address. | Check the IP address and re-enter it. The default IP address is 192.168.0.1 |

| Problem | Possible cause | Remedy |
|---|---|---|
| A Phone connection cannot be established. | The interface is disabled in the EXPLORER 710. | Enable the interface by selecting the Phone interface icon in the display, or by accessing the web interface and selecting Control panel , and clicking the icon in the right side of the Phone field. |
| | The cable is not properly connected. | Connect the cable. |
| | The cable type or connector type is not correct. | For information on the correct type of connector, refer to <i>Phone/Fax interface</i> on page 71. |
| | Incoming calls: The call type used for the call is not selected in the web interface. | Make sure the call type used for calls to the EXPLORER 710 is selected in the web interface. Access the web interface and select Control panel > Phone . Then select the call type for incoming calls. |
| An ISDN connection cannot be established | The ISDN interface is disabled in the EXPLORER 710 | Enable the interface by selecting the ISDN interface icon in the display, or by accessing the web interface and selecting Control panel , and clicking the icon in the right side of the ISDN field. |
| | The cable is not properly connected. | Connect the cable. |
| | You have connected to the LAN interface. | Connect the cable to the interface marked ISDN. |
| | The cable type or connector type is not correct. | For information on the correct type of connector and cable, refer to <i>ISDN interface</i> on page 72. |
| | Incoming phone calls: The call type used for the call is not selected in the web interface. | Make sure the call type used for calls to the EXPLORER 710 is selected in the web interface. Access the web interface and select Control panel > ISDN . Then select the call type for incoming calls. |

| Problem | Possible cause | Remedy |
|---|--|---|
| A LAN connection cannot be established. | The interface is off in the EXPLORER 710. | Enable the interface by selecting the LAN interface icon in the display, or by accessing the web interface and selecting Control panel , and clicking the icon in the right side of the LAN field. |
| | The cable is not properly connected. | Connect the cable. |
| | The cable type or connector type is not correct. | For information on the correct type of connector and cable, refer to <i>LAN interface, 2-port</i> on page 73. |
| | You have connected to the ISDN interface. | Connect the cable to the interface marked LAN#1 or LAN#2. |
| A WLAN connection cannot be established | The WLAN interface is disabled in the EXPLORER 710 | Enable the interface by selecting the WLAN interface icon in the display, or by accessing the web interface and selecting Control panel , and clicking the icon in the right side of the WLAN field. |
| | Your computer or is placed too far away from the EXPLORER 710. | Bring the computer closer to the EXPLORER 710. Note that the specified maximum distance is only valid under ideal conditions. |
| The USB (Host) interface does not work. | The interface is off in the EXPLORER 710. | Enable the interface by selecting the USB interface icon in the display, or by accessing the web interface and selecting Control panel , and clicking the icon in the right side of the USB field. |

Status signalling

Means of signalling

The EXPLORER 710 system provides two methods for signalling the status of the system.

- **Status indicator** next to the display keypad
- **Messages** shown in the display and in the web interface.

Status indicator

The EXPLORER 710 has one light indicator showing status.



| Indicator pattern | | Meaning |
|-------------------|-------------------------|--|
| ● | Green flashing rapidly | Starting up |
| ● | Green flashing slowly | Power on (ready) |
| ● | Green constant | Power on with DC input |
| ● | Yellow flashing slowly | Battery charging |
| ● | Yellow flashing rapidly | Closing down |
| ● | Yellow constant | Warning (user recoverable) |
| ● | Red constant | Error. See the display or the web interface. |
| ● | Blue flashing | Uploading software to the terminal |
| ○ | Off | Power off or Stealth mode |

Messages

In the display and the web interface of the EXPLORER 710 you can see status messages and alarms that are currently active.

Click the warning symbol  to see a list of currently active alarms.

Log files

Diagnostics report

When contacting Cobham SATCOM for support, please include a diagnostic report.

The diagnostic report contains information relevant for the service personnel during troubleshooting.

To generate the diagnostic report, access the web interface and select **Control panel > Support > Diagnostics report**. Then click **Generate report**.

Call log and data log

The log holds detailed information on each call or data session to and from the EXPLORER 710, including date and time, phone numbers, duration, amount of data transferred etc.

Date and time is UTC time, received from the satellite.

For information on how to view the log in the web interface, see *Using the Log* on page 43.

Technical specifications

General specifications

| Item | Specification |
|---|---|
| Type | EXPLORER 710, BGAN Class 1 terminal |
| Max. IP data rate, Rx/Tx ^a Streaming data | 492 kbps/492 kbps (simultaneously) 32, 64, 128, 176 and 256 kbps, BGAN X-Stream, HDR, ½ channel HDR, Asynchronous HDR and ½ channel Asynchronous HDR |
| Physical dimensions | 332 x 279 x 54 mm 13.07 x 10.98 x 2.13 inches |
| Weight | 3.2 kg / 7 lbs (incl. battery) |
| Operating temperature Powered by external DC (no battery or fully charged battery) DC operated and charging the battery Powered from battery (discharging) Storage temperature Without battery With battery | -25 to 55°C 0 to 40°C -20 to 55°C -40 to 85°C 1 year at -20 to 25°C 3 months at -20 to 45°C 1 month at -20 to 60°C |
| Water & Dust Transceiver Antenna | IP52 IP66 |
| Supported web browsers (Others may be supported, these have been tested.) | Safari, Internet Explorer, Google Chrome and Mozilla Firefox |

a. Performance depends on a wide range of factors and actual usage.

Battery specifications

| Item | Specification |
|-------------------------|--------------------------------------|
| Battery type | Lithium Ion |
| Voltage | 10.95 Volt |
| Capacity | Typ. 5700 mAh |
| Time between recharging | |
| Tx time, max | 2h30m @ 144 kbps 1h30m @ 492 kbps |
| Rx time, max | 3h30m @ 492 kbps |
| Charge time | 2h. 30 min. charge time |
| Charge temperature | 0 to 40°C |
| Min. charge cycles | 300 (typically up to 500) |
| Storage temperature | |
| 1 Month | -20 to 25°C |
| 3 Months | -20 to 45°C |
| 1 Year | -20 to 60°C |

Interfaces specifications

Power input

Connector pin-out

This drawing shows the pin-out for the DC Power connector.

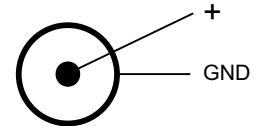

Specifications

| Item | Specification |
|-------------------|-------------------------------|
| DC input range | +10 to +32 VDC |
| Power consumption | up to 65 W depending on usage |
| Connector type | Power Jack - 2,5 mm Center |

AC/DC adapter

| Item | Specification |
|----------------|------------------------------------|
| AC input range | 100 to 240 VAC, 1.5 A, 47 to 63 Hz |
| DC output | 19 VDC, 65 W |

Phone/Fax interface

Connector pin-out

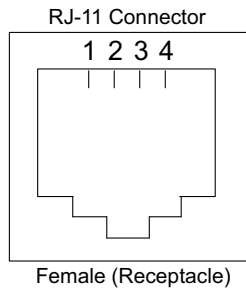

| Pin | Function |
|-----|----------|
| 1 | NC |
| 2 | Tip |
| 3 | Ring |
| 4 | NC |

Specifications

| Item | Specification |
|-------------------|----------------------------|
| Connector type | RJ-11, female |
| Impedance | 180 Ohm + 750 Ohm / 150 nF |
| Max. cable length | 100 m / 80 Ohm |

ISDN interface

Connector pin-out

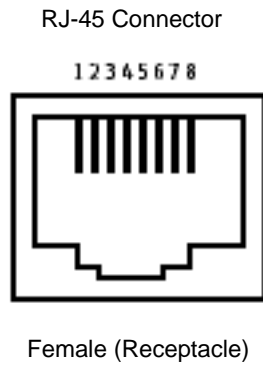

| Pin | Function |
|-----|----------|
| 1 | NC |
| 2 | NC |
| 3 | Rx+ |
| 4 | Tx+ |
| 5 | Tx- |
| 6 | Rx- |
| 7 | NC |
| 8 | NC |

Specifications

| Item | Specification |
|-------------------|---------------|
| Connector type | RJ-45, female |
| Data rate | |
| Voice | 4 kbps |
| Data | 64 kbps |
| Audio | 3.1 kHz |
| Max. cable length | 100 m |

LAN interface, 2-port

Connector pin-out

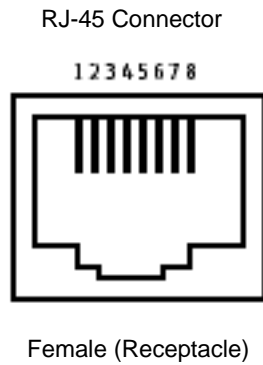

| Pin | Function |
|-----|----------|
| 1 | Rx+ |
| 2 | Rx- |
| 3 | Tx+ |
| 4 | NC |
| 5 | NC |
| 6 | Tx- |
| 7 | NC |
| 8 | NC |

Specifications

| Item | Specification |
|----------------------|---|
| Number of connectors | 2 |
| Connector type | RJ-45, female, Auto cross-over MDI/MDI-X (IEEE 802.3 10/100BaseT) |
| Standard | ISO/IEC 8877:1992 and IEEE 802.3 1998 Edition |
| Max. data rate | 10/100 Mbps |
| Max. cable length | 100 m / 328 ft with Cat5 UTP |

WLAN access point

Specifications

| Item | Specification |
|-----------------------|---|
| Standard | IEEE 802.11 b/g |
| Antenna | External rotatable antenna for increased coverage |
| Frequencies | 2.4 GHz ISM band |
| Max. coverage outdoor | 100 m / 328 ft |

USB (Host) interface

Connector pin-out

| Pin | Function |
|-----|----------|
| 1 | VBUS |
| 2 | D- |
| 3 | D+ |
| 4 | GND |

Specifications

| Item | Specification |
|--------------------------|---------------------------------|
| Version | USB v2.0 Host |
| Connector type | Type A |
| Charge current available | 0.5 A or 2.0 A, user selectable |
| Max. cable length | 5 m / 16.4 ft |

Antenna interface on transceiver

Specifications

| Item | Specification |
|------------------------------|---|
| Connector type | TNC, female |
| Max. cable length | Typically up to 100 m depending on the cable type |
| Max. cable loss | Max 20 dB cable loss at 1.5 to 1.7 GHz |
| Max. DC impedance for cables | Max. 1.4 Ohm DC resistance. |

Detachable antenna

Specifications

| Item | Specification |
|----------------|---|
| Type | Directional patch array, manually adjustable |
| Polarization | RHCP, Right-hand circular polarization for both tx and rx |
| Connector type | TNC |
| Frequencies | |
| Inmarsat | |
| Transmit | 1626,5 MHz - 1660,5 MHz and 1668 MHz - 1675 MHz |
| Receive | 1518 MHz - 1559 MHz |
| GNSS | GPS and Glonass |
| EIRP | Nominal: 20.0 dBW (EIRP), Class 1 |

B

BGAN Broadband Global Area Network. A satellite network based on geostationary satellites, delivering data rates of up to 492 kbps and telephony to virtually any part of the earth, with full UMTS (3G) compatibility. BGAN enables users to access e-mail, corporate networks and the Internet, transfer files and make telephone calls.

D

DHCP Dynamic Host Configuration Protocol. A protocol for assigning dynamic IP addresses to devices on a network. With dynamic addressing, a device can have a different IP address every time it connects to the network.

DNS Domain Name System. A system translating server names (URLs) to server addresses.

F

FCC Federal Communications Commission. An independent agency of the United States government. The FCC works towards six goals in the areas of broadband, competition, the spectrum, the media, public safety and homeland security.

G

GMPCS Global Mobile Personal Communications Services

GNSS Global Navigation Satellite System. A navigation satellite system using the GPS, GLONASS, Galileo or Beidou system.

H

HDR High Data Rate. A BGAN service supporting a portfolio of four new streaming rates, including asymmetric services.

I

IC Industry Canada (French: Industrie Canada) is the department of the Government of Canada with a mandate of fostering a growing, competitive, knowledge-based Canadian economy.

| | |
|----------|--|
| IMSO | International Maritime Satellite Organisation. An intergovernmental body established to ensure that Inmarsat continues to meet its public service obligations, including obligations relating to the GMDSS. |
| IP | Ingress Protection. An international classification system for the sealing effectiveness of enclosures of electrical equipment against the intrusion into the equipment of foreign bodies (i.e. tools, dust, fingers) and moisture. This classification system uses the letters "IP" |
| IP | Internet Protocol. The method or protocol by which data is sent from one computer to another on the Internet. |
| ISDN | Integrated Services Digital Network. A circuit-switched telephone network system, designed to allow digital transmission of voice and data over ordinary telephone copper wires, resulting in higher quality and speed than are available with analog. |
| L | |
| LAN | Local Area Network. A computer network covering a small physical area, like a home, office, school or airport. The defining characteristics of LANs, in contrast to wide-area networks (WANs), include their usually higher data-transfer rates, smaller geographic area, and lack of a need for leased telecommunication lines. |
| N | |
| NAT | Network Address Translation. An Internet standard that enables a local-area network to use one set of IP addresses for internal traffic and a second set of addresses for external traffic. A NAT module makes all necessary address translations. |
| P | |
| PBX | Private Branch Exchange, telephone exchange that serves a particular business or office. |
| PIN | Personal Identification Number. A code number used to provide access to a system that has restricted access. |
| PoE | Power over Ethernet. A standard for combining power supply with transmission of data over the Ethernet. The source unit "injects" power into the Ethernet cable and the power is "picked up" at the connected device. |
| PPPoE | Point-to-Point Protocol over Ethernet. A network protocol for encapsulating Point-to-Point Protocol (PPP) frames inside Ethernet frames. By using PPPoE, users can virtually "dial" from one machine to another over an Ethernet network, establish a point to point connection between them and then securely transport data packets over the connection. |

R

RF Radio Frequency. Electromagnetic wave frequencies between about 3 kilohertz and about 300 gigahertz including the frequencies used for communications signals (radio, television, cell-phone and satellite transmissions) or radar signals.

S

SIM Subscriber Identity Module. The SIM provides secure storing of the key identifying a mobile phone service subscriber but also subscription information, preferences and storage of text messages.

SIP Session Initiation Protocol. An application-layer control (signaling) protocol for creating, modifying, and terminating sessions with one or more participants. Used e.g. for Internet telephony.

U

USB Universal Serial Bus. A specification to establish communication between devices and a host controller (usually personal computers). USB is intended to replace many varieties of serial and parallel ports. USB can connect computer peripherals such as mice, keyboards, digital cameras, printers, personal media players, flash drives, and external hard drives.

UTC Coordinated Universal Time. The International Atomic Time (TAI) with leap seconds added at irregular intervals to compensate for the Earth's slowing rotation. Leap seconds are used to allow UTC to closely track UT1, which is mean solar time at the Royal Observatory, Greenwich.

W

WLAN Wireless Local Area Network.

Numerics

- 2-wire
 - connect a phone, 29
 - connector, 71

A

- AC/DC adapter specifications, 70
- access to settings
 - limit in web interface, 56
- advanced settings, 54
- alarm list
 - view in display, 33
 - view in web interface, 51
- analogue phone
 - connect, 29
- antenna
 - connect, 14
 - connector, 75
 - detach, 9
 - fixed, 18
 - point, 16
 - separate from transceiver, 9
 - short description, 6
- APN
 - set up, 47
- automatic activation, 47
- automatic shut down
 - connection, 55

B

- battery
 - capacity display accuracy, 60
 - charge, 59
 - hot-swap, 59
 - insert, 11
 - remove, 12
 - short description, 7
- brightness in display, 33

C

- call log, 43

- calls
 - make, 31
 - missed, received, outgoing, 43
 - total usage, 43
- charge
 - EXPLORER 710 batteries, 59
 - smartphone or tablet, 32
- clear logs, 55
- configuration
 - IP handsets and smartphones, 50
 - ISDN, 48
 - LAN, 44
 - phone interface, 48
 - USB, 49
 - WLAN, 45
- connect a phone
 - Phone interface, 29
 - WLAN or LAN, 27
- connect interfaces
 - LAN, 25
 - WLAN, 24
- connect power, 14
- connection
 - automatic shut down, 55
- connectors, 13
 - antenna, 75
 - DC input, 70
 - ISDN, 72
 - LAN, 73
 - Phone/Fax, 71
 - USB Host, 74

D

- data
 - log, 43
 - Standard, definition, 23
 - start or stop connection, 26
 - Streaming definition, 23
 - total usage, 43
- data limits, set, 55
- DC input
 - connect, 14
 - connector, 70
- default IP address, 36
- delivery contents, 8
- detach the antenna, 9

diagnostics report
 create, 51
disable interfaces, 21
display
 adjusting brightness, 33
 menu overview, 6
 not readable, 61
disposal, 60

E

enable interfaces, 21
Ethernet connector, 73

F

fixed installation, 18
forward port, 46

G

GPS
 troubleshooting, 63

H

hot-swap EXPLORER 710 batteries, 59

I

included items, 8
indicator, Status LED, 66
initial inspection, 8
insert battery, 11
insert SIM card, 11
interfaces
 enable or disable, 21
internet connection mode
 setting, 47
IP address
 for web interface, 36
IP handset
 connect, 27
 enable or disable in EXPLORER 710, 50
 manage in EXPLORER 710, 50
 SIP settings, 27
 user name and password, 50

IP header compression, 47
ISDN
 configure, 48
 connect phone or modem, 30
 connector, 72
items included, 8

L

LAN
 automatic activation of, 47
 configure, 44
 connect a computer, 25
 connect an IP handset, 28
 connectors, 73
 user group settings, 47
latch for transport, 9
LED on front panel, 66
light indicator, 66
limit
 allowed kB, 55
 allowed time, 55
 data, 55
limiting user access, 56
log of data connections, 43
logs, clear, 55

M

maximum for data, 55
menu in display, 6
modem mode, 47

N

navigation in web interface, 38
network settings
 LAN and WLAN, 47

P

password
 smartphone or IP handset, 50
permissions
 setting for users, 56

- phone
 - configure, 48
 - connect to LAN or WLAN, 27
 - connect to Phone interface, 29
 - connector, 71
 - SIP settings, 27
 - phone call, 31
 - Phone/Fax connector, 71
 - PIN
 - changing, 56
 - enabling or disabling, 56
 - point the antenna, 16
 - point the antenna again, 18
 - pointing process
 - restarting, 18
 - port forwarding, 46
 - power
 - connecting, 14
 - Power connector, 70
 - power supply
 - AC/DC adapter, 70
- R**
- remove battery, 12
 - remove SIM card, 12
 - repoint the antenna, 18
 - report
 - diagnostics, 51
 - rights for users
 - in web interface, 56
 - router mode, 47
- S**
- safety summary, iii
 - separate antenna form transceiver, 9
 - settings
 - limit access, 56
 - SIM card
 - insert, 11
 - remove, 12
 - short description, 7
 - SIP settings, 27
 - smartphone
 - charge via USB, 32
 - connect for calls, 27
 - enable or disable in EXPLORER 710, 50
 - manage in EXPLORER 710, 50
 - SIP settings, 27
 - user name and password, 50
 - software
 - update with USB, 58
 - update with web interface, 52
 - view current version, 34
 - Standard data
 - definition, 23
 - start data connection, 26
 - storage, 60
 - Streaming data
 - definition, 23
- T**
- tablet
 - charge via USB, 32
 - total usage, 43
 - transport latch
 - opening, 9
 - troubleshooting, 61
 - troubleshooting guide, 61
 - typography used in this manual, vi
- U**
- update software, 52
 - USB
 - update software, 58
 - usage
 - calls and data, 43
 - USB
 - charge smartphone or tablet, 32
 - configure, 49
 - connector, 74
 - user group settings
 - LAN and WLAN, 47
 - user name
 - smartphone or IP handset, 50
 - user permissions
 - setting up in web interface, 56

W

warranty, 57

web interface

- accessing, 36

- definition, 36

- navigating, 38

what's in the delivery, 8

WLAN

- automatic activation of, 47

- configure, 45

- connect to, 24

- user group settings, 47