

EXPLORER[®] 727 Including 19" Rack Version

INSTALLATION MANUAL

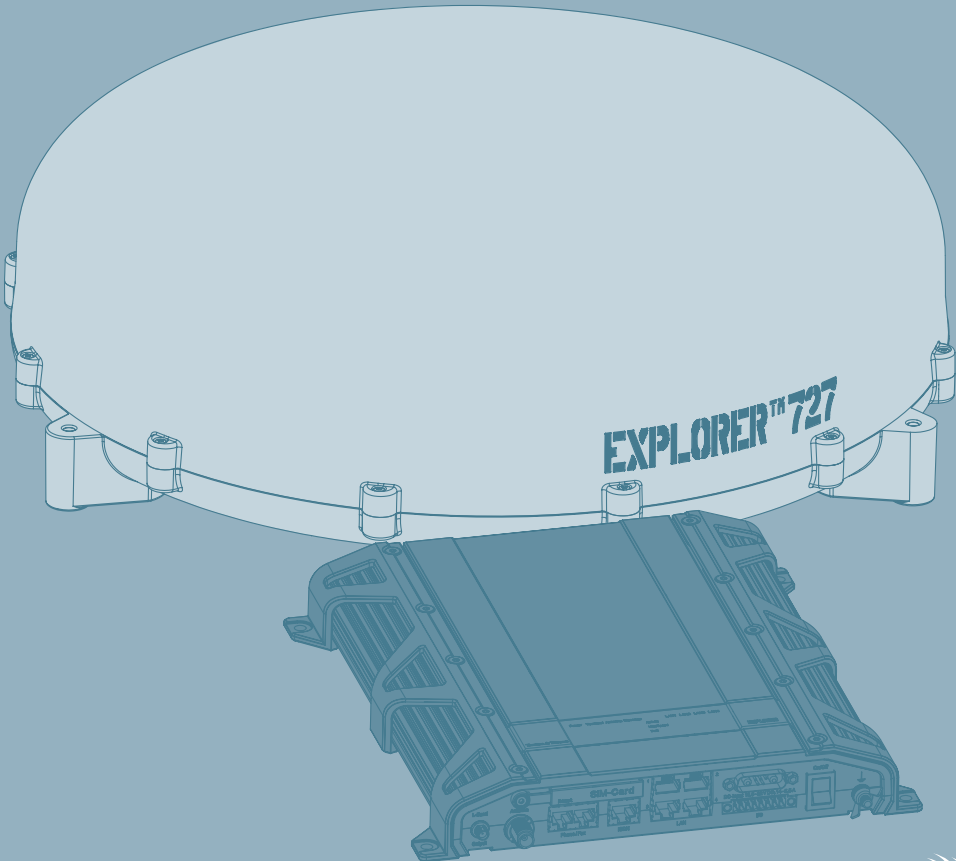

EXPLORER[®] 727
Including 19" Rack Version

Installation manual

Document number: TT98-126844-C

Release date: February 5, 2009

Disclaimer

Any responsibility or liability for loss or damage in connection with the use of this product and the accompanying documentation is disclaimed by Thrane & Thrane. The information in this manual is provided for information purposes only, is subject to change without notice and may contain errors or inaccuracies. Manuals issued by Thrane & Thrane are periodically revised and updated. Anyone relying on this information should acquire the most current version e.g. from the Thrane & Thrane Extranet at: <http://extranet.thrane.com>. Thrane & Thrane is not responsible for the content or accuracy of any translations or reproductions, in whole or in part, of this manual from any other source.

Trademark acknowledgements

- **Thrane & Thrane** is a registered trademark of Thrane & Thrane A/S in the European Union and the United States.
- **EXPLORER** is a registered trademark of Thrane & Thrane A/S in the European Union and the United States.
- **Windows** and **Outlook** are registered trademarks of Microsoft Corporation in the United States and other countries.
- **Inmarsat** is a registered trademark of International Maritime Satellite Organisation (IMSO) and is licensed by IMSO to Inmarsat Limited and Inmarsat Ventures plc.
- Inmarsat's product names are trademarks or registered trademarks of Inmarsat.
- Other product and company names mentioned in this manual may be trademarks or trade names of their respective owners.

Safety summary

The following general safety precautions must be observed during all phases of operation, service and repair of this equipment. Failure to comply with these precautions or with specific warnings elsewhere in this manual violates safety standards of design, manufacture and intended use of the equipment. Thrane & Thrane A/S assumes no liability for the customer's failure to comply with these requirements.

Observe marked areas

Under extreme heat conditions do not touch areas of the terminal or antenna that are marked with this symbol, as it may result in injury.



Microwave radiation hazards

During transmission the antenna in this system radiates microwave power. This radiation may be hazardous to humans close to the antenna. When the system is powered, make sure that nobody gets closer than the recommended minimum safety distance.

The minimum safety distance is 1 m to the side and above the antenna when the EXPLORER 727 is powered. The safety distance of 1 m does not apply directly below the antenna, as the radiation forms a hemisphere above the antenna.



Service

User access to the interior of the system units is prohibited. Only a technician authorized by Thrane & Thrane A/S may perform service - failure to comply with this rule will void the warranty.

Do not service or adjust alone

Do not attempt internal service or adjustments unless another person, capable of rendering first aid resuscitation, is present.

Power supply

The voltage range is 10.5 - 32 V DC; 14 A - 5.5 A. Be aware of high start-up peak current: 20 A at 24 V, 5 ms.

Do not operate in an explosive atmosphere

Do not operate the equipment in the presence of flammable gases or fumes. Operation of any electrical equipment in such an environment constitutes a definite safety hazard.

Keep away from live circuits

Operating personnel must not remove equipment covers. Component replacement and internal adjustment must be made by qualified maintenance personnel. Do not replace components with the power cable connected. Under certain conditions, dangerous voltages may exist even with the power cable removed. To avoid injuries, always disconnect power and discharge circuits before touching them.

Install and use the antenna with care

Thrane & Thrane A/S assumes no liability for any damage caused by the antenna falling off the vehicle or stressing the mounting base. It is the responsibility of the customer to ensure a safe and correct installation of the antenna. The instructions in this manual are only guidelines.

Failure to comply with the rules above will void the warranty!

About the manual

Intended readers

This is an installation manual for the EXPLORER 727 system. The readers of the manual include installers of the system and service personnel. Personnel installing or servicing the system must be properly trained and authorized by Thrane & Thrane. It is important that you observe all safety requirements listed in the beginning of this manual, and install the system according to the guidelines in this manual.

Manual overview

Note that this manual does not cover general use of the system nor does it cover how to use the IP handset that comes with the system. For this information, refer to the user manual for this system and the user manual for the IP handset, both listed in the next section.

This manual has the following chapters:

- **System units** contains a short description of each main unit in the system.
- **Installing the system** describes where to place the system units, how to mount them, distance to other equipment etc.
- **Connecting power** explains how to connect the terminal to power and gives recommendations for cables.
- **Hardware interfaces** describes each interface on the terminal and shows pin-out for the connectors.
- **Starting up the system** explains how to insert the SIM card, power up the system and enter the PIN. It also gives a short overview of how to use the system.
- **Troubleshooting** describes the function of the Reset button and the light indicators on the terminal. It also describes event messages that may appear in the web interface.

Related documents

The below list shows the documents related to this manual and to the EXPLORER 727 system.

Title and description	Document number
EXPLORER 727 Including 19" Rack Version User Manual Explains how to set up and use the EXPLORER 727 system.	TT98-126882
EXPLORER 727 Quick Guide A short guide to the most important functions of the EXPLORER 727 system.	TT98-126881
EXPLORER 727 Getting Started Explains how to start up your EXPLORER 727 system and make the first call or data session.	TT98-126880
Thrane IP Handset, User Manual Explains the features and functions of the Thrane IP Handset. The IP handset works as a standard IP handset, but also serves as a user interface for the EXPLORER 727 system.	TT98-126059

Typography

In this manual, typography is used as indicated below:

Bold is used for the following purposes:

- To emphasize words.
Example: “Do **not** touch the antenna”.
- To indicate what the user should select in the user interface.
Example: “Select **Settings** > **LAN**”.

Italic is used to emphasize the paragraph title in cross-references.

Example: “For further information, see *Connecting Cables* on page...”.

Table of contents

Chapter 1	System units	
	1.1 Introduction	1
	1.2 Terminal	1
	1.3 Antenna	3
	1.4 Thrane IP Handset & Cradle	4
Chapter 2	Installing the system	
	2.1 Unpacking	7
	2.2 Placing the antenna	8
	2.3 Installing the antenna	9
	2.4 Placing the terminal	18
	2.5 Installing the EXPLORER® 727 terminal	20
	2.6 Installing the EXPLORER® 727 19" Rack Terminal	23
Chapter 3	Connecting power	
	3.1 Power source	27
	3.2 Power cable selection	28
	3.3 Connecting power	33
Chapter 4	Hardware interfaces	
	4.1 The connector panel	37
	4.2 Antenna interface on terminal	38
	4.3 DC power input	39
	4.4 19" rack version only: Terminal block	41
	4.5 Analog Phone/Fax interface	42

4.6	ISDN interface	43
4.7	LAN interface	45
4.8	Discrete I/O interface	47
Chapter 5	Starting up the system	
5.1	Using the SIM card	51
5.2	Powering the system	53
5.3	Entering the SIM PIN for the terminal	57
5.4	Operating the system	59
Chapter 6	Troubleshooting	
6.1	Reset button	61
6.2	Status signaling	64
6.3	Logging of events	69
App. A	Part numbers	
A.1	System units	71
A.2	Spare parts	71
App. B	Technical specifications	
B.1	Overview	73
B.2	Antenna	74
B.3	Terminal	78
Glossary	87
Index	91

System units

1.1 Introduction

The basic system consists of three units: The terminal, the antenna and the IP handset with cradle.

1.2 Terminal

The terminal is the central unit in the system. It contains all user interfaces and handles all communication between the BGAN antenna and the local communication units (phones, computers etc.).

The terminal comes in two versions, one designed for wall or desktop installation, and one designed for installation in a 19" rack.

Below is the terminal for wall or desktop installation.



The below drawing shows the 19" rack version of the terminal.



The terminal supplies 23.0 - 30.0 V DC to the antenna through a single coaxial cable.

The DC input for the terminal is designed for both 24 V DC and 12 V DC power supply.

1.3 Antenna

The EXPLORER 727 antenna is a mechanical tracking antenna, consisting of a 2-axis stabilized antenna with RF-unit, antenna control unit and GPS antenna. The antenna is dedicated to the Inmarsat BGAN (Broadband Global Area Network) system and is designed for roof mounting on a vehicle. All communication between the antenna and terminal passes through a single coaxial cable.

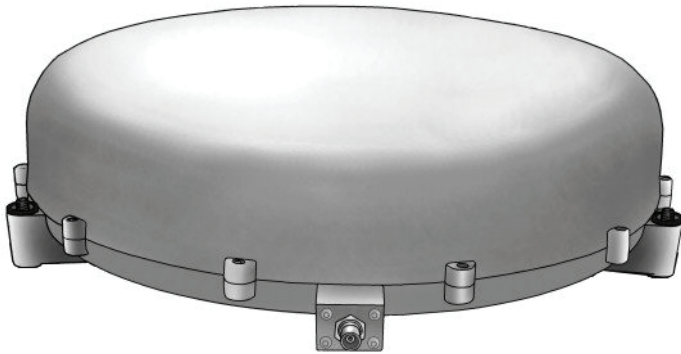

1.4 Thrane IP Handset & Cradle

1.4.1 Thrane IP Handset

Besides the normal functions of an IP handset, the Thrane IP handset also provides a user interface for the EXPLORER 727 system. The IP handset connects to the LAN interface of the terminal, and is power supplied with Power over Ethernet (PoE) through the LAN interface.



For further information on the IP handset, refer to the user manual for the Thrane IP Handset.

1.4.2 Thrane IP Cradle

The IP cradle serves as a holder for the IP handset. It is power supplied from the terminal using Power over Ethernet (PoE). The cradle connects to the handset with a coil cord and to the terminal with a standard LAN cable.

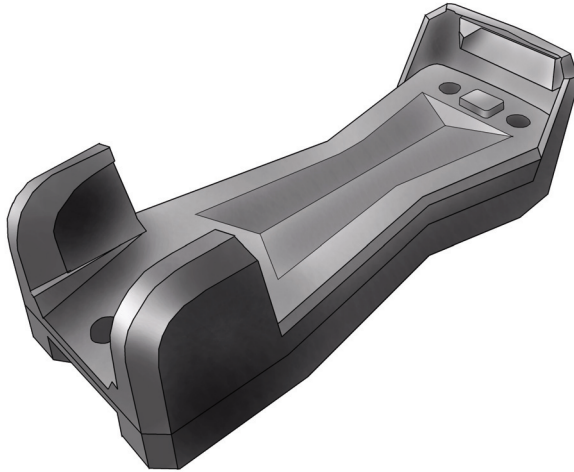

Installing the system

2.1 Unpacking

Unpack your EXPLORER 727 system and check that the following items are present:

- TT-3736A EXPLORER 727 terminal or TT-3736A-T19 EXPLORER 727 19" Rack Terminal
- TT-3053B EXPLORER 727 antenna
- TT-3670A Thrane IP Handset & Cradle, wired
- Basic cable support kit including an I/O connector or for 19" rack version: Strain Relief Bracket
- Power cable
- Antenna cable
- LAN cable
- Installation manual (this manual)
- Getting Started kit including:
 - Getting Started leaflet
 - Quick Guide
 - EXPLORER 727 CD including electronic versions of User manual, Installation manual, Quick Guide and Getting Started guide.

Inspect all units and parts for possible transport damage.

Note

For information on how to install the IP handset and cradle, refer to the user manual for the handset.

2.2 Placing the antenna

2.2.1 Obstructions

Obstructions can cause signal degradation.

The amount of degradation depends on the size of the obstruction and the distance from the antenna. As a rule of thumb any obstruction that subtends an angle of less than 3° at the antenna has limited effect. The table below gives a guideline for obstruction sizes that will cause limited degradation.

Distance of Obstruction	Size of Obstruction
3 m	16 cm
5 m	26 cm
10 m	52 cm
20 m	104 cm

2.2.2 Radiation hazard

The EXPLORER 727 antenna radiates up to 18 dBW EIRP. This translates to a minimum safety distance of 1 m from the antenna while it is transmitting. Note that the safety distance applies to a hemisphere above the antenna. The antenna does not radiate power directly below the antenna.

2.2.3 Interference

Do not place the antenna close to interfering signal sources or receivers. We recommend that no other antennas are located within three meters of the antenna. If other equipment is installed near the EXPLORER 727 we recommend testing the total system by operating all equipment simultaneously and verifying that there is no interference.

2.3 Installing the antenna

2.3.1 Antenna cables

Guidelines

A coaxial cable for connection between the antenna and terminal is delivered with the system. If you need a different cable, make sure that the cable meets the requirements. Preferably choose one of the cable types in *Recommended antenna cables* on page 9.

The maximum allowed RF-loss in the antenna cable is 20 dB at 1660 MHz. This is to ensure the performance of the system.

Recommended antenna cables

The table below shows recommended cable types and maximum cable lengths for EXPLORER 727.

Cable Type	Absolute maximum length
RG-223_U-01	14 m
RG-214_U-01	50 m
S-10162-B-11	92 m

Check in the data sheet from the cable supplier that both the RF-attenuation and the DC-resistance are kept within the maximum specified values:

- Antenna cable RF-attenuation at 1660 MHz: max. 20 dB incl. connector.
- Antenna cable modem-attenuation at 54 MHz: max. 4 dB.
Antenna cable modem-attenuation at 36 MHz: max. 3 dB.
- Antenna cable loop DC-resistance max: 0.6 Ω .

Also ensure that the specified minimum bending radius is respected. If this is not the case, the loss in the cable will increase. Check the instruction from the cable supplier. The bending radius for the coax cable delivered with the system is min. 110 mm.

2.3.2 Important mounting notes

Line of sight

Place the antenna with free line of sight in all directions to ensure proper reception of the satellite signal. Do not place the antenna close to large objects that may block the signal.

After installing and starting up the EXPLORER 727, we recommend checking the signal strength while driving the vehicle in a 360° circle to ensure a clear line of sight in all directions.

Condensation

In some cases there will be condensation inside the antenna. Gaskets in the bottom of the EXPLORER 727 antenna are designed to lead any water away from the antenna.

Make sure these draining gaskets are not blocked.

Important

Make sure there is always a distance of min. 10 mm between any part of the antenna bottom and the mounting surface. Use 10 mm spacers (or higher if necessary) at each bolt.

See the drawing in *Mounting the antenna directly on the vehicle roof* on page 17.

Safety



Caution! It is the responsibility of the customer to ensure a safe installation! See guidelines below.

Under normal driving circumstances the magnetic force of the magnetic mount kit for the antenna should be sufficient to hold the antenna. However, the magnets may not be able to hold the antenna in place, if:

- the vehicle is involved in an accident,
- the magnets are not mounted properly,
- the roof is not plain or made of a material that will not stick properly to the magnets,
- the speed of the vehicle is too high and/or
- the road is very bumpy.

We recommend mounting the antenna on the roof rails or directly on the roof instead of using the magnetic mount kit. Make sure that all mounting bolts and nuts are secured properly, and that the material of the mounting surface is strong enough to hold the antenna during the intended use.

2.3.3 Mounting the antenna

The antenna can now be installed on the roof of the vehicle with three stainless steel bolts. You may choose between three methods:

- Attach the antenna to the roof rails on your vehicle using the dedicated mounting brackets delivered with your EXPLORER 727 system.
- Attach the antenna using the magnetic mount kit from Thrane & Thrane. Mount the magnetic feet on the antenna and the magnetic force will keep the antenna fixed to the vehicle roof. Note that this method requires a vehicle roof made of magnetizable material.
- Mount the antenna directly on the roof of the vehicle. This method requires that you drill holes in the roof of the car. Remember to leave min. 10 mm space between the antenna and the roof.

Refer to the previous section, *Safety* on page 11!

2.3.4 Mounting the antenna on the roof rails on the vehicle

Overview

Using the dedicated brackets from the roof rail mount kit available from Thrane & Thrane you can attach the antenna to the roof rails on your vehicle.

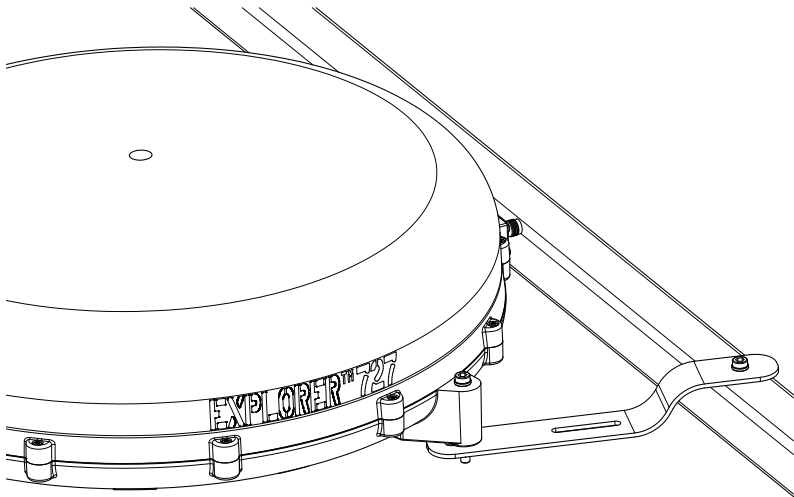

Installing the antenna on the roof rails

Do as follows:

1. Mount the brackets from the roof rail mount kit on the 3 “legs” of the antenna, using the bolts, nuts and washers from the kit.
2. Drill 3 holes in the roof rails, matching the position of the 3 brackets.

3. Mount the antenna with the brackets onto the roof rails of the vehicle, placing the bolts, nuts and washers from the kit as shown on the drawing.

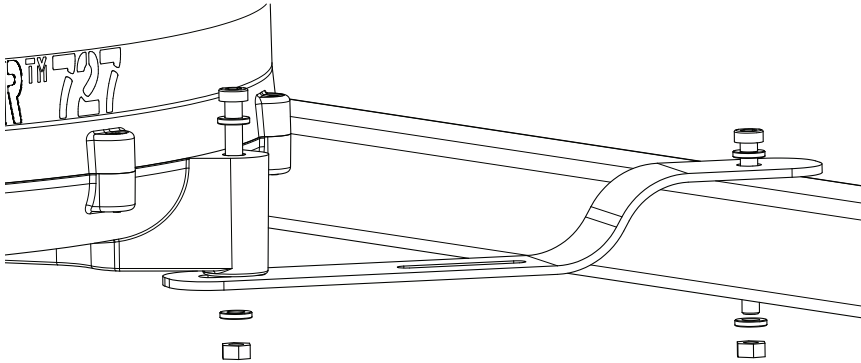

4. Tighten all bolts and nuts firmly to secure the antenna to the roof rails.
Torque for the bolts on the antenna: 7.5 Nm.
Torque for the bolts on the roof rails: 8.5 Nm.

2.3.5 Magnetic mount

Overview

For temporary use – or to avoid drilling holes – you may use the Magnetic Mount installation kit available from Thrane & Thrane.

The Magnet Mount kit consists of 3 individual high intensity magnets with rubber coating. Each magnet has an adhesive force of at least 420 N and is mounted with a stainless steel M5 center bolt.

Installing the magnetic mount kit

Note

Make sure the roof of the vehicle is made of a magnetizable material. Wipe the surface clean before placing the antenna on the roof, in order to make a better connection between the magnets and the roof and to avoid scratches in the surface.

To use the magnetic mounts, do as follows:

1. First attach the magnets to the antenna.

Important

The antenna must have a clearance of 10 mm above the base plane. If the base plane is curved, it may be necessary to place extra spacers to ensure the clearance of 10 mm.

There are 3 “legs” on the antenna. Place one magnet under each leg as shown on the drawing on the next page.

2. Tighten the bolts with 7.5 Nm torque.

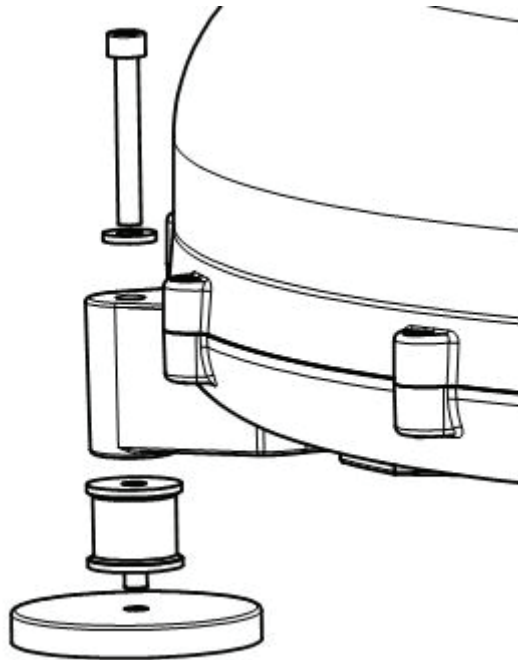

3. Place the antenna with magnets on the roof of the car. Remember that the magnets only work on a roof made of magnetizable material!

Detaching the antenna

Grab the antenna near one of the magnets and lift it. When one magnet is loose, the other two are easy to “break off”. In some situations the magnetic force may be so great that it is necessary to unscrew the antenna first and remove the magnets separately.

2.3.6 Mounting the antenna directly on the vehicle roof

The antenna may be mounted directly on the roof of your car, using three M5 bolts, spacers and rubber washers. This solution requires that you drill three holes in the roof of the car.

Important There must always be a clearance of min. 10 mm between the bottom of the antenna and the mounting surface.

Mounting accessories are included with the antenna.

Note the individual position of washers and spacers.

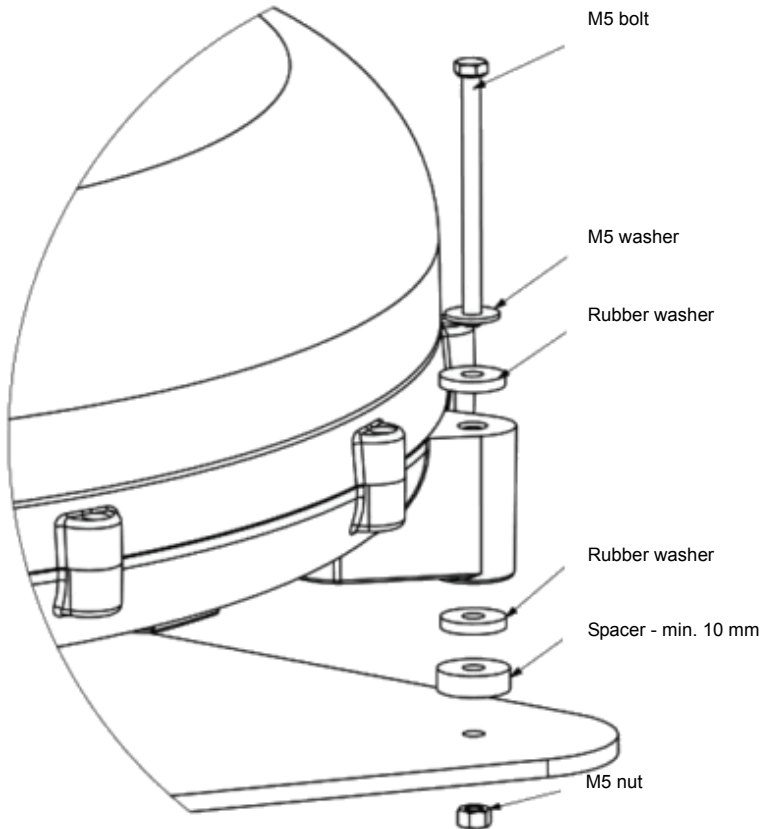

2.4 Placing the terminal

2.4.1 Overview

Because the terminal comes in two versions, the following description contains

- one section for the EXPLORER 727 terminal and
- one section for the EXPLORER 727 19" Rack Terminal.

2.4.2 Where to place the EXPLORER[®] 727 terminal

General

The terminal is designed for installation inside a vehicle. It is not suited for outdoor installation.

Temperature conditions

The terminal must be placed in a ventilated area with free space around all sides of the unit, except the bottom side.

Ambient temperature range is -25°C to $+55^{\circ}\text{C}$.

If the terminal is installed in a location where the ambient temperature may exceed 50°C , we recommend placing the terminal where unintentional contact is avoided. If the maximum ambient temperature does not exceed 50°C , the terminal can be placed in a public area.

2.4.3 Where to place the EXPLORER® 727 19" Rack Terminal

General

The terminal is designed for installation inside a vehicle. It is not suited for outdoor installation.

Temperature conditions

Ambient temperature range is -25°C to $+55^{\circ}\text{C}$.

Note

If you install other equipment close to the terminal in the rack, first make sure the equipment can withstand the heat that may be dissipated from the EXPLORER 727 19" Rack Terminal. In max. ambient temperature the surface of the terminal may reach a temperature close to 70°C .

2.5 Installing the EXPLORER[®] 727 terminal

2.5.1 Overview

Because the terminal comes in two versions, there are two sections describing installation of the terminal:

- one section for the EXPLORER 727 terminal (this section) and
- one section for the EXPLORER 727 19" Rack Terminal (*Installing the EXPLORER[®] 727 19" Rack Terminal* on page 23).

2.5.2 Mounting the Basic cable support

The Basic cable support comes with the terminal as part of the delivery.

When mounted on the terminal the Basic cable support offers a number of holders to which you can secure the cables from the terminal, using cable strips.

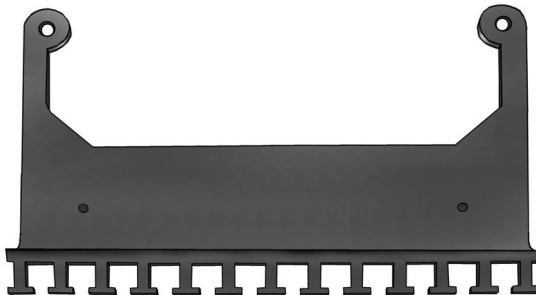

To mount the Basic cable support, do as follows:

1. Remove the two rubber feet from the bottom of the terminal at the connector panel end. The mounting bushes are underneath the rubber feet.

2. Fasten the Basic cable support to the two mounting bushes close to the connector panel on the terminal, using two M4 x 6 mm countersunk screws.

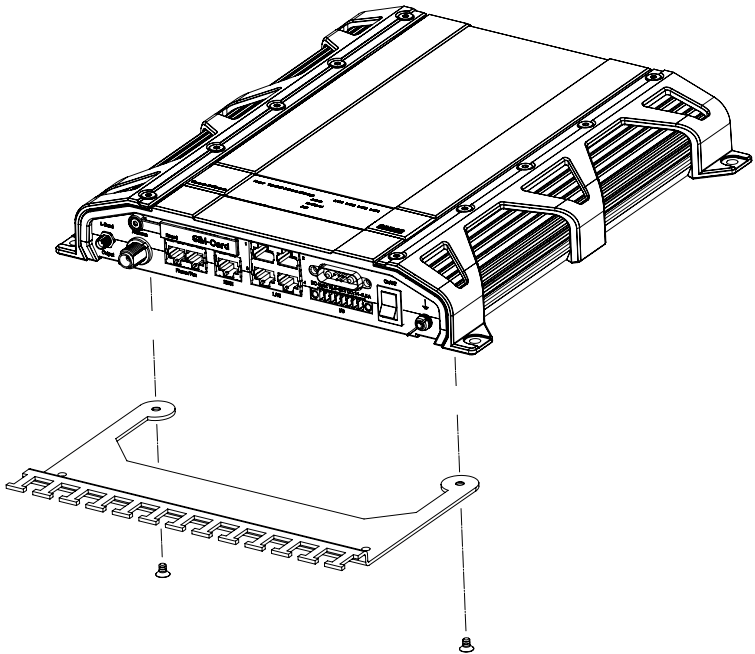

3. Install the terminal as described in *Installing the terminal* on page 25.

2.5.3 Installing the terminal

Do as follows to mount the terminal:

1. Insert four screws through the holes in the mounting bracket and into the mounting surface.

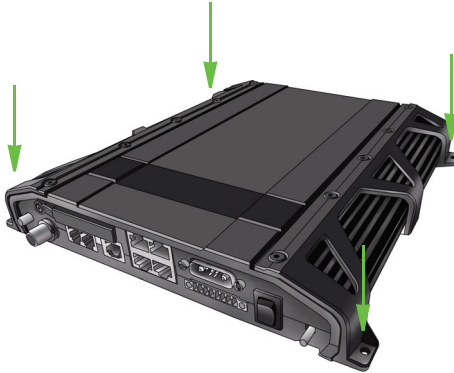

2. Connect all cables.
If you are using the cable support, secure the cables to the cable support using cable strips.

2.6 Installing the EXPLORER[®] 727 19" Rack Terminal

2.6.1 Overview

Because the terminal comes in two versions, there are two sections describing installation of the terminal:

- one section for the EXPLORER 727 terminal (the previous section) and
- one section for the EXPLORER 727 19" Rack Terminal (this section).

2.6.2 Mounting the Strain Relief Bracket

The Strain Relief Bracket comes with the terminal as part of the delivery.

When mounted on the terminal the Strain Relief Bracket offers a number of holders to which you can secure the cables from the terminal, using cable strips.

To mount the Strain Relief Bracket, do as follows:

1. Unscrew the two screws in the connector panel.

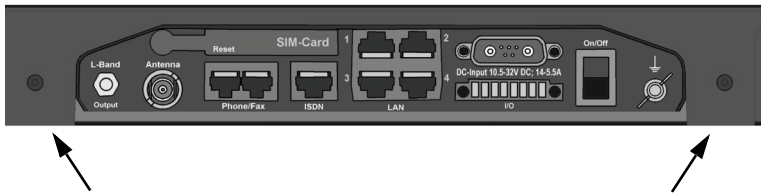

2. Fasten the Strain Relief Bracket to the terminal with the screws from step 1.

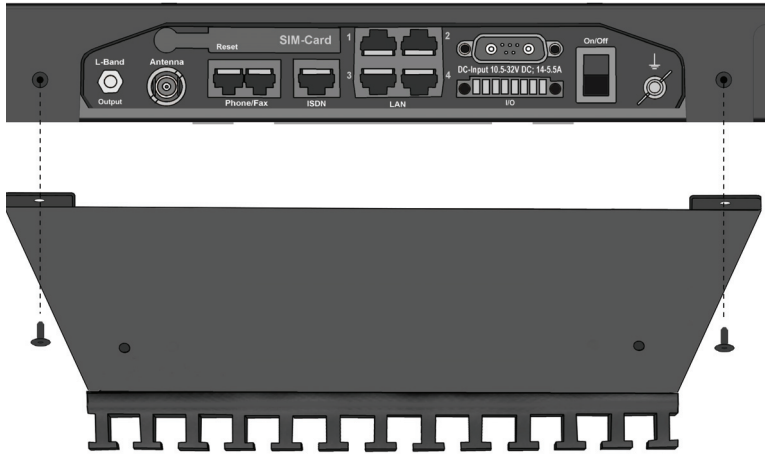

3. Install the terminal as described in *Installing the terminal* on page 25.

2.6.3 Installing the terminal

To install the terminal, do as follows:

1. Slide the terminal into a 1U space in a 19" rack.
2. Mount two screws in each side through the holes in the front and fasten the screws to the rack.
3. Connect all cables.

Note

In order to make the power switch on the front of the terminal functional, remember to connect the green and orange wires from the DC cable to the terminal block as described in the next chapter, *Connecting power*.

Connecting power

3.1 Power source

The 12 or 24 V DC supply of the vehicle provides power for the terminal.

Note

Do not use the cigarette lighter socket in the vehicle to supply power for the EXPLORER 727. Connect directly to the 12 or 24 V supply instead.

Note that the maximum allowed source impedance is much lower for a 12 V DC supply than for a 24 V DC supply. Also, the total output power available for Power over Ethernet is limited when the power supply is 12 V DC.

Be aware of high start-up peak current: 20 A at 24 V, 5 ms.

The terminal is equipped with an internal 20 A Fuse, so no external fuse is necessary in order to protect the terminal. However, in order to avoid short circuit in the power cable/connector, the DC outlet of the vehicle should be protected by a 30 A fuse or circuit breaker.

3.2 Power cable selection

3.2.1 Source impedance

The length of the power cable depends on the type of cable used and the source impedance of the DC power installation in the vehicle.

The maximum allowed source impedance depends on the utilization of the power range of the terminal DC input (10.5 - 32 V DC; 14 - 5.5 A).

Select a power outlet from the DC system and measure the source impedance of the installation as described in *Measuring the source impedance* on page 86 in Appendix B.

Note

If the total impedance is higher than the limits stated in this section, the terminal may become unstable and start to on/off oscillate.

The total impedance is made up of the source impedance of the vehicle power supply plus the impedance of connected cables including connectors and joints where cables are extended.

For further recommendations on power cable selection, see the next section.

3.2.2 Power cable recommendations

Overview

The terminal is delivered with a power cable, which can be extended according to the recommendations in this section.

- When extending the power cable, positive and negative supply wires must be installed closely together side by side to keep cable inductance low.
- Ensure that cable inductance for the selected cable at the desired length is below the 50 μH requirement.

The power cable contains the following wires:

Color of wire in power cable	Pin number in connector	Function
Red	A1	Vin+
Black	A2	Vin-
(Black)	1	not connected
Green	2	Remote on/off
(Brown)	3	not connected
(Red)	4	not connected
Orange	5	Remote on/off

The power cable for the EXPLORER 727 19" Rack Terminal is split in two, so that the Remote on/off wires are ready to connect to the front power switch.

For information on how to connect to the front power switch, see *19" rack version only: Connecting to the power switch on the front* on page 34.



The remote on/off wires can be used to connect to:

- The front power switch on the 19" rack version of the terminal, **or**
- a remote switch

For information on how to connect to a remote switch, see *Connecting a Remote on/off switch* on page 36.

Calculating the maximum power cable extension

For 24 V DC operation, the total impedance must be max. 500 m Ω , including the source impedance in the vehicle installation.

For 12 V DC operation, the total impedance must be max. 85 m Ω , including the source impedance in the vehicle installation.

The total impedance is made up of the following:

- the source impedance in the vehicle installation
- the cable impedance of the supplied power cable, including the impedance in the joint of the two cables. In the following example, the impedance of the cable and joint is set to 50 m Ω (6 m power cable). Note that if the cable length or type is changed, the impedance will change accordingly.
- the extension cable impedance.

To calculate the maximum cable extension, do as follows:

1. First measure the source impedance in the vehicle installation as shown in *Measuring the source impedance* on page 86.
2. Then find the resistance per meter for the cable type you are going to use.
For 4 mm²/AWG 11, the value is 4 m Ω /m at 20°C
For 1.5 mm²/AWG 15, the value is 10 m Ω /m at 20°C
For other cable types, refer to the data sheet for the cable.
3. Calculate the maximum allowed impedance in the extension cable as follows:
Max. allowed impedance in extension cable = max. total impedance - (measured source impedance + impedance of the supplied cable).
4. Then calculate the max. extension cable length as follows:

$$\text{Max. length} = 0.5 \times \frac{\text{Max. impedance in extension cable (from step 3)}}{\text{impedance/meter (from step 2)}}$$

The length is multiplied by 0.5 above because there are two conductors in the cable.

Example:

Note

The following example may not be applicable to your installation! For example, the source impedance of the vehicle power supply varies depending on the type of battery and the temperature.

Vehicle supply voltage: 12 V DC

Vehicle source impedance (measured): 15 mΩ

Extension cable type: 4 mm² (AWG 11)

$$\text{Max. cable extension} = 0,5 \times \frac{85\text{m}\Omega - (15\Omega + 50\text{m}\Omega)}{4\text{m}\Omega/\text{m}} = 2,5\text{m}$$

In this case, the power cable can be extended with up to 2.5 m.

If you need more length, you can double the maximum allowed length by connecting two cables in stead of one, or you can use a cable with a larger diameter.

3.3 Connecting power

3.3.1 Connecting the power cable

To connect the power cable

Do as follows to connect the power cable:

1. Connect the D-sub connector on the power cable to the DC input connector on the terminal.

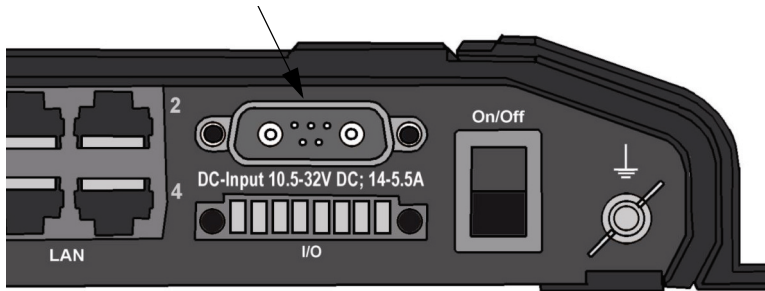

If you need a **remote on/off** function, you may use one of the following options:

- Connect the Remote on/off wires to a remote switch. **Note that this is not possible if you are using the front switch on an EXPLORER 727 19" Rack Terminal!** For further information, see *Connecting a Remote on/off switch* on page 36.
 - Connect the ignition pins in the I/O connector to the ignition of your vehicle. For further information, see *Connecting to the ignition* on page 35.
2. Connect the red (+) and black (-) wires of the power cable to the DC supply according to the recommendations in the previous sections.

For information on pin-out, see *DC power input* on page 39.

For specifications of the DC input on the terminal, see *Terminal* on page 78.

19" rack version only: Connecting to the power switch on the front

The EXPLORER 727 19" Rack Terminal has a power switch on the front in addition to the switch in the connector panel.



The power cable included in the delivery is prepared for connection to the front switch. It has two separate wires (one green, one orange), which can be connected to the terminal block.



If you want to use the power switch on the front of the terminal to switch the terminal on and off, connect the remote on/off pins in the DC connector to the terminal block in the connector panel as follows:

1. Press with a small screwdriver at one of the two terminals in the terminal block to open the terminal. Then insert the end of the green wire into the terminal and remove the screwdriver.

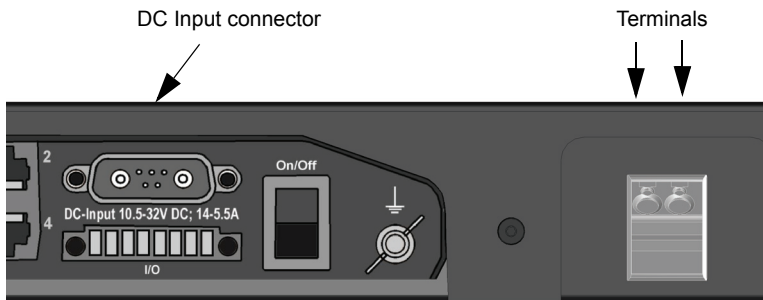

2. Press with a screwdriver on the other terminal in the terminal block and insert the end of the orange wire into the terminal.

3.3.2 Connecting to the ignition

The terminal has an ignition function. When this function is used, the terminal switches on/off when you start/stop the engine of your vehicle (provided both power switches on the terminal are on).

Use the web interface to configure the ignition function according to your needs. In the web interface, select **SETTINGS > Discrete I/O**. Select if the Ignition pin should be “Active high” or “Active low” and set up a delay determining how long the terminal will stay on after switching the ignition off. For further information on the web interface, see the user manual for the EXPLORER 727 system.

To implement the ignition function, connect the appropriate pin in the I/O connector to the ignition key switch:

- Active high (default): Connect pin 5 to Ground. Connect pin 8 to “high” (10.5-32 V DC) when the ignition is on.

- Active low: Connect pin 8 to positive DC voltage (10.5-32 V DC). Connect pin 5 to Ground (< 1.2 V DC) when the ignition is on.

Pin-out and default functions: *Discrete I/O interface* on page 47.

Standby current when the ignition power is off: See *Standby current* on page 80.

3.3.3 Connecting a Remote on/off switch

The terminal has a remote on/off function. When the terminal power switch is in the “on” position you can remote-control the power function.

Note

The remote on/off function is not available if you have connected the front power switch on an EXPLORER 727 19” Rack Terminal.

By installing a switch that can short-circuit the “Remote on/off” pins (2 and 5) in the power connector you can power the terminal on or off with this remote switch.

When pins 2 and 5 are not short-circuited and valid input power is present, the terminal is powered on, provided the Power switch is in the “on” position.

For pin-out for the power connector and a description of the wire colors in the power cable, see *Pin-out* on page 40.

For information on the standby current when the remote on/off switch is off, refer to *Standby current* on page 80 in the *General specifications (including 19” rack version)*.

Hardware interfaces

4.1 The connector panel

The connector panel is placed at one end of the terminal and has the following connectors:

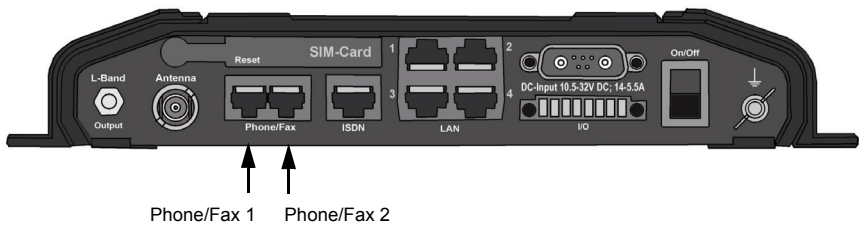

- 1 L-Band connector (not currently used)
- 1 Antenna connector (TNC)
- 2 Phone/Fax connectors (Port 1 is closest to the antenna connector)
- 1 ISDN connector
- 4 LAN connectors with Power over Ethernet (PoE)
- 1 DC power input connector for connection to 10.5-32 V DC, with optional remote on/off
- 1 Input/Output connector with 5 inputs/outputs for external control or signaling
- 1 ground stud with wing nut
- 19" rack version only: 1 terminal block with 2 terminals for connection to front power switch

For information on how to connect to a specific interface, see the next sections.

4.2 Antenna interface on terminal

4.2.1 Overview

The antenna interface on the terminal connects to the TT-3053B antenna in the EXPLORER 727 system.

The antenna connector on the terminal is a TNC female connector placed in the connector panel.

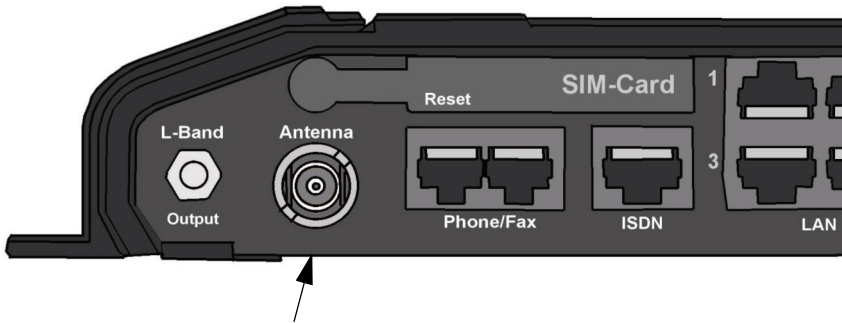

For information on cables and how to install and connect the antenna, see *Installing the antenna* on page 9.

4.2.2 Pin-out

The below drawing shows the TNC female connector in the terminal.

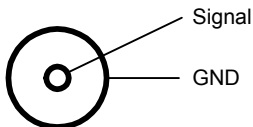

4.3 DC power input

4.3.1 Overview

The DC power input for the terminal is a 10.5 - 32 V DC; 14 - 5.5 A input with a remote on/off function. The input is protected against reverse polarity.

The power connector is a D-sub connector placed in the connector panel.

Important

On the EXPLORER 727 19" Rack Terminal, do **not** connect power to the terminal block in the right side of the connector panel! The terminal block is only for connection of the remote on/off signal.

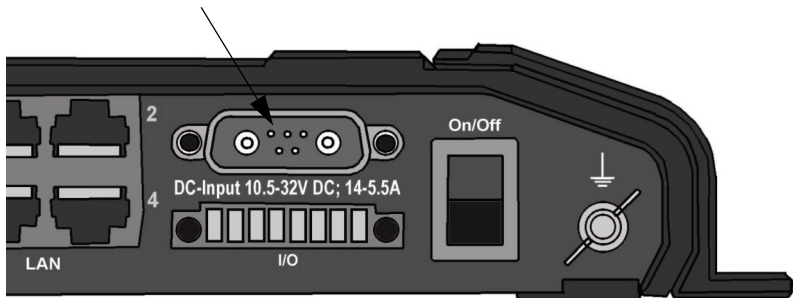

For information on power recommendations and how to connect, see *Connecting power* on page 27.

For EXPLORER 727 19" Rack Terminal: To be able to use the power switch on the front panel of the terminal you must connect the remote on/off pins in the DC connector to the terminal block in the right side of the connector panel. For further information, see *19" rack version only: Connecting to the power switch on the front* on page 34.

4.3.2 Pin-out

The power connector is a Mixed D-Sub connector 7W2, control pin male/ power pin male. The below table shows the pin-out for the connector and the colors of the corresponding wires.

Pin number	Pin function	Color of wire in power cable
A1	Vin+	Red
A2	Vin-	Black
1	not connected	(Black)
2	Remote on/off	Green
3	not connected	(Brown)
4	not connected	(Red)
5	Remote on/off	Orange

Mixed D-Sub connector, 7W2, male

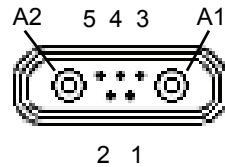

4.4 19" rack version only: Terminal block

The terminal block in the connector panel is used to connect the remote on/off pins from the DC connector to the power switch in the front of the terminal.

Important | Do **not** connect power to the terminal block!

Connection for power switch on front panel

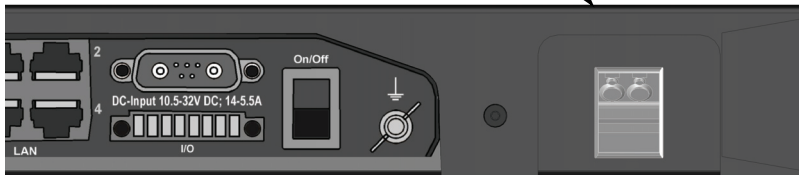

For information on how to connect, see *19" rack version only: Connecting to the power switch on the front* on page 34.

4.5 Analog Phone/Fax interface

4.5.1 Overview

The terminal has two RJ-11 ports, which can be used for connection of analog phones, fax machines or analog modems.

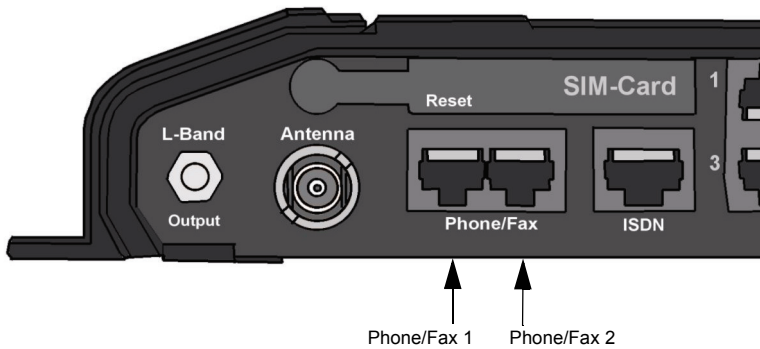

4.5.2 Pin-out

The Phone/Fax connectors are RJ-11, 6/4 female connectors. The table and figure below show the connector outline and pin assignments.

Pin number	Pin function
1	-
2	not connected
3	Tip
4	Ring
5	not connected
6	-

RJ-11 female connector

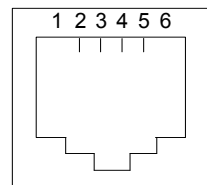

4.6 ISDN interface

4.6.1 Overview

The terminal has one ISDN connector for connecting an ISDN phone or an ISDN modem. The ISDN interface supports 56/64 kbps data rate. It is configured as the network side, i.e. Rx is an input and Tx is an output.

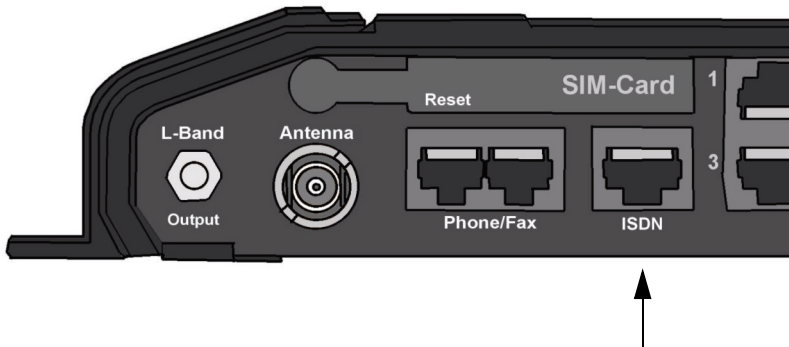

4.6.2 Pin-out

The figure and table below show the connector outline and pin assignments.

Pin number	Pin function
1	not connected
2	not connected
3	Rx+ (c) input
4	Tx+ (d) output
5	Tx- (e) output
6	Rx- (f) input
7	not connected
8	not connected

RJ-45 female connector

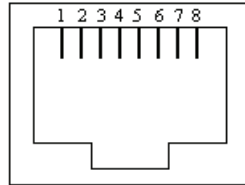

4.7 LAN interface

4.7.1 Overview

The terminal has four Ethernet LAN ports with Power over Ethernet (PoE). The Ethernet ports are standard IEEE 802.3 af ports using RJ-45 connectors.

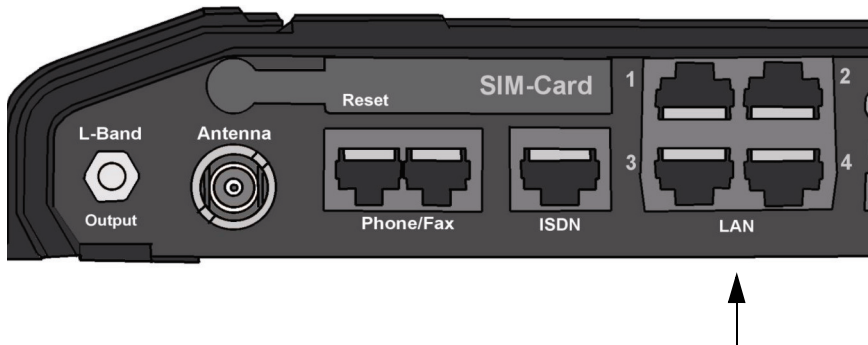

4.7.2 Power over Ethernet (PoE)

One power supply powers all four interfaces with a floating 48 V DC supply (44 - 57 V DC). Therefore, the interfaces are not galvanically separated from each other. All Tx signals are DC connected to the Positive PoE Voltage and all Rx signals to the Negative PoE Voltage.

The total output power from all 4 interfaces is

- 64 W at 24 V DC power supply
- 32 W at 12 V DC power supply

All interfaces can support devices of power class 1, 2 and 3 (4, 7 and 15.4 Watt), as long as the total power consumption does not exceed the above limits. If the limits are exceeded, the LAN ports are prioritized so that LAN port 1 has the highest priority. For example, if all ports are used and the total power consumption is too high, port 4 is closed down.

In case of power hold-up (failure on input power), PoE will be turned off.

4.7.3 Pin-out

The figure and table below show the connector outline and pin assignments.

Pin number	Pin function
1	TxD+ input (positive PoE)
2	TxD-input (positive PoE)
3	RxD+ output (negative PoE)
4	not connected
5	not connected
6	RxD- output (negative PoE)
7	not connected
8	not connected

RJ-45 female connector

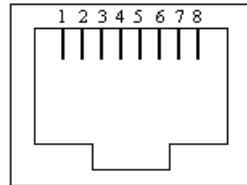

4.7.4 Connecting the Thrane IP handset

To connect the Thrane IP Handset to the terminal, do as follows:

Connect the cable from the IP cradle to one of the LAN connectors on the terminal. For information on how to install the IP handset, refer to the user manual for the handset.

The maximum length of the cable between IP cradle and terminal is 80 m.

Note

If you insert a switch or similar between the cradle and the terminal, make sure that it conforms to the industry standard **IEEE 802.3 af (using data pairs)**.

4.8 Discrete I/O interface

4.8.1 Overview

The terminal has an I/O connector with 5 configurable inputs/outputs.

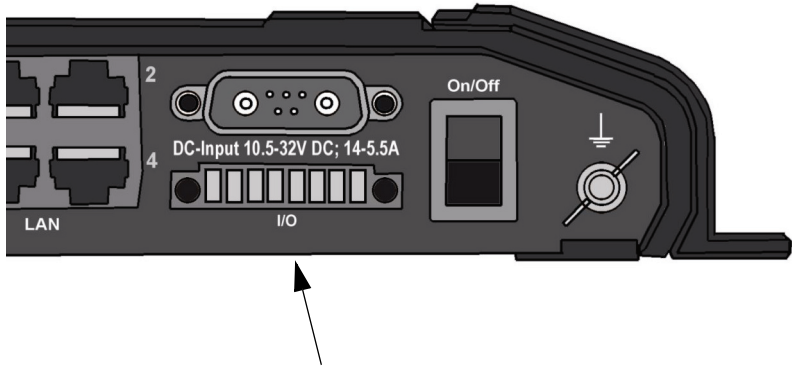

The connector is a WieCon Type 8513S connector.
A mating I/O connector is included in the delivery.

4.8.2 Pin-out

The figure and table below show the connector outline and pin assignments.

WieCon Type 8513S connector

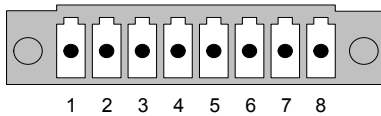

Pin number	Connection	Default configuration ^a
1	GPIO 1	Ringer output, active high
2	GPIO 2	Warning/Error output
3	GPIO 3	Mute output
4	GPIO 4	Radio silence input
5	GPIO 5	Ignition input
6	Chassis GND	Chassis GND
7	DC out	9-15 V DC, 50 mA
8	DC in	(ignition input)

- a. The default functions of the I/O pins are described in the next section.

4.8.3 Default configuration of I/O pins

The built-in web interface of the terminal offers a page for configuring the I/O pins.

The default configuration of the I/O pins is as follows:

- **Pin 1: Ringer output.**
(Default setting: Normally open)
Pin 1 acts as a built-in switch in the terminal. By default, this pin is internally connected to Ground when the terminal is notified of an incoming call from the satellite interface. When the call is answered, or the caller gives up and releases the call, the pin is disconnected (open).
- **Pin 2: Warning/Error output.**
(Default setting: Normally open)
Pin 2 acts as a built-in switch in the terminal. By default, this pin is internally connected to Ground when there is an active warning/error condition in the terminal. The pin stays connected to ground until all warnings/errors are cleared.
- **Pin 3: Mute output.**
(Default setting: Normally open)
Pin 3 acts as a built-in switch in the terminal. By default, this pin is internally connected to Ground as long as there is a phone call in progress. This signal can be used to mute external equipment. When the call is released, the pin is disconnected (open).
- **Pin 4: Radio silence input.**
(Default setting: Active Low)
By default, pin 4 is activated when externally connected to Ground. When pin 4 is activated, the terminal observes Radio Silence. The terminal gracefully closes all open connections, and deregisters from the BGAN network. No transmission is allowed until the pin is deactivated (disconnected from Ground).
- **Pin 5/8: Ignition input.**
(Default setting: Active high)
The ignition function can be used to turn on/off the terminal by means of an external signal. The ignition function uses pin 5 together with pin 8 (DC in). Connect the appropriate pin to the ignition key switch as follows:
Active high (default): Connect pin 5 to Ground. Connect pin 8 to “high”

(10.5-32 V DC) when the ignition is on.

Active low: Connect pin 8 to positive DC voltage (10.5-32 V DC). Connect pin 5 to Ground (< 1.2 V DC) when the ignition is on.

- **Pin 6: Ground.**
(Non-configurable)
Pin 6 can be used as an external connection to ground. Pin 6 is connected to Ground in the terminal.
- **Pin 7: DC output.**
(Non-configurable)
Pin 7 can be used as a DC output. The voltage on pin 7 is 9-15 V and the output can supply up to 50 mA. Pin 7 can be used as power supply to a relay, ringer or similar.

For information on how to configure the I/O pins, see the user manual for the EXPLORER 727 system.

Starting up the system

5.1 Using the SIM card

5.1.1 Inserting the SIM card

The SIM card is provided by your Airtime Provider. Insert the SIM card as follows:

1. Open the SIM cover in the left side of the connector panel.

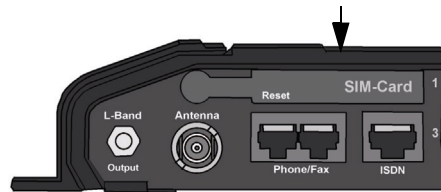

2. Insert the SIM card into the SIM slot.
Place the card with the chip side facing up as shown.

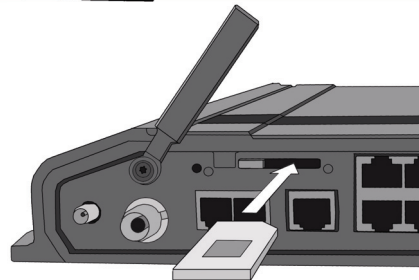

3. Press gently until it clicks.
4. Slide the lock in front of the SIM card.

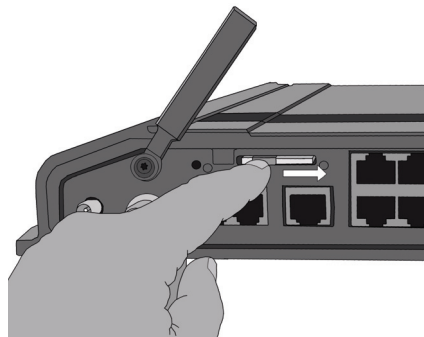

5. Close the cover for the SIM slot.

5.1.2 Removing the SIM card

Note

When the SIM card is removed, you cannot use the BGAN menu of the IP handset nor make calls or start data sessions. Only emergency calls are allowed, and only if permitted by the network.

However, if you have an administrator user name and password, you can upload software using the web interface without having a SIM card. For further information, see the user manual for the EXPLORER 727 system.

Remove the SIM card as follows:

1. Open the SIM cover in the left side of the connector panel.

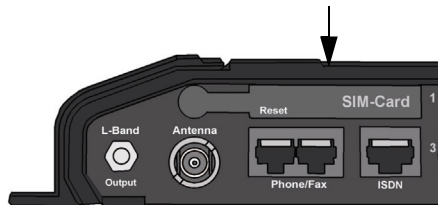

2. Slide the lock aside.

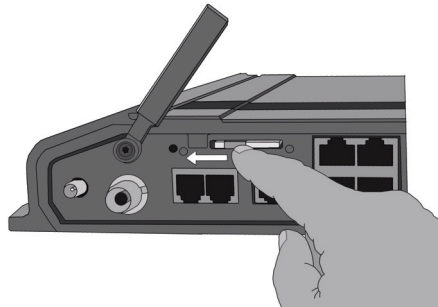

3. Gently push the SIM card and let it pop out.
4. Remove the SIM card and close the cover for the SIM slot.

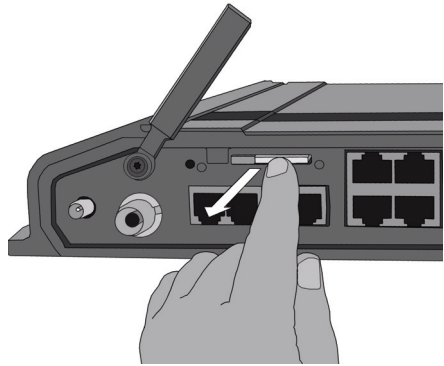

5.2 Powering the system

5.2.1 Switching the terminal on

Using the power switch

Note

If you have the 19" rack version of the EXPLORER 727 terminal, you can use the on/off switch in the front panel. See the next section *19" rack terminal: Using the front power switch*.

To switch on the terminal, use the On/Off switch in the connector panel. It normally takes one or two seconds for the terminal to switch on.

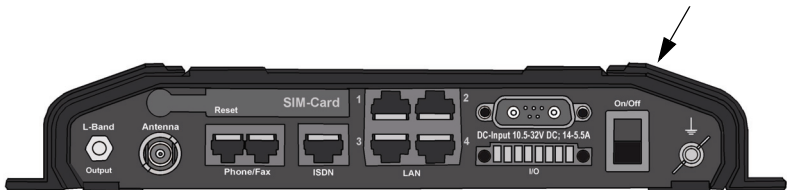

19" rack terminal: Using the front power switch

If you have the 19" rack version of the EXPLORER 727 terminal, tip the switch in the front panel to "1" to switch on the terminal.

It normally takes one or two seconds for the terminal to switch on.



Note

To be able to use the power switch on the front panel, you must leave the On/Off switch in the connector panel in the On position.

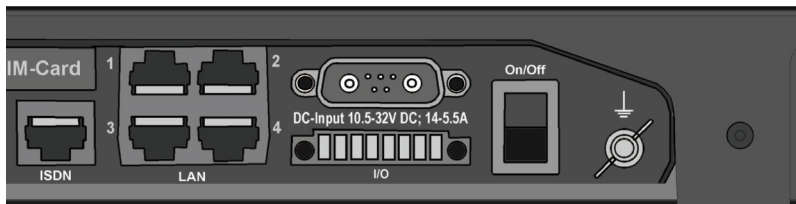

Must be On when front panel switch is used



Caution! When the system is powered on, stay clear of the antenna! The antenna emits radio frequency energy, **not only** when the system is used. Always keep a minimum distance of 1 m from the EXPLORER 727 antenna.

Using the ignition system

If you have connected the ignition system of your vehicle to the I/O connector, you may leave the power switch in the “on” position and the terminal will switch on/off when you start/stop the engine of your vehicle.

Note | If you have the 19” rack version of the terminal, you must leave both power switches in the “on” position to make use of the ignition function.

When the engine is stopped the terminal is in standby mode, meaning that only the primary parts of the system are kept alive. The standby current is max. 15 mA when the ignition is off. For information on how to connect to the ignition, refer to *Connecting to the ignition* on page 35.

You must set up the ignition function in the web interface. For further information, see the user manual for the EXPLORER 727 system.

Note | In some cases, the system may reboot after power-on because of the high start-up current.

Using a remote on/off switch

Note | In the 19” rack version of the terminal the remote on/off function is normally not available, because it is used for the front switch.

If an external switch is connected to the remote on/off pins in the DC connector, you may leave the power switch in the connector panel in the “on” position and use the remote switch to turn the terminal on and off. When the remote switch is off, the terminal is off. However, if you leave the power switch on the terminal in the “on” position, you can always switch the terminal back on with the remote switch. The standby current when the remote switch is off is max. 2 mA. For further information on how to connect a remote on/off switch, see *Connecting a Remote on/off switch* on page 36.

5.2.2 Switching the terminal off

To switch off the terminal, change the position of the power switch again.

Note

Wait at least 5 seconds after power off, before trying to power on the system again.

To switch off the 19" rack version of the terminal, set the power switch in the front to 0 and leave the On/Off switch in the connector panel in the position On.

To switch off using the Ignition function, leave the On/Off switch in the connector panel in the position On.

5.3 Entering the SIM PIN for the terminal

5.3.1 Overview

If your SIM card requires a PIN, you have to enter a PIN to use the system. You can enter the PIN using a standard or ISDN phone, the IP handset or the web interface.

For information on how to connect the handset or computer you are going to use, refer to the user manual.

5.3.2 Entering the PIN using a phone or IP handset

To enter the PIN

If you have a phone connected to the terminal, you can use it to enter the PIN at start up.

Do as follows:

- **For an analog or ISDN phone:**
Pick up the phone. When the terminal is waiting for a PIN, you will hear 2 beeps - pause - 2 beeps - etc.
Dial <PIN> followed by #.
When you hear a “busy” tone or a dialing tone, the PIN has been accepted and you can hang up or dial a number.
- **For an IP handset:**
Select the **BGAN** menu, select **ENTER PIN** and enter the user name and password for the terminal. Then enter the PIN for the terminal.

Note

The ENTER PIN menu item is only available if your SIM card requires a PIN, and the PIN has not yet been entered and accepted in the terminal.

Wrong PIN

Analog phone or ISDN phone:

If, instead of the busy tone or dialing tone, you continue to hear 2 beeps - pause - 2 beeps - etc., it means the PIN was not accepted. Check that you have the correct PIN and try again.

If a wrong PIN has been entered three times, you will hear 3 beeps - pause - 3 beeps - etc. This means you have to enter the PUK (PIN Unblocking Key) provided with your SIM card.

After entering the PUK, you must enter a new PIN of your own choice (4 to 8 digits long).

Dial the following:

<PUK> * <New PIN> * <New PIN> followed by # or off-hook key.

Example: If the PUK is 87654321 and the new PIN is 1234, dial **87654321 * 1234 * 1234** followed by # or off-hook key.

If you enter 10 wrong PUKs, the SIM card will no longer be functional. Contact your Airtime Provider for a new SIM card.

IP handset:

After having entered the user name and password for the terminal you have 3 attempts to enter the terminal PIN, before you are asked to enter the PUK (Pin Unblocking Key). The PUK is supplied with your terminal SIM card.

Enter the PUK followed by a new PIN of your own choice. The PIN must be from 4 to 8 digits long.

If you enter a wrong PUK 10 times, the SIM card will no longer be functional, and you have to contact your BGAN Airtime Provider for a new SIM card.

5.3.3 Entering the PIN using the web interface

If your SIM card requires a PIN and the PIN has not yet been entered when you start up the web interface, the start-up page will be the PIN page. Enter the PIN and click **OK**.

For further information on web interface, see the user manual.

5.4 Operating the system

5.4.1 General use

The user manual for the EXPLORER 727 system describes general use of the system and goes through all the functions of the web interface. It also contains a brief description of how to use the Thrane IP Handset with the terminal.

5.4.2 User interfaces

Overview

The main user interfaces for operation of the system are

- the built-in web interface (using a connected computer)
- the Thrane IP Handset

Built-in web interface

The built-in web interface is used for easy configuration and daily use. You access the web interface from a computer connected to the terminal, using an Internet browser. No installation of software is needed.

An Administrator password is required to access advanced configuration of the system.

For further information on the web interface, refer to the user manual for the EXPLORER 727 system.

IP handset

Apart from the standard functions of an IP handset, the Thrane IP Handset contains a display menu for the EXPLORER 727 system. For further information on the Thrane IP Handset, refer to the user manual for the IP handset.

Troubleshooting

6.1 Reset button

6.1.1 How to access the Reset button

The terminal has a Reset button placed next to the SIM slot behind the SIM cover. The functions of this button is described in the next section.



To press the Reset button, use a pointed device.

6.1.2 Function of the Reset button

The Reset button on the terminal has the following functions:

Action	Function
With the terminal running, press the Reset button normally.	<p>The terminal IP address and IP netmask are temporarily set to the default value (default IP address: 192.168.0.1).</p> <p>With this function, even if the IP address has been changed and you do not remember the new IP address, you can still access the web interface and see your current configuration. The default value is not saved in the configuration, but is only valid until next reboot.</p>
With the terminal running, press and hold the Reset button for 30 seconds, until the Power indicator on the terminal is flashing orange.	The terminal restores factory settings and reboots the system.

Action	Function
<p>While the terminal is booting, press and hold the Reset button.</p>	<p>For service use only!</p> <p>The bootloader initiates software upload. This firmware upload procedure is only to be used if the other procedures fail due to missing or corrupted firmware.</p> <p>This setup uploads software to the terminal from a TFTP server via the LAN connection. The procedure is as follows:</p> <ol style="list-style-type: none"> 1. Activate or install a TFTP server on a PC. 2. Locate the correct software image (xxx.dl) for the terminal and place it in the TFTP server directory. 3. Rename the image to ttexp.dl. 4. Reconfigure the PC LAN interface to use the static address 192.168.0.2/255.255.255.0. 5. Power off the terminal. 6. Connect the PC LAN Interface to the terminal. 7. Press and hold down the Reset button. 8. Keep the Reset button pressed while powering on the terminal, and through the next step. 9. Monitor the TFTP server window. When the upload starts you can release the Reset button. 10. When the TFTP upload finishes the terminal boots up using the new image.

6.2 Status signaling

6.2.1 Overview

The EXPLORER 727 system uses event messages and light indicators to display the status of the system.

6.2.2 Light indicators

Overview

The terminal has a number of light indicators, placed in the LED panel of the terminal:

- a green/orange Power indicator,
- a green/red/orange Terminal indicator,
- a green/red/orange Antenna indicator,
- a green Message indicator and
- 3 LAN indicators for each LAN interface, showing Activity (Green), Link/Speed (Green/Yellow) and PoE (Green/Red).

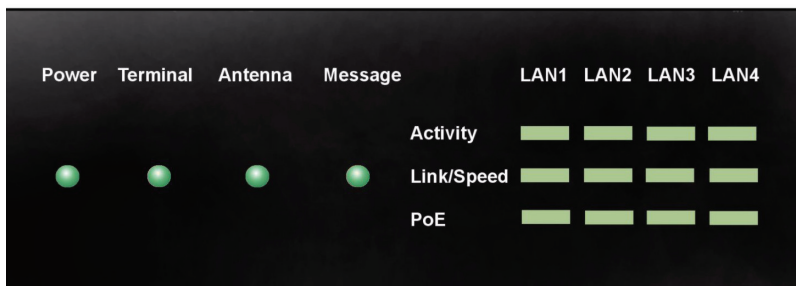

General status indicator functions

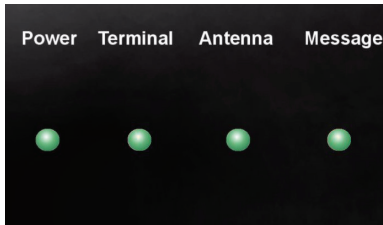

Power indicator

Behavior	Meaning
Steady green	Power OK.
Flashing green	The terminal is powering up.
Flashing orange	The terminal is closing down.
Off	No power.

Terminal indicator

Behavior	Meaning
Steady green	Ready. BGAN registration completed.
Flashing green	Please wait - process in progress. BGAN registration ongoing.
Orange	Warning - temporary malfunction. User action is required.

Behavior	Meaning
Red	Critical error. Check the event log. If the problem is in the EXPLORER 727 system and you cannot solve it, contact your distributor and return the unit for repair if necessary.

Antenna indicator

Behavior	Meaning
Steady green	Tracking. The antenna is ready for use.
Flashing green	Please wait - process in progress. Slow flashing: The antenna is starting up Rapid flashing: Sky scan
Orange	Warning - temporary malfunction. User action is required.
Red	Critical error. Check the event log in the web interface. If the problem is in the EXPLORER 727 system and you cannot solve it, contact your distributor and return the unit for repair if necessary.

Message indicator

Behavior	Meaning
Flashing green	A new SMS message has arrived.
Off	No new messages, or the unit is off.

LAN indicator functions

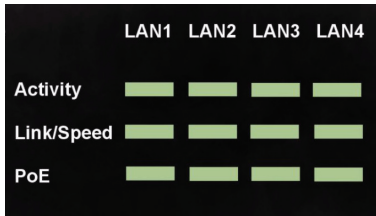

Activity indicator

Behavior	Meaning
Flashing green	The LAN port is active.

Link/Speed indicator

Behavior	Meaning
Green	Link speed is 100 Mbps.
Yellow	Link speed is 10 Mbps.
Off	The link is down.

PoE indicator

Behavior	Meaning
Green	The terminal is supplying power to the LAN port.
Red	The connected device requires more power than the terminal can supply to the LAN port.
Off	The terminal is not supplying power to the port.

6.2.3 Event messages

Display of event messages

The terminal can detect events during

- **POST** (Power On Self Test)
 - a self test performed at every power-up,
- **PAST** (Person Activated Self Test)
 - a self test performed when you click the **Self test** button under **Help desk** in the web interface, or
- **CM** (Continuous Monitoring)
 - continuous monitoring while the system is in operation.

When the terminal detects an event that requires your action, it issues an event message.

When your terminal issues an event message, the Terminal indicator or the Antenna indicator in the LED panel on top of the terminal signals the event, according to the tables *Terminal indicator* and *Antenna indicator* in the previous section.

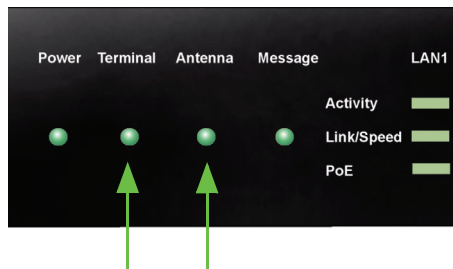

You can see the active event messages in the web interface by clicking the warning symbol in the icon bar at the top in the web interface.

All events are logged in the event log. For information on the event log, see *Event log* on page 69.

6.3 Logging of events

6.3.1 Diagnostic report

When contacting Thrane & Thrane A/S for support, please include a diagnostic report. The diagnostic report contains information relevant for the service personnel during troubleshooting.

To generate the diagnostic report, access the web interface and select **Help Desk**. Then click **Generate report**.

6.3.2 Event log

The event log holds information of all registered events in the terminal or antenna that are also shown in the Antenna and Terminal LEDs on the terminal.

The log includes the time of the occurrence, a short description, location of the error etc. This information can help troubleshooting errors in the system. You can see the event log in the web interface. For further information on the web interface, see the user manual for the EXPLORER 727 systems.

Part numbers

A.1 System units

A.1.1 TT-3722A EXPLORER[®] 727 system

Item	Part number
EXPLORER 727 antenna	403053B
EXPLORER 727 terminal or EXPLORER 727 19" Rack Terminal	403736A 403736A-T19

A.1.2 TT-3670A Thrane IP Handset & Cradle, wired

Item	Part number
Thrane IP Handset, wired	403672A
Thrane IP Cradle, wired	403674A

A.2 Spare parts

For information on available spare parts, log on to the Thrane & Thrane Extranet and enter the eShop at:

<http://shop.thrane.com>

Technical specifications

B.1 Overview

This chapter contains specifications for the EXPLORER 727 system including the terminal and antenna.

Note

For specifications and outline drawings for the Thrane IP Handset, refer to the manual for the IP handset.

B.2 Antenna

B.2.1 General specifications

Item	Specification
Type	BGAN Class 10, land-vehicular mechanical tracking antenna
Polarization	RHCP
Rx Freq. Band	1525.0 - 1559.0 MHz
Tx Freq. Band	1626.5 - 1660.5 MHz
GPS	1575.42 MHz
Channel Spacing	1.25 kHz
Antenna element	Gain (RX-band, min.): 12.7 dBi Gain (TX-band, min.): 13.26 dBi
G/T	$G/T \geq -12.5$ dBK
EIRP	Min. EIRP: 8 dBW Max. EIRP: 18 dBW
Return loss	Better than -10 dB/50 Ω

Item	Specification
Cable losses	RF attenuation: at 1660 MHz: max. 20 dB at 54 MHz: max. 4 dB at 36 MHz: max. 3 dB DC resistance (loop): max. 0.6 Ω Max. cable length between terminal and antenna: <ul style="list-style-type: none"> • RG-223_U-01: 14 meter • RG-214_U-01: 50 meter • S-07262-BD: 70 meter • S-10162-B-11: 92 meter
Antenna power supply	23.0 - 30.0 V DC, 47 W max. continuous (without cable loss). Measured at ATB input.
Total antenna weight	6 kg

B.2.2 Environmental specifications

Item	Specification
Water and dust	IP-56 dust and water jet proof.
Ambient Temperature	Operational: -25° to +55°C Storage: -40° to +80°C
Operating humidity	100%, condensing
Rain	Up to 100 mm/h, 0.5-4.5 droplets at 200 km/h

Item	Specification
Ice, survival	Up to 25 mm of ice (non-operational)
Wind	Normal operation with relative average wind velocity up to 200 km/h (56 m/s, 108 knots).
Vibration, operational	Random spectrum 1.05 g rms x 3 axes: 5 to 20 Hz: 0.02 g ² /Hz 20 to 150 Hz: -3 dB/octave
Vibration, non-operational	Random spectrum 1.7 g rms 2 h x 3 axes 6 h total): 5 to 20 Hz: 0.05 g ² /Hz 20 to 150 Hz: -3 dB/octave
Vehicle motion ^a	Turning rate: 60°/s Turning acceleration: 50°/s ² Induced acceleration: 0.5 g Velocity: Max. 200 km/h see note below!
Shock	Half sine, 20 g/11 ms
Solar radiation	1120 W/m ² according to MIL-STD-810F 505.4
Air Pressure, transport	4572 m AMSL MIL-SPEC 810E 500.4

- a. Note that these specifications only apply for the antenna alone. The values will differ depending on the mounting method. Especially when the antenna is mounted with brackets or magnetic mount the max. velocity is lower.

B.2.3 Antenna outline dimensions

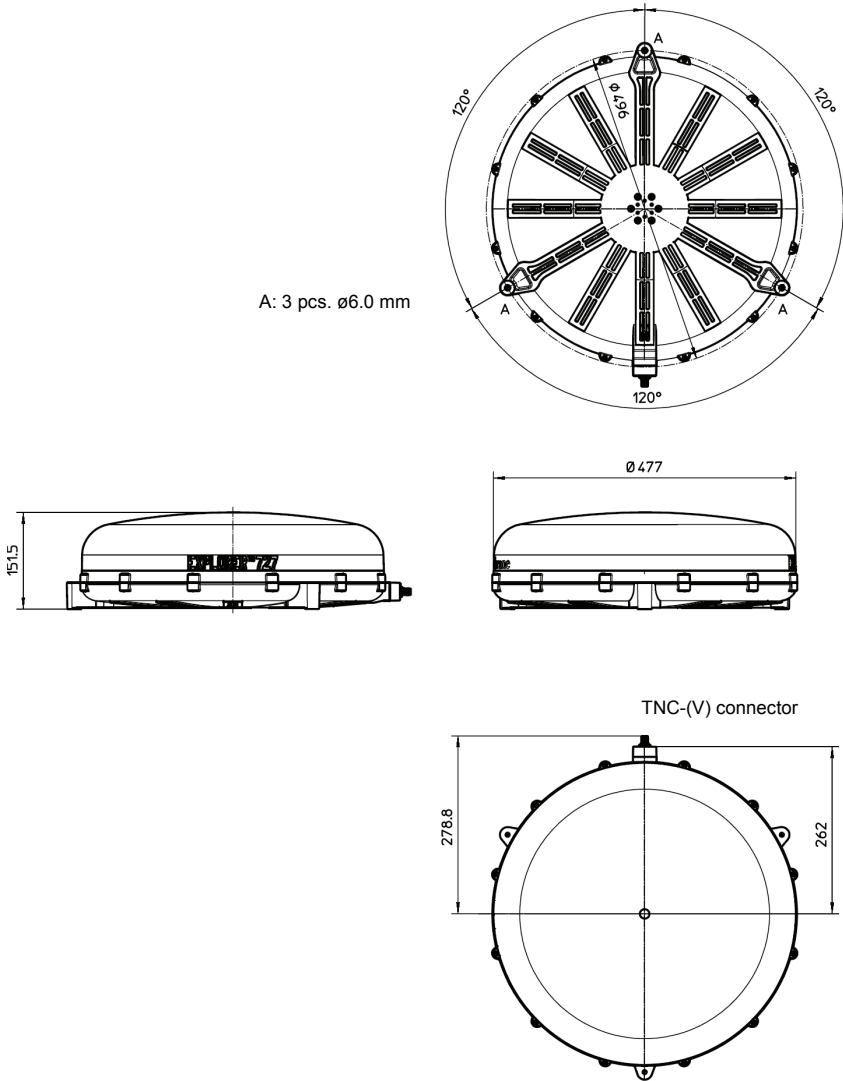

B.3 Terminal

B.3.1 General specifications (including 19” rack version)

Item	Specification
Weight	EXPLORER 727 terminal: 2.5 kg (5.5 lbs) EXPLORER 727 19” Rack Terminal: 5 kg (11 lbs)
Dimensions	EXPLORER 727 terminal: 264.5 mm x 273 mm x 42.5 mm (10.4” x 10.7” x 1.7”) EXPLORER 727 19” Rack Terminal: 342.3 mm x 482.6 mm x 43.65 mm (13.5” x 19” x 1.7”)
Global services Voice Data Standard IP Streaming IP SMS	4 kbps AMBE+2 or 3.1 KHz Audio 64 kbps UDI 432/432 kbps 32, 64, 128, 256 kbps Up to 160 characters
Antenna interface	One connector, TNC-female 1525 to 1559 MHz: -94 dBm to -64 dBm 1626.5 to 1660.5 MHz: -9 dBm to +11 dBm Power supply: 23.0 - 30.0 V DC,

Item	Specification
2-wire telephone interface	Two connectors: RJ-11 female. 600 Ω ITU-T Rec. G. 473, standard DTMF telephone. Supported cable length: up to 100 meters.
ISDN interface	One connector: RJ-45 female. Conforms with CCITT I.430, ETSI ETS300012, ANSI T1.605.
LAN interface	Four connectors: RJ-45 female. Conforms with IEEE 802.3 af, 10/100 Mbps. Supported cable length: up to 100 m PoE (max. 15.4 W) on each port, Total PoE power: 64 W at 24 V operation, 32 W at 12 V.
I/O interface Output: Open switch hold-off voltage Open circuit resistance Closed switch voltage Input: Input resistance Voltage Voltage High Voltage Low	One connector with 5 configurable inputs/outputs. Open collector, Short circuit protected at 1.5 A and reverse polarization protected. max. 32 V min. 130 K Ω max. 1 V DC at 50 mA min. 130 K Ω Max. 32 V Min. 2.2 V Max. 1.2 V

Item	Specification
L-Band output	Not currently used One connector: SMA female. Rx output, 1525 - 1559 MHz: -105 dBm to -80 dBm
Power Input	Connector: Mixed D-Sub 7W2 Nominal 12/24 VDC (10.5 - 32 V DC; 14 A - 5.5 A) Max. source impedance: 85 mΩ at 12 V, 500 mΩ at 24 V Maximum 20 A at 24 V, 5 ms (start up)
Standby current	Ignition function, off: max. 15 mA Remote on/off in DC connector, off: max. 2 mA
Ambient temperature	Operational: -25° to +55°C Storage: -40° to +80°C
Relative Humidity	95% non-condensing at +40°C

Side view and top view, including Basic cable support.

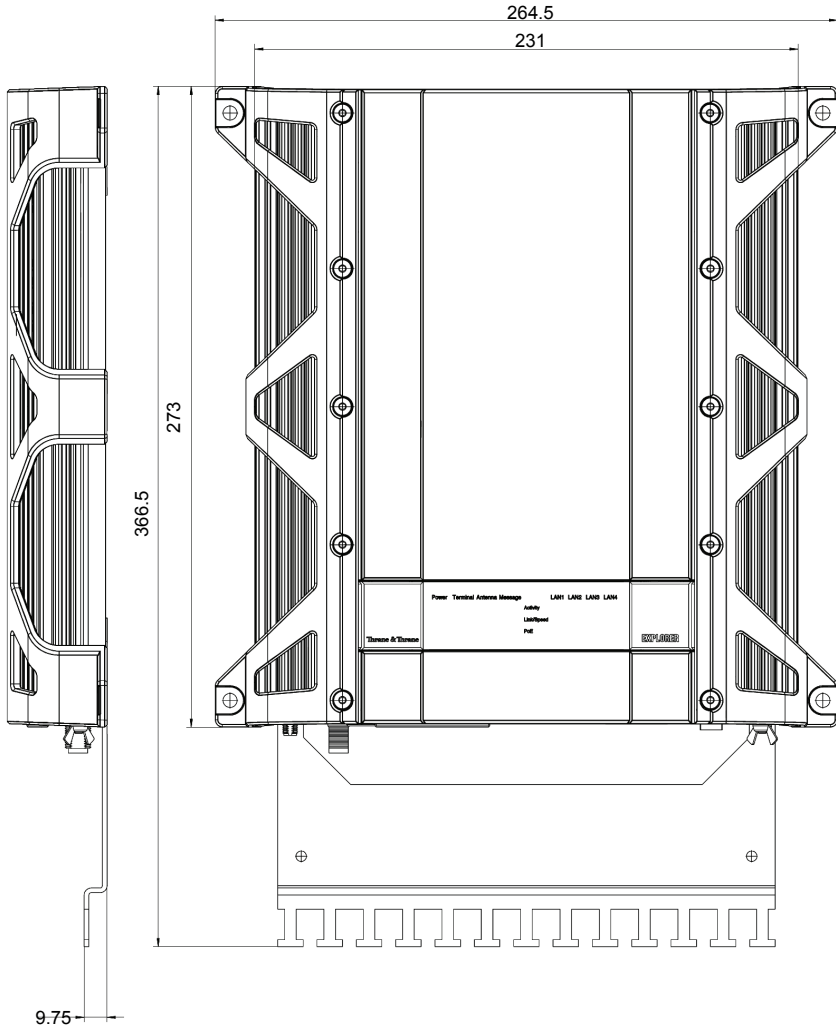

End view with serial number label and heat label.



Weight: 2.5 kg.

Dimensions are in mm.

B.3.3 Outline dimensions, EXPLORER 727 19" Rack Terminal

Front and top view, including Basic cable support.

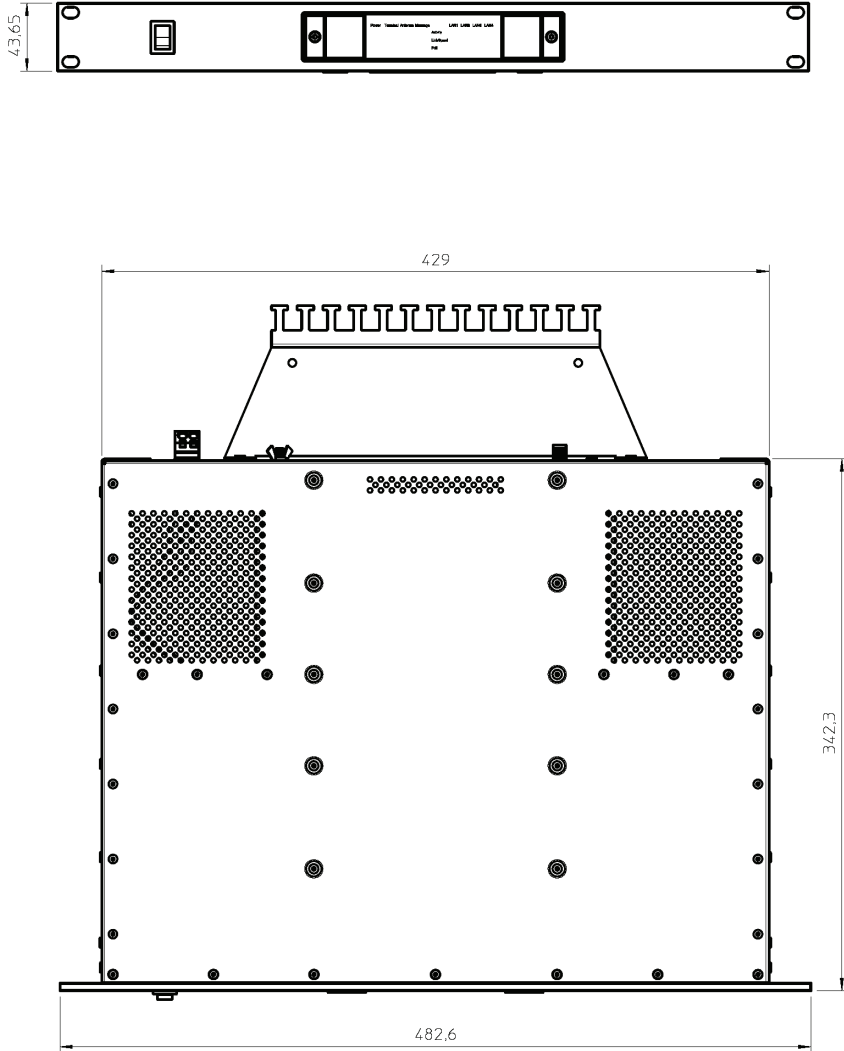

Connector panel, side view and perspective views, including Basic cable support.

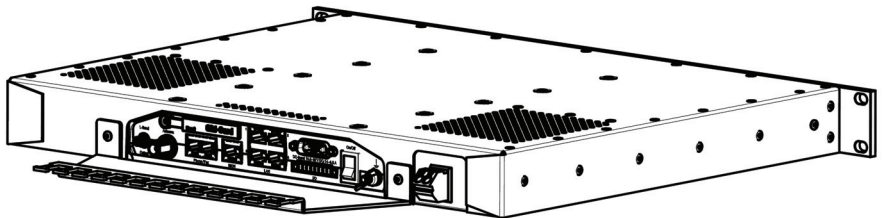
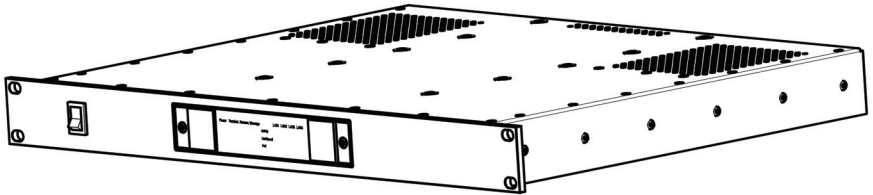
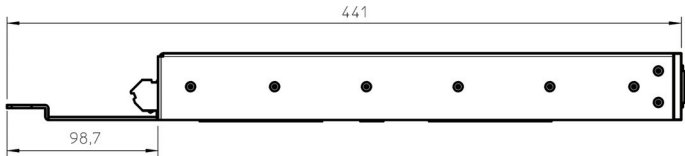

Weight: 5 kg.

Dimensions are in mm.

B.3.4 Measuring the source impedance

Select a power outlet from the 24 V DC or 12 V DC system, and measure the source impedance of the installation as described below.

1. Measure the voltage without load (R.var disconnected).
2. Set the current to e.g. 1 A by adjusting R.var.
3. Measure the corresponding voltage change.

Example: 1 A and 50 mV. Source impedance: $50 \text{ mV} / 1 \text{ Amp} = 50 \text{ m}\Omega$.

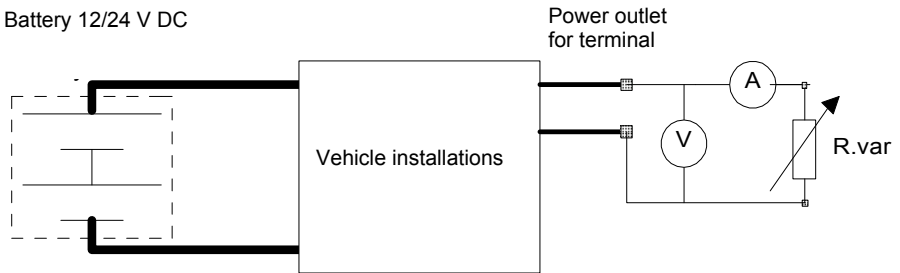

A

- AMSL** Above Mean Sea Level
- ATB** Antenna Tracking Board
- AWG** American Wire Gauge. A means of specifying wire diameters.

B

- BGAN** Broadband Global Area Network. A mobile satellite service that offers high-speed data up to 492 kbps and voice telephony. BGAN enables users to access e-mail, corporate networks and the Internet, transfer files and make telephone calls.

C

- CD** Compact Disc
- CM** Continuous Monitoring

D

- DC** Direct Current (or Continuous current). In direct current, the electric charges flow in the same direction, distinguishing it from alternating current (AC).
- DTMF** Dual Tone Multi Frequency. The keypad signaling technology that generates two distinct tones when each key is pressed. This system allows navigation of voice menus and other advanced calling services. All wireless phones use DTMF dialing.

E

EIRP Effective Isotropically-Radiated Power. The amount of power that would have to be emitted by an isotropic antenna (that evenly distributes power in all directions) to produce the peak power density observed in the direction of maximum antenna gain.

G

G/T A figure of merit of an antenna and low noise amplifier combination expressed in dB. "G" is the net gain of the system and "T" is the noise temperature of the system. The higher the number, the better the system.

GPIO General Purpose Input/Output

GPS Global Positioning System. A system of satellites, computers, and receivers that is able to determine the latitude and longitude of a receiver on Earth by calculating the time difference for signals from different satellites to reach the receiver.

I

I/O Input/Output

IMSO International Maritime Satellite Organisation. An intergovernmental body established to ensure that Inmarsat continues to meet its public service obligations, including obligations relating to the GMDSS.

IP Internet Protocol. The method or protocol by which data is sent from one computer to another on the Internet.

ISDN Integrated Services Digital Network. A circuit-switched telephone network system, designed to allow digital transmission of voice and data over ordinary telephone copper wires, resulting in higher quality and speed than are available with analog.

K

kbps kilobits per second

L

LAN Local Area Network

M

Mbps Megabit per second

P

PAST Person Activated Self Test. A test similar to the POST test, but activated by the user. The PAST causes the system to reset.

PC Personal Computer

PIN Personal Identification Number. A secret numeric password shared between a user and a system, used to authenticate the user to the system.

PoE Power over Ethernet. A standard for combining power supply with transmission of data over the Ethernet. The source unit "injects" power into the Ethernet cable and the power is "picked up" at the connected device.

POST Power On Self Test. A test sequence that runs every time the system is powered up or reset.

PUK Pin Unblocking Key

R

- RF** Radio Frequency. Electromagnetic wave frequencies between about 3 kilohertz and about 300 gigahertz including the frequencies used for communications signals (radio, television, cell-phone and satellite transmissions) or radar signals.
- RHCP** Right-Hand Circular Polarization.

S

- SIM** Subscriber Identity Module. The SIM provides secure storing of the key identifying a mobile phone service subscriber but also subscription information, preferences and storage of text messages.
- SMA** SubMiniature version A. A coaxial RF connector developed as a minimal connector interface for coaxial cable with a screw type coupling mechanism. The connector has a 50 Ohm impedance.
- SMS** Short Message Service

T

- TFTP** Trivial File Transfer Protocol. A very simple file transfer protocol, with the functionality of a very basic form of FTP. Since it is so simple, it is easy to implement in a very small amount of memory.
- TNC** Threaded Neill-Concelman. A type of RF connector used for terminating coaxial cables. The TNC connector is a threaded version of the BNC connector. The connector has a 50 Ohm

U

- UDI** Unrestricted Digital Information. A transparent 64 kbps data channel.

A

- alarms, 68
- analog phone/fax interface, 42
- antenna
 - cables, 9
 - clearance to base plane, 10, 15
 - dimensions, 77
 - drainage, 10
 - EXPLORER 727, 3
 - installation location, 8
 - installing, 9
 - interference, 8
 - magnetic mount, 15
 - maximum velocity, 76
 - obstructions, 8
 - outline, 77
 - radiation, 8
 - roof rail mount, 13

C

- cable support, 20, 23
- cables
 - antenna, 9
 - power, 28
- clearance
 - antenna to base plane, 10, 15
- condensation in antenna, 10

D

- delivery
 - items included, 7
- diagnostic report, 69

- dimensions
 - 19" rack terminal, 84
 - antenna, 77
 - terminal, 81
- discrete I/O interface, 47
- document number
 - this manual, i
- drainage of antenna, 10

E

- error messages, 68
- events
 - in LED panel, 68
 - logging, 69

H

- handset description, 4
- hardware interfaces, 37
- humidity in antenna, 10

I

- I/O interface, 47
- ignition function, 55
- ignition, connecting to, 35
- indicators, function, 64
- installation
 - antenna, 9
 - terminal, 20, 23

interfaces on terminal
 analog phone/fax interface, 42
 antenna, 38
 DC power input, 39
 discrete I/O, 47
 ISDN, 43
 LAN, 45
 overview, 37
 terminal block for front switch, 41
interference, 8
IP handset
 connecting, 46
 entering PIN with, 57
 short description, 4
ISDN interface, 43
items included in delivery, 7

L

LAN interface, 45
light indicators, function, 64

M

magnetic mount for antenna, 15
manual
 document number, i
measuring source impedance, 86
microwave radiation, iii

O

obstructions
 distance and size, 8
outline
 19" rack terminal, 84
 antenna, 77
 terminal, 81

P

part numbers, 71
Phone/Fax interface, 42
PIN
 entering in the web interface, 58
 entering with a phone, 57
 entering with IP handset, 57
pin-out
 analog phone/fax interface, 42
 antenna interface, 38
 DC power input, 40
 discrete I/O interface, 48
 ISDN interface, 44
 LAN interface, 46
placing the antenna, 8
placing the terminal, 18, 19
PoE, 45
power
 cable, 28
 cable extension, 31
 connecting, 33
 connecting remote on/off, 36
 sources, 27
 switching on, 53
 using remote on/off, 55
power input on terminal, 39
Power over Ethernet, 45
PUK code, 58

R

radiation level, iii, 8
remote on/off
 connecting, 36
 using, 55

reset button
 accessing, 61
 functions, 62
roof rail mount for antenna, 13

S

safety summary, iii
SIM card
 inserting, 51
 removing, 52
source impedance
 measuring, 86
spare parts, 71
specifications, 73
system units
 EXPLORER 727 antenna, 3
 IP handset, 4
 terminal, 1

T

technical specifications, 73
 antenna, 74
 terminal, 78
temperature, 18, 19
terminal
 cable support, 20, 23
 installation location, 18, 19
 installing, 20, 23
 introduction, 1
 outline and dimensions, 81, 84
tools for operation, 59
troubleshooting, 61
typography used in this manual, vii

U

user interfaces, 59

V

velocity, maximum for antenna, 76

TT-98-126844-C