

FM5500 User Manual V1.5



Table of contents

1	INTRODUCTION	6
1.1	ATTENTION	6
1.2	INSTRUCTIONS OF SAFETY	7
1.3	LEGAL NOTICE	7
1.4	ABOUT DOCUMENT	7
2	BASIC DESCRIPTION	8
2.1	PACKAGE CONTENTS	8
2.2	BASIC CHARACTERISTICS	8
2.3	MECHANICAL FEATURES	10
2.4	STICKERS OF FM5500 MODIFICATIONS	11
2.5	TECHNICAL INFORMATION ABOUT INTERNAL BATTERY	12
2.6	ELECTRICAL CHARACTERISTICS	12
2.7	ABSOLUTE MAXIMUM RATINGS	15
3	CONNECTION AND PINOUT.....	15
3.1	SIM CARDS INSERT SCHEME	15
3.2	INSTALLING FM5500 DRIVERS	17
3.3	NAVIGATE LED.....	18
3.4	STATUS LED	18
3.5	SOCKET 2×10 PINOUT	19
3.6	USB.....	20
4	FIRMWARE	21
4.1	UPDATING FIRMWARE USING USB CABLE	21
4.2	UPDATING FIRMWARE VIA GPRS	22
5	OPERATIONAL BASICS.....	23
5.1	OPERATIONAL PRINCIPLES.....	23
5.2	OPERATIONAL MODES	23
5.3	ACCELEROMETER	23
5.4	VIRTUAL ODOMETER	24
5.5	VOICE FUNCTIONALITY	24
5.6	PROFILES.....	25
5.7	FEATURES.....	25
	<i>Scenarios.....</i>	<i>25</i>
	<i>Trip.....</i>	<i>26</i>
	<i>Geofencing.....</i>	<i>26</i>
	<i>iButton list</i>	<i>26</i>
6	CONFIGURATOR.....	26
6.1	STARTUP.....	26
6.2	CONFIGURATOR STRUCTURE.....	27
	<i>Buttons area</i>	<i>28</i>
	<i>Information area.....</i>	<i>29</i>
	<i>Profiles/global parameters selection area.....</i>	<i>29</i>
6.3	PARAMETERS CONFIGURATION	30
	<i>Global parameters Settings</i>	<i>30</i>
	<i>Settings and configurable parameters menu</i>	<i>31</i>
	6.3.1.1 System Settings.....	31
	6.3.1.2 GSM Settings.....	32
	6.3.1.2.1 GPRS	32
	6.3.1.2.2 SMS.....	32
	6.3.1.2.3 Operator List.....	33
	6.3.1.3 Features	35
	6.3.1.3.1 Mode	35

6.3.1.3.2	Scenarios	37
6.3.1.3.3	Trip	37
6.3.1.3.4	Geofencing	38
6.3.1.3.4.1	Geofencing settings.....	38
6.3.1.3.4.2	AutoGeofencing settings.....	39
6.3.1.3.5	iButton List	40
6.3.1.4	I/O.....	41
6.3.1.4.1	FM5500 available I/O list.....	41
6.3.1.4.2	I/O configuring.....	43
6.3.1.4.3	I/O properties	45
6.3.1.5	CAN	47
6.3.1.5.1	CAN interface parameters	47
6.3.1.6	Configurable parameter values and Global parameter values	49
6.3.1.6.1	Configurable parameters.....	49
6.3.1.6.2	Global parameters.....	52
6.4	READ RECORDS	53
7	DUAL SIM FUNCTIONALITY	60
	<i>Home Network</i>	62
	<i>SIM 1 Roaming</i>	63
	<i>SIM 2 Roaming</i>	64
	<i>Unknown Operator</i>	65
	<i>Dual SIM algorithm</i>	66
8	PROFILE SWITCHING IN 1 SIM OPERATION MODE	56
8.1	PROFILE SWITCHING DEPENDENCE ON GSM OPERATOR	56
8.2	PROFILE SWITCHING DEPENDENCE ON I/O EVENT	58
	<i>Example #1</i>	59
	<i>Example #2</i>	60
9	DATA ACQUISITION	69
9.1	GPS DATA ACQUISITION	69
	<i>Min. Period</i>	69
	<i>Min. Distance</i>	70
	<i>Min. Angle</i>	70
9.2	I/O DATA ACQUISITION	70
	<i>Configuration</i>	71
	<i>Event generation</i>	71
10	DEEP SLEEP MODE.....	72
11	FEATURES AND SCENARIOS	73
11.1	ECO DRIVING SCENARIO	73
	<i>Mounting Requirements</i>	74
	<i>Configuration</i>	76
	<i>Data output</i>	78
11.2	OVERSPEEDING SCENARIO	78
	<i>Mounting Requirements and Working Conditions</i>	78
	<i>Configuration</i>	78
11.3	IMMOBILIZER SCENARIO	79
	<i>Configuration</i>	79
11.4	AUTHORIZED DRIVING SCENARIO	79
	<i>Configuration</i>	79
11.5	COM1 AND COM2 WORKING MODES	79
	<i>Silent Mode</i>	79
	<i>FM Log Mode</i>	79
	<i>LLS Mode</i>	80
	11.5.1.1 LLS Mode Configuration.....	80
	11.5.1.2 LLS Polynoms Configuration	80
	<i>Multipacket support</i>	81

	LCD Mode Configuration	81
	RFID HID Mode Configuration	81
	RFID MF7 Mode Configuration	82
	Garmin Mode Configuration.....	82
	11.5.1.3 Settings	82
	11.5.1.4 Firmware Configuration.....	83
	COM TCP Link Mode	83
	TCP Link Mode (Binary).....	84
	NMEA Log Mode.....	84
12	SMS COMMAND LIST	85
12.1	GETSTATUS	86
12.2	GETWEEKTIME	86
12.3	GETOPS	87
12.4	READOPS#	87
12.5	GETNMEAINFO.....	87
12.6	GETCFGTIME	87
12.7	GETGPS	87
12.8	LOADPROFILE#	88
12.9	CPURESET	88
12.10	RESETALLPROF	88
12.11	GETVER	88
12.12	GETIO.....	88
12.13	GETINFO	89
12.14	DELETERECORDS.....	89
12.15	READIO #	89
12.16	SETDIGOUT ##### X Y Z W	89
12.17	GETPARAM #####	90
12.18	SETPARAM ##### #	90
12.19	FLUSH #,#,#,#,#,#	90
12.20	GETGNSS	91
12.21	SN X.....	91
12.22	BANLIST.....	91
12.23	CRASHLOG	91
12.24	BRAMINFO	92
12.25	SETSIMSLLOT.....	92
12.26	GETSIMSLLOT	92
13	CAN	93
13.1	GENERAL DESCRIPTION.....	93
13.2	CONFIGURATION.....	94
13.3	EXAMPLE.....	95
13.4	AUTOCAN DESCRIPTION	98
	Configuration.....	99
	CAN monitoring	100
	Offline configuration.....	101
	AutoCAN ID list	102
14	RS485 INTERFACE	105
14.1	RS485 MODES.....	105
	RS485 Sleep mode	Error! Bookmark not defined.
	RS485 Receive (Silent) Mode	105
	RS485 Receive (TCP Link) Mode.....	106
	RS485 Receive (LLS) Mode	106
	RS485 Transmit (FM Log) Mode	106
	RS485 Transmit (GPS Nmea) Mode	107
	RS485 Self-Test Mode	107
14.2	RS485 INTERFACE	107

15	RFID	109
16	GARMIN	110
16.1	SUPPORTED GARMIN FMI PROTOCOLS	111
	<i>Standard protocols</i>	111
	<i>Enhanced protocols</i>	112
16.2	SUPPORTED FEATURES ON TAVL CLIENT APPLICATION	112
16.3	TEXT MESSAGING	112
16.4	DESTINATION MESSAGE	112
16.5	ETA REQUEST MESSAGE	113
16.6	CONNECTION AND PINOUT	113
17	LLS SENSOR	114
17.1	SPECIFICATIONS	115
17.2	HARDWARE	115
17.3	CONNECTING LLS TO FM5500	115
18	GPRS COMMANDS	123
19	DEBUG MODE.....	126
20	CHANGE LOG	127

1 INTRODUCTION

1.1 Attention



Do not disassemble the device. If the device is damaged, the power supply cables are not isolated or the isolation is damaged, before unplugging the power supply, do not touch the device.



All wireless data transferring devices produce interference that may affect other devices which are placed nearby.



The device must be connected only by qualified personnel.



The device must be firmly fastened in the predefined location.



The programming must be performed using a second class PC (with autonomic power supply).



The device is susceptible to water and humidity.



Any installation and/or handling during a lightning storm are prohibited.



FM5500 has USB interface;
Please use cables provided with FM5500 device.
JCS Teltonika is not responsible for any harm caused by using wrong cables for PC <-> FM5500 connection.



This sign on the packaging means that the electric and electronic equipment to be utilized must be stored separately.

1.2 Instructions of safety

This chapter contains information on how to operate FM5500 safely. By following these requirements and recommendations, you will avoid dangerous situations. You must read these instructions carefully and follow them strictly before operating the device!

To avoid mechanical damage, it is advised to transport the FM5500 device in an impact-proof package. Before usage, the device should be placed so that its LED indicators are visible, which show the status of operation the device is in.

When connecting the connection (2x10) cables to the vehicle, the appropriate jumpers of the power supply of the vehicle should be disconnected.

Before dismounting the device from the vehicle, the 2x10 connection must be disconnected.

The device is designed to be mounted in a zone of limited access, which is inaccessible for the operator. All related devices must meet the requirements of standard EN 60950-1.

The device FM5500 is not designed as a navigational device for boats.

1.3 Legal Notice

Copyright © 2012 Teltonika. All rights reserved. Reproduction, transfer, distribution or storage of part or all of the contents in this document in any form without the prior written permission of Teltonika is prohibited.

Garmin and the Garmin logo are registered trademarks, all rights reserved.

Other products and company names mentioned here may be trademarks or trade names of their respective owners.

1.4 About document

This document contains information about the architecture, possibilities, mechanical characteristics, and configuration of the FM5500 device.

Acronyms and terms used in document:

PC – Personal Computer

GPRS – General Packet Radio Service

GPS – Global Positioning System

GSM – Global System for Mobile Communications

SMS – Short Message Service

AC/DC – Alternating Current/Direct Current

I/O – Input/Output.

Record – AVL data stored in FM5500 memory. AVL data contains GPS and I/O information

AVL packet - Data packet that is being sent to server during data transmission. AVL packet contains from 1 to 50 records.

Geofence – a virtual geographic area of interest that can be defined by a radius or polygon for the location. In this document term “Geofence” is often used as functionality, which generates an event when crossing a defined area.

2 BASIC DESCRIPTION

FM5500 is a terminal with GPS and GSM/GPRS connectivity, which is able to determine the object's coordinates and transfer them via the GSM/GPRS network. This device is perfectly suitable for applications, which need location acquirement of remote objects. It is important to mention that FM5500 has additional inputs and outputs, which let you control and monitor other devices on remote objects. FM5500 also has a USB port for device status log output and entering configurations.

2.1 Package contents¹

Usually the FM5500 device sample is supplied to the customer in a cardboard box containing all the equipment that is necessary for operation. The package contains:

- FM5500 device
- Input and output power supply cable with 2x10 connection pins
- 4 screws for assembling device
- GPS/GLONASS antenna
- GSM antenna
- USB cable
- Port 1/2 cable
- Port 3 cable
- Card with link to drivers and configurator

2.2 Basic characteristics

GSM/GPRS features:

- Teltonika TM11Q quad band module (GSM 850 / 900 / 1800 / 1900 MHz);
- GPRS class 10;
- SMS (text, data).

GPS features:

- Ublox NEO-6M 50 channel GPS receiver;
- Protocol NMEA-0183: GGA, GGL, GSA, GSV, RMC, VTG;
- Up to -160 dBm sensitivity.

GNSS GGG303 Module features:

- Navigation Systems; GPS/GLONASS/GALILEO/QZSS;
- Protocol NMEA-0183: GGA, GGL, GSA, GSV, RMC, VTG;
- Up to -162 dBm sensitivity.

¹ Package content depends on Order Code, and can be customized by customer needs.

Hardware features:

- Cortex®-M3 processor;
- 16 MB internal Flash memory;
- Built-in accelerometer.
- Internal backup battery included

Power supply features:

- Power supply: 10 ÷ 30V;
- Protection against reverse polarity using a fuse according to ISO 16750-2 (2010) (fuse blows if polarity is reversed);
- Immunity to an impulse voltage influence via power supply is compliant to:
 - ISO 7637-2 (2011): Test pulse 1, 2a and 2B, 3a and 3b for the 12V and 24V power systems;
 - ISO 16750-2 (2010): Test pulse 4 for the 12V and 24V power systems at the first level of strict conditions; Test “Load Dump” for the 12V systems ($U_s=101V$, $t_d=0,4s$, $R_i=40\Omega$) and for the 24V system ($U_s=202V$, $t_d=0,35s$, $R_i=80\Omega$)

Interface features:

- USB port;
- 4 digital inputs;
- 4 analog inputs;
- 4 open collector digital outputs;
- 1Wire® temperature sensor;
- 1Wire® iButton;
- LEDs indicating device status;
- 2xRS232 ports;
- Audio interface;
- CAN messages 2.0 A, B Active support. Speed up to 1 Mbit/s.

Functionality features:

- Configurable record length 256 Bytes/64 Bytes gives opportunity to save up to 47,615/150,000 records (refer to chapter 6.4);
- Roaming enabling/disabling;
- Offline working mode;
- Records importing using USB;
- Remote logs reading via SMS/GPRS;
- RS485 interface;
- DUAL SIM switching mode (refer to chapter 7).

FM5500 versions:

- GPS only modification;
- GPS/GLONASS modification.

2.3 Mechanical features

Table 1 FM5500 physical interfaces and operation environment

Part name	Physical specification	Operation environment
Navigation LED	LED	Operation temperature: -25°C ... +55°C Storage temperature: -40°C ... +70°C Storage relative humidity 5 ... 95 % (non condensating)
Modem LED	LED	
GPS	GPS antenna connector MCX	
GSM	GSM antenna connector SMA female outer shell, female inner pin	
Socket 2x10	Tyco Micro MATE-N-LOK™ or similar	
USB	Mini USB socket	
Port1	RS232 port channel 1 (RJ45 socket)	
Port2	RS232 port channel 1 (RJ45 socket)	
Audio port	RJ11	

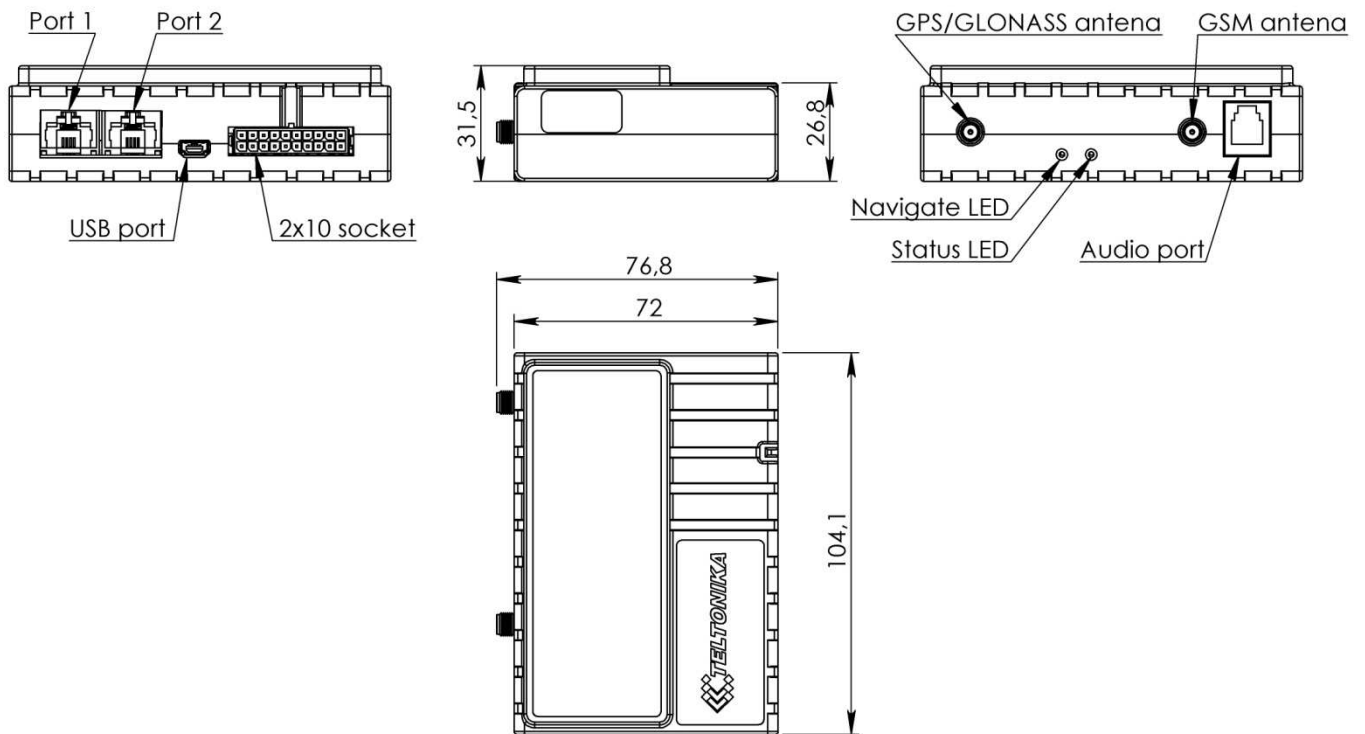

Figure 1 FM5500 view & dimensions in mm (tolerance ± 2 mm)

2.4 Stickers of FM5500 modifications

FM5500 has two modifications: GPS/GLONASS and GPS. Figure 2 refers to GPS/GLONASS modification and Figure 3 refers to GPS modification of FM5500.

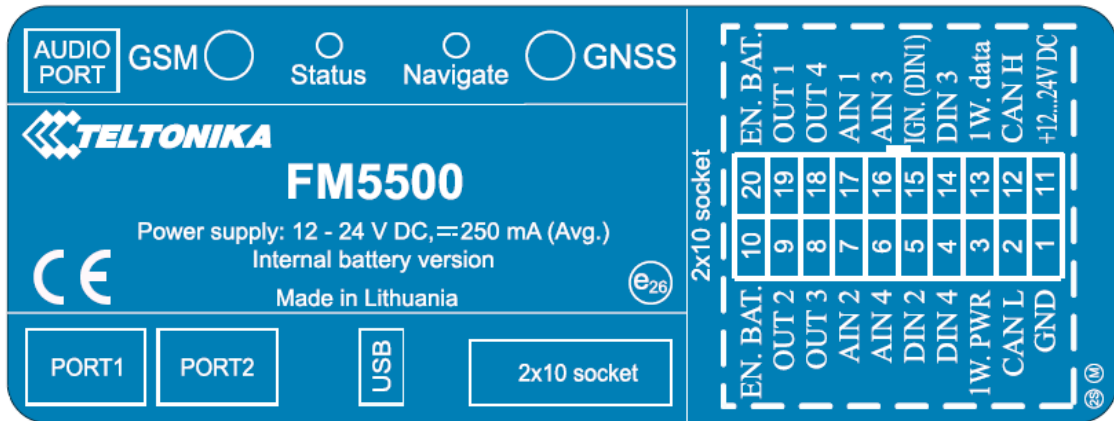

Figure 2 FM5500 sticker for GPS/GLONASS modification

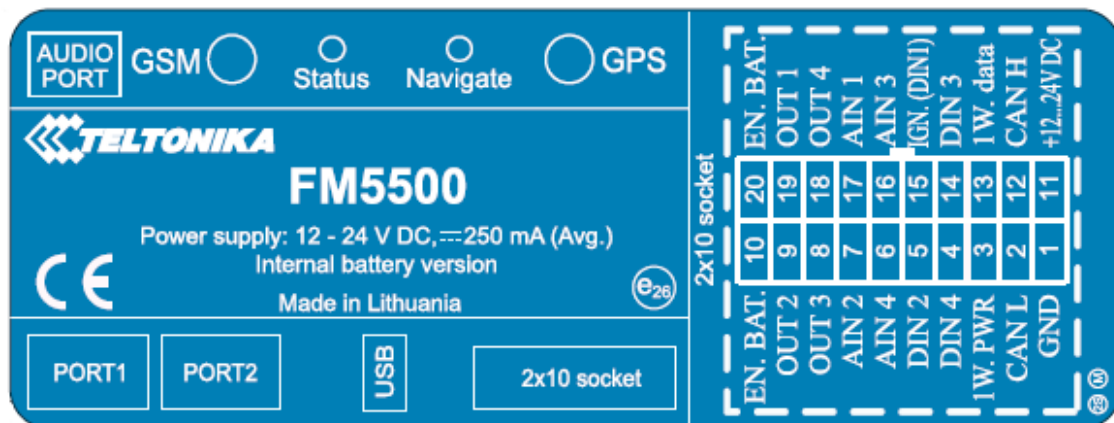

Figure 3 FM5500 sticker for only GPS modification

2.5 Technical Information about internal battery

Ni-MH Rechargeable battery, 8.4V, 550 mA.

FM5500 operating time with internal backup battery depends on temperature, data sending frequency (SMS and GPRS), and accumulator age, number of charge/discharge cycles.

For example:

- In sleep mode a new FM5500 device, operating time approximately 15 hours
- In deep sleep mode – 137 hours
- Operating time for a new FM5500 device, working in normal mode (records are being acquired every 10 sec. and sent in packets of 4 records every 60 sec.), is approximately 2 h 30 min.

2.6 Electrical characteristics

Table 2 Electrical characteristics

CHARACTERISTIC DESCRIPTION	VALUE			
	Min.	Typ.	Max.	Unit
SUPPLY VOLTAGE				
Supply Voltage (Recommended Operating Conditions)	11.8	-	30	V
Supply Voltage (for internal rechargeable battery charging proper functioning)	9.5	-	30	V
POWER SUPPLY CURRENT (HARDWARE VERSION WITH INTERNAL BATTERY)				
Deep Sleep, average, I _{cc.ds}	-	1.5	4	mA
Sleep, average, I _{cc.ds} , V _{cc} =12V	-	35	-	mA
Sleep, average, I _{cc.ds} , V _{cc} =24V	-	20	-	mA
U _{cc} =12.6V, all modules fully working, internal battery is charging, I _{cc1}	-	-	315	mA
U _{cc} =12.6V, all modules fully working, internal battery is charged, I _{cc2}	-	-	245	mA
U _{cc} =25.2V, all modules fully working, internal battery is charging, I _{cc3}	-	-	158	mA
U _{cc} =25.2V, all modules fully working, internal battery is charged, I _{cc4}	-	-	123	mA
SUPPLY CURRENT (HARDWARE VERSION WITH EXTERNAL BATTERY)				
Deep Sleep, average, I _{cc.ds}	-	1.5	4	mA
U _{cc} =12.6V, all modules fully working, internal battery is charging, I _{cc5}	-	-	566	mA
U _{cc} =12.6V, all modules fully working, internal battery is charged, I _{cc6}	-	-	245	mA
U _{cc} =25.2V, all modules fully working, internal battery is charging, I _{cc7}	-	-	283	mA
U _{cc} =25.2V, all modules fully working, internal battery is charged, I _{cc8}	-	-	123	mA

CHARACTERISTIC DESCRIPTION	VALUE			
	Min.	Typ.	Max.	Unit
DIGITAL OUTPUT (OPEN DRAIN GRADE)				
Drain current (Digital Output OFF)	-	-	120	uA
Drain current (Digital Output ON, Recommended Operating Conditions)	-	-	300	mA
Static Drain-Source resistance (Digital Output ON)	-	-	300	mOhm
DIGITAL INPUTS				
Input resistance (DIN1, DIN2, DIN3)	15	-	-	kOhm
Input Voltage (Recommended Operating Conditions)	0	-	Supply voltage	V
Input Voltage threshold (DIN1)	-	7,5	-	V
Input Voltage threshold (DIN2, DIN3, DIN4)	-	2,5	-	V
ANALOG INPUTS				
Input Voltage (Recommended Operating Conditions), Range1	0	-	10	V
Input resistance, Range1	-	120	-	kOhm
Input Voltage (Recommended Operating Conditions) Range2	0	-	30	V
Input resistance, Range2	-	147	-	kOhm
OUTPUT SUPPLY VOLTAGE 1-WIRE²				
Supply Voltage	3,3	-	3,9	V
Output inner resistance	-	7	-	Ohm
Output current ($U_{out} > 3.0V$)	-	30	-	mA
Short circuit current ($U_{out} = 0$)	-	130	-	mA
CAN INTERFACE				
Internal terminal resistors CAN bus	-	No	-	Ohm
Differential input resistance	19	30	52	kOhm
Recessive output voltage	2	2.5	3	V
Differential receiver threshold Voltage	0.5	0.7	0.9	V
Common mode input voltage	-30	-	30	V

² 1-wire Supply voltage PIN is dedicated for 1-wire devices ONLY, do not use it for any other purpose.



When connecting a COM port to an active external device keep in mind that the first power supply must be connected to FM5500, and then the external device should be powered. Connecting external devices when FM5500 is powered off is not recommended.

2.7 Absolute Maximum Ratings

Table 3 Absolute maximum ratings

CHARACTERISTIC DESCRIPTION	VALUE	Min.	Typ.	Max.	Unit
Supply Voltage (Absolute Maximum Ratings)		-32		32	V
Digital output clamp threshold voltage (Absolute Maximum Ratings), ($I_{\text{drain}} = 2\text{mA}$)		36			V
Digital Input Voltage (Absolute Maximum Ratings)		-32		32	V
Analog Input Voltage (Absolute Maximum Ratings)		-32		32	V
Voltage on Supply Voltage 1-Wire (Absolute Maximum Ratings)		0		10	V
Voltage on Data Input/Output 1-Wire (Absolute Maximum Ratings)		0		10	V
Voltage on CANH, CANL (Absolute Maximum Ratings)		-58		58	V

3 CONNECTION AND PINOUT

3.1 SIM cards insert scheme

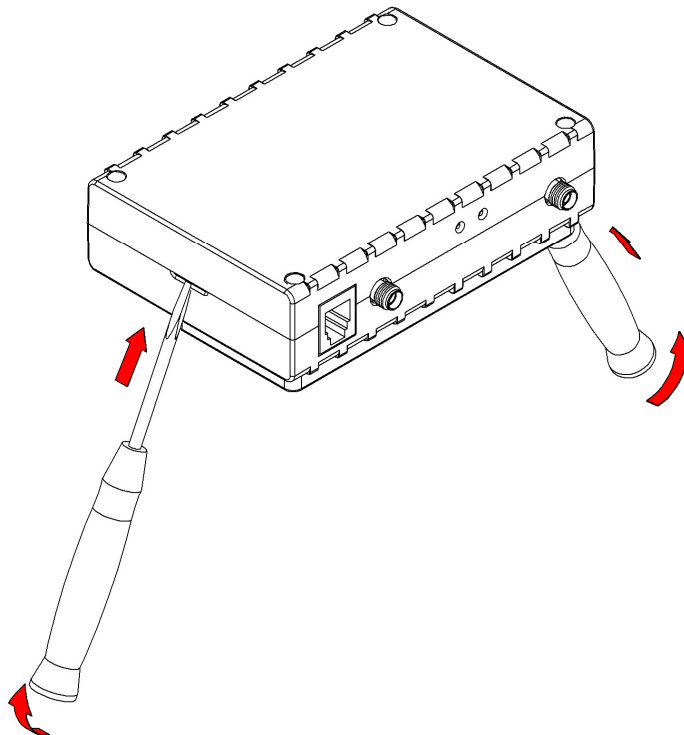

①

Gently open FM5500 case using screwdrivers

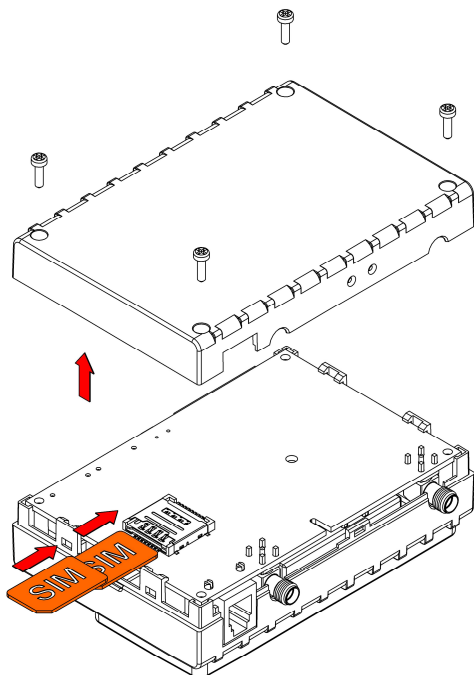

②

Take off FM5500 case and insert SIM cards as shown. **SIM SLOT 1 (default, recommended for 1 SIM mode) is closer to PCB, SIM SLOT 2 is the upper one**

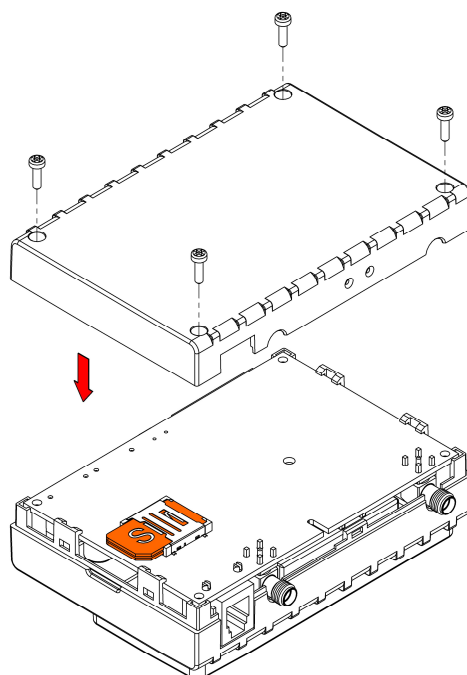

③

Assemble device as shown and put screws into the holes

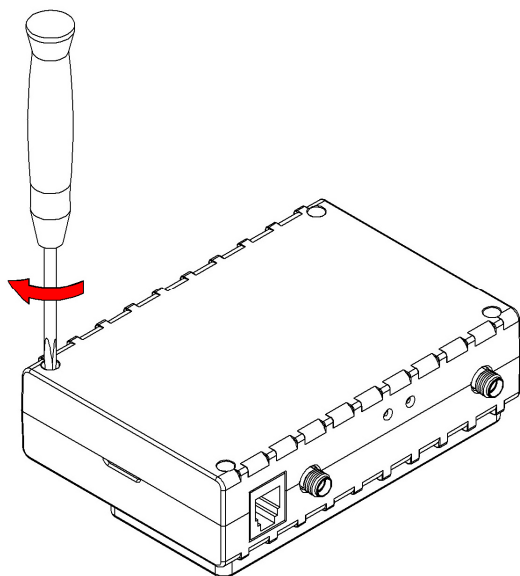

④

Screw all 4 screws

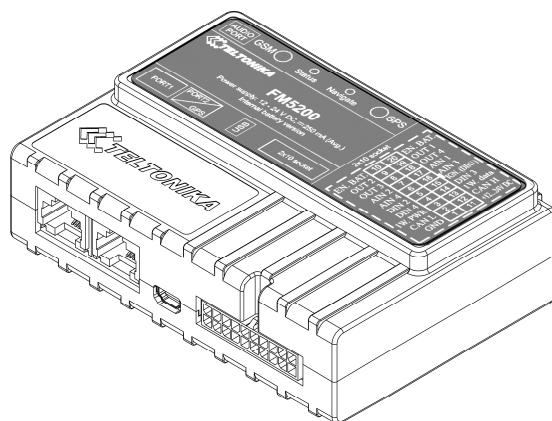

⑤

Device is ready

3.2 Installing FM5500 drivers

Software requirements

- Operating system 32-bit and 64-bit: Windows XP with SP3 or later, Windows Vista, Windows 7.
- MS .NET Framework V3.5 or later (<http://www.microsoft.com> or <http://av11.teltonika.lt/downloads/tav/Framework/dotnetfx35setupSP1.zip>).

Drivers

Please download Virtual COM Port drivers from Teltonika website: http://av11.teltonika.lt/downloads/FM11/vcpdriver_v1.3.1_setup.zip

Installing drivers

Extract and run VCPDriver_V1.3.1_Setup.exe. This driver is used to detect FM5500 device connected to the computer. Click 'Next' in driver installation window (figures below):

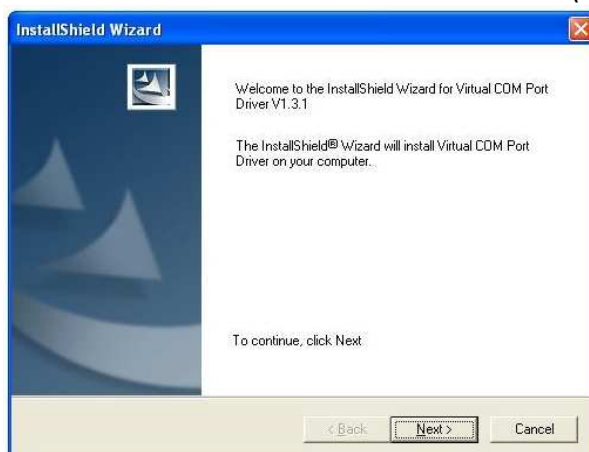

Figure 4 Driver installation window

This will launch the device driver installation wizard. In the following window click 'Next' button again:



Figure 5 Driver installation window

Setup will continue installing drivers and will display a window about successful process in the end. Click 'Finish' to complete setup:



Figure 6 Driver installation window

You have now installed drivers for FM5500 device successfully.

3.3 Navigate LED

Table 4 Navigate LED operation

Behaviour	Meaning
Permanently switched on	GPS signal is not received
Blinking every second	Normal mode, GPS is working
Off	GPS is turned off because: <ul style="list-style-type: none"> • Deep sleep mode Or <ul style="list-style-type: none"> • GPS antenna short circuited

3.4 Status LED

Table 5 Status LED Operation

Behaviour	Meaning
Blinking every second	Normal mode
Blinking every 2 seconds	Deep sleep mode
Blinking fast for a short time	Modem activity
Blinking fast constantly	Boot mode
Off	<ul style="list-style-type: none"> • Device is not working Or <ul style="list-style-type: none"> • Device firmware being flashed

3.5 Socket 2×10 pinout

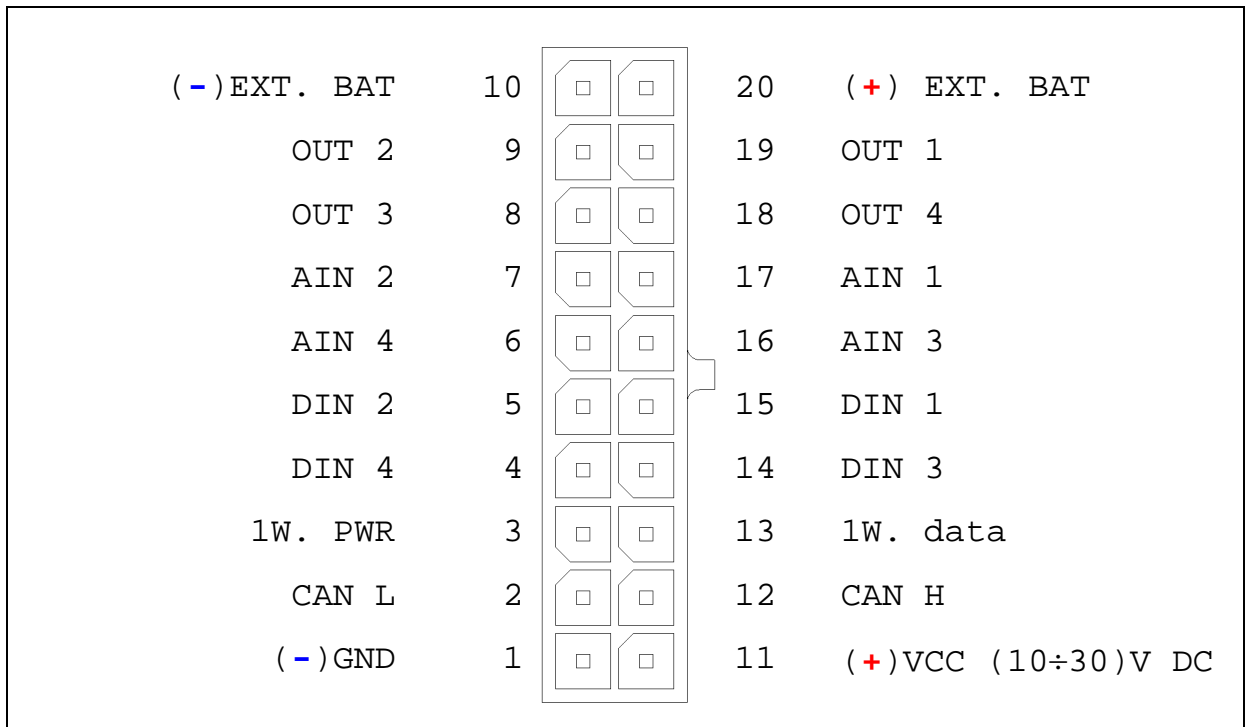

Figure 7 2x10 socket pinout

Table 6 2x10 SOCKET PINOUT DESCRIPTION

Pin Nr.	Pin Name	Description
1	(-)GND	(-) Ground pin. (10...30) V DC*
2	CAN L	SAE J1939 CAN interface Low channel
3	1W. PWR	Power supply pin for Dallas 1-Wire® devices
4	DIN 4	Digital input. Channel 4
5	DIN 2	Digital input. Channel 2
6	AIN 4	Analog input, channel 4. Input range: 0 - 30V DC
7	AIN 2	Analog input, channel 2. Input range: 0 - 30V/ 0 - 10V DC
8	OUT 3	Digital output. Channel 3. Open collector output
9	OUT 2	Digital output. Channel 2. Open collector output
10	Ext. Battery (-)	1. For FM5500 with internal battery this pin is connected with pin 20 (Ext. Battery (+)). When pin 10 and pin 20 are connected, the internal accumulator is on, while disconnected – the internal accumulator is off. For FM5500 with external battery this pin should be connected to (-) of the external battery.*
11	(+)VCC (10...30) V DC	Power supply pin
12	CAN H	SAE J1939 CAN interface High channel
13	1W. data	Data channel for Dallas 1-Wire® devices
14	DIN 3	Digital input, channel 3
15	DIN 1	Digital input, channel 1 (RESERVED FOR IGNITION LINE)

Pin Nr.	Pin Name	Description
16	AIN 3	Analog input, channel 3. Input range: 0 - 30V DC
17	AIN 1	Analog input, channel 1. Input range: 0 - 30V/ 0 - 10V DC
18	OUT 4	Digital output. Channel 4. Open collector output
19	OUT 1	Digital output. Channel 1. Open collector output
20	Ext. Battery (+)	<p>1. For FM5500 with internal battery this pin is connected with pin 10 (Ext. Battery (—)). When pin 10 and pin 20 are connected, the internal accumulator is on, while disconnected – the internal accumulator is off.</p> <p>For FM5500 with external battery this pin should be connected to (+) of the external battery.*</p>

3.6 USB

When FM5500 is connected to a PC it creates a STM Virtual COM Port, which can be used as a system port (to flash firmware and configure the device).

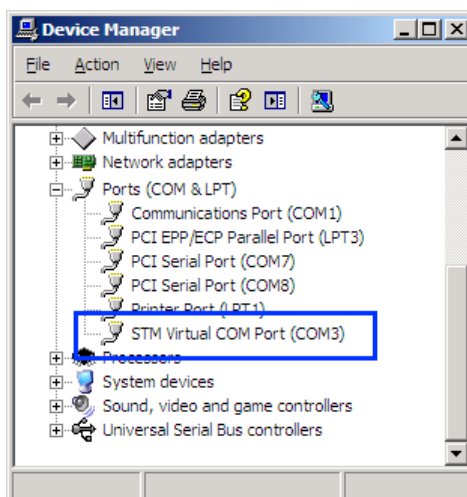

Figure 8 COM-Ports

* FM5500 with external battery is available as separate device. Do not try connecting any external batteries on a standard FM55 device.

Contact your sales manager for more details on the solution available.

4 FIRMWARE

4.1 Updating firmware using USB cable

FM5500 functionality is always improving, new firmware versions are developed. Current module firmware version can be retrieved from configurator. See configuration description for details.

Contact sales manager to get the latest firmware.

Updater is needed to update the firmware. It can be downloaded from:

<http://avl1.teltonika.it/downloads/FM55/>

Firmware must to be copied to “Firmware updater” folder.

Connect FM5500 to PC with USB cable. Launch “Firmware Updater”, select COM port, click connect and update. Update process may take up to several minutes.

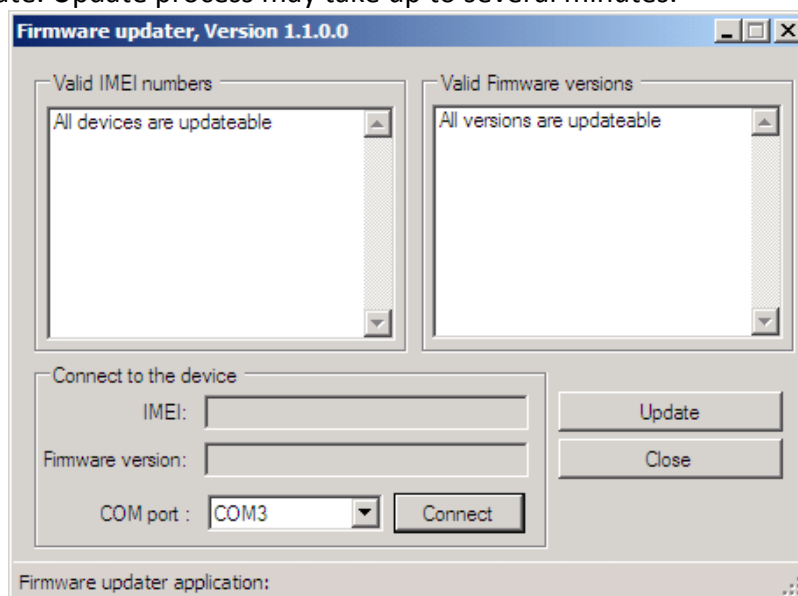

Figure 9 FM updater screen

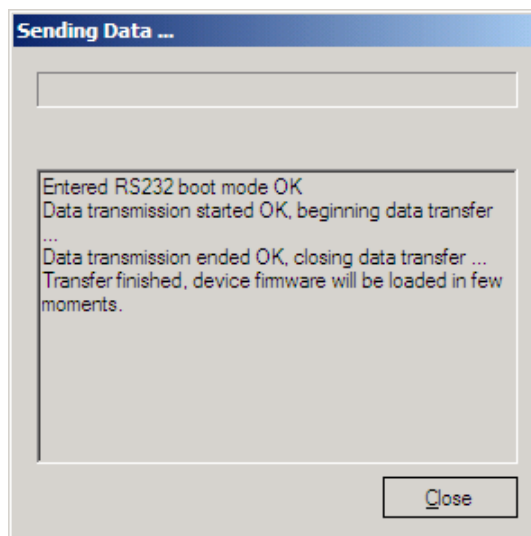

Figure 10 FM firmware updating finished

4.2 Updating firmware via GPRS

Firmware can also be updated over GPRS using RILS system.

RILS stands for Remote Imlet Loading System, which is used to update FM5500 processor firmware. In order to update firmware, server sends an SMS to the FM5500 and directs it to connect to the server and download new firmware. The special web interface is used for this operation. Address of the web application is: <http://212.47.99.62:5002/RILS-web/>.

For RILS login and password please contact your sales manager.

The screenshot shows the 'Remote Imlet Loading' web interface. At the top, there are navigation tabs: 'Upload N12', 'Upload Fm4', 'Monitor', and 'User'. The 'User' tab is active, showing 'User: demo' and a 'Logout' button. Below the navigation is the heading 'Step 2: Configure modules.' and a section for uploading modules from a file, with a 'Browse...' button and an 'Upload' button. The main configuration area is titled 'Please configure module (s)' and contains several input fields: 'IMEI:', 'Server IP address:', 'Server port:', 'Module number:', 'APN:', 'chap login', and 'chap password'. There is an 'Add module' button at the bottom right of this section and a 'Back' button at the bottom right of the entire interface.

Figure 11 Remote Configuration

After logging in click on 'Upload FM4', click Browse, select FM5500 firmware file from hard disk, click OK and then Upload. Select uploaded firmware from the list (last one) and click next. Enter necessary parameters in the fields:

1. Server IP: 212.47.99.62
2. Server port: 5009
3. Module number is GSM number of FM SIM in worldwide standard, for example: +37069912345.

Enter your APN, APN (chap) login and password. After entering all parameters, click 'Add Module'. To operate multiple devices, enter new IMEI and GSM number and click 'Add Module' again. Otherwise click 'Next' and if all data is correct, in next window click 'Upload'.

5 OPERATIONAL BASICS

5.1 Operational principles

FM5500 module is designed to acquire records and send them to server. Records contain GPS and I/O information. Module uses GPS receiver to acquire GPS data and is powered with 3 data acquire methods: time-based, distance-based and angle-based. Method's details are described in Data Acquisition chapter 9. All data is stored in flash memory and later can be sent via GPRS or SMS channels. GPRS mode is the most preferred data sending mode. SMS mode is mostly used in areas without GPRS coverage or when GPRS usage is too expensive.

GPRS and SMS settings are described in chapters 6.3.1.2.1 and 6.3.1.2.2. FM5500 communicates with server using special data protocol. Data protocol is described in "FMXXXX Protocols" document.

FM5500 can be managed by SMS commands (SMS Command list is described in SMS Command List section) and GPRS commands (GPRS Command list is described in GPRS Command List section). Module configuration can be performed over TCP or via SMS. Configuration parameters and modes are described in "FMXXXX Protocols" document.

5.2 Operational Modes

FM5500 is designed to operate in two different modes: Normal Mode, Sleep mode and Deep Sleep Mode (Standby mode). Normal Mode means that FM5500 is fully functional and performs all the functionality mentioned above in Operational principals section.

Deep Sleep Mode is designed to dramatically reduce power consumption. It is a separate mode and certain conditions must be fulfilled to switch from Normal operation and enter this mode. Detailed information about how FM5500 enters/exits Deep Sleep Mode and what functions does FM5500 perform while in this mode can be found in chapter 11.

5.3 Accelerometer

FM5500 has a built in 3 axis accelerometer which allows the device to indicate if vehicle is moving or not, as well as measure acceleration. Accelerometer sensitivity can be configured – it has 2 configurable global parameters: start and stop timeouts that define time intervals in seconds. To indicate that a vehicle is moving, FM5500 constantly (in frequency of 10 Hz) checks for g force change on X, Y and Z axes. If measured g force keeps exceeding the set limit (it is not configurable) for defined time interval in "Movement Filter Start" field (Figure 10), then the vehicle is considered as moving. Same settings for idle indication apply – if g force change is less than the set limit for time interval defined in "Movement Filter Stop" field then the vehicle is considered as idle (not moving).

Example for default parameters: Movement Filter Start = 1 and Movement Filter Stop = 30 means that movement will be detected after 1 second and stop will be detected after 30 seconds of inactivity.



Figure 12 Accelerometer settings

5.4 Virtual Odometer

Virtual odometer is used to calculate travelled distance in FM5500 as a separate I/O element. When FM5500 detects movement, it starts counting distance using GPS signal: every second it checks current location and calculates distance between current and previous point. It keeps adding these intervals until it is time to make a record, then FM5500 records its location and adds odometer value, which is equal to the sum of all distances, measured every second. When record is made, odometer resets to zero and distance calculation starts all over again.

If continuous odometer is enabled, then it is not resetting its value. It remembers last value and keeps counting giving total driven distance value. Start value can be set and driven distance will be counted from this value. It will further increase.

Virtual odometer as an I/O element can be also used with Trip feature, read chapter 6.3.1.3.3.

5.5 Voice Functionality

FM5500 has functionality to receive and make voice calls. To enable this functionality a telephone handset with electret microphone and RJ-11 connector must be connected to "Audio" port.

In "Global Parameters", "Call Settings" section (Figure 13) there are four parameters: "Call number", "Call trigger", "Ringtone", and "Auto answer". To initiate a call an appropriate digital input has to be selected as a "Call Trigger". To trigger the call selected input has to be connected to the ground. When the call is triggered, FM5500 dials the number which is defined in "Call Number" field. To initiate a call to FM5500 dial a number of the SIM card that is inserted in FM5500. When FM5500 has an incoming call it can play a selected tone from the "Ringtone" list. FM5500 will auto answer the call after number of rings defined in "Auto answer" field.

"Voice Settings" (Figure 13) section includes settings for "Microphone level" to regulate microphone sensitivity and "Speaker level" to define how loud will be the speaker.

For detailed "Voice Functionality" configuration parameters descriptions refer to chapter 5.5

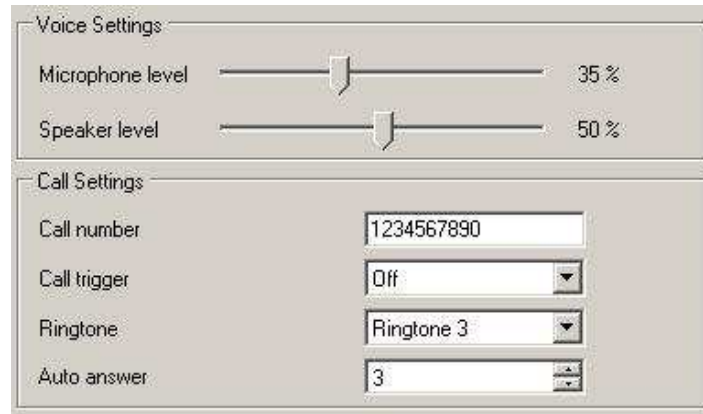

Figure 13 Voice and Call Settings

5.6 Profiles

FM5500 has 4 profiles saved in Flash memory of the module. Every profile has a list of parameters, which enables FM5500 to operate in different modes while using different profiles. The easiest way to understand what is a profile is to compare it to a list of instructions that are written for different cases. You are allowed to setup up to 4 different module behaviours. Global parameters contain settings that are common for all 4 profiles. This means that if FM5500 is set to call to predefined number, you will be able to call it while using any profile.

Profile 3 is default profile for FM5500 when SIM 1 Operator mode is enabled in Global parameter „Profile change on“. It is always loaded on the very first start-up and further profile switching is proceeded after operator scan or I/O element changes.

Switching between profiles (changing behaviour) can be performed by GSM Operator (mostly used for roaming applications), or by Profile switching depending on I/O Event (on I/O value changing).

More information about Profile switching functionalities in 1 SIM operational mode can be found in chapters 8.1 (Switching by GSM Operator) and 8.2 (Switching by I/O Element).

When DUAL SIM operating mode is used, profile switching becomes dependent on SIM switching algorithm, which is based on GSM Operator lists of both SIM cards. More information about Profile switching functionalities in DUAL SIM operational mode can be found in chapter 7 (DUAL SIM functionality).

5.7 Features

Using available features can greatly increase FM5500 usability options.

Scenarios

Four scenarios are available on FM53 device:

- a. Digital Output No.1 is used by scenarios - Eco Driving **and/or** Over Speeding;
- b. Digital Output No.2 is used by scenarios - Authorized Driving **or** Immobilizer.

Eco Driving Scenario. Gives the ability to periodically monitor driving characteristics and warn the driver against over accelerating, braking or cornering. More about Eco Driving read in chapter 12.1

Over Speeding Scenario. Helps to prevent from exceeding fixed speed and inspects driver if needed. DOUT1 is controlled by scenario for user needs, to manage buzzer, LED etc.

Authorized Driving Scenario. Gives ability to use vehicle only for 50 specific iButton owners (specified in iButton list). DOUT2 is controlled by scenario for user needs, to manage buzzer, LED etc.

Immobilizer Scenario. Vehicle can be used only if iButton is connected. In this scenario iButton list is not used - connect any iButton to pass Immobilizer security. DOUT2 is controlled by scenario for user needs.



Note: It is possible to use both Eco driving and Over Speeding scenarios at the same time, while Authorized Driving and Immobilizer are not – one of these has to be chosen.

Trip

Trip customizable feature enables user extended monitoring of performed trips (from engine start at present location to engine stop at arrived location), log their start and stop points, view driven total distance. Event will be **generated (included into send records) only** when trip starts and finishes.

Geofencing

Geofencing is another feature which is highly customizable and can detect wherever a car enters or leaves customized areas. More about Geofencing can be read in chapter Error! Reference source not found..

Auto Geofencing feature, if enabled, is activated automatically by turning off car ignition. Next time before driving user has to disable Auto Geofencing with iButton or by turning on car ignition. In case of theft, the car leaves Auto Geofencing zone without authorization and FM5500 device automatically sends high priority record to AVL application.

iButton list

iButton list is used to enter authorized iButton ID codes, which are used to authenticate driver in Authorized driving and Auto Geofencing options.

6 CONFIGURATOR

6.1 STARTUP

FM5500 configuration is performed via FM5500 Configurator program. FM5500 Configurator can be downloaded from <http://av1.teltonika.lt/downloads/FM55/>. Contact sales manager to get the latest FM5500 Configurator version. FM5500 configurator operates on Microsoft Windows OS and uses MS .Net Framework 3.5 or higher. Please ensure that MS .Net Framework 3.5 or later is installed on your PC before starting configurator. Latest MS .Net Framework version can be downloaded from official Microsoft web page.

Module configuration is performed over USB cable or COM1. Configuration process starts from starting FM5500 Configurator program and then connecting to FM5500 device via “Connect” button located on the top left corner of configurator. If one of the communication sources (USB cable or COM1) is connected to the device, the configurator will detect it automatically and if connected successfully IMEI, Version fields, which were empty, now are filled with certain numbers depending on Modem IMEI and firmware version of your device (Figure 14).

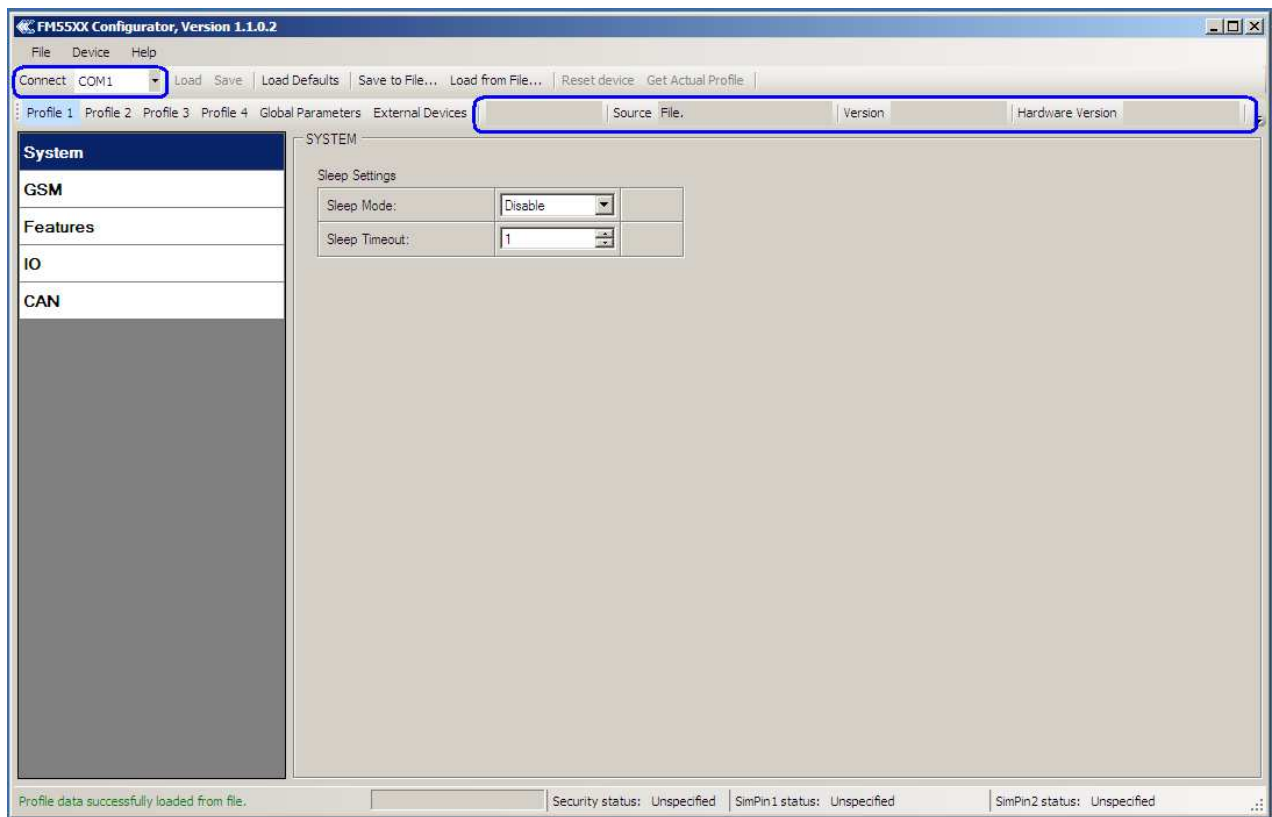

Figure 14 FM5500 Configurator window

6.2 Configurator structure

FM5500 has four user editable profiles, which can be both loaded and saved to the device. User can also revert to default settings, by pressing Load Defaults button. After any modification of configuration settings it has to be saved to FM5500 device, otherwise it will not be written to device flash memory.

FM5500 Configurator is divided into 5 main areas (Figure 15):

- Buttons area;
- Information area;
- Profiles or global parameters selection area;
- Settings menu;
- Configurable parameters and values menu.

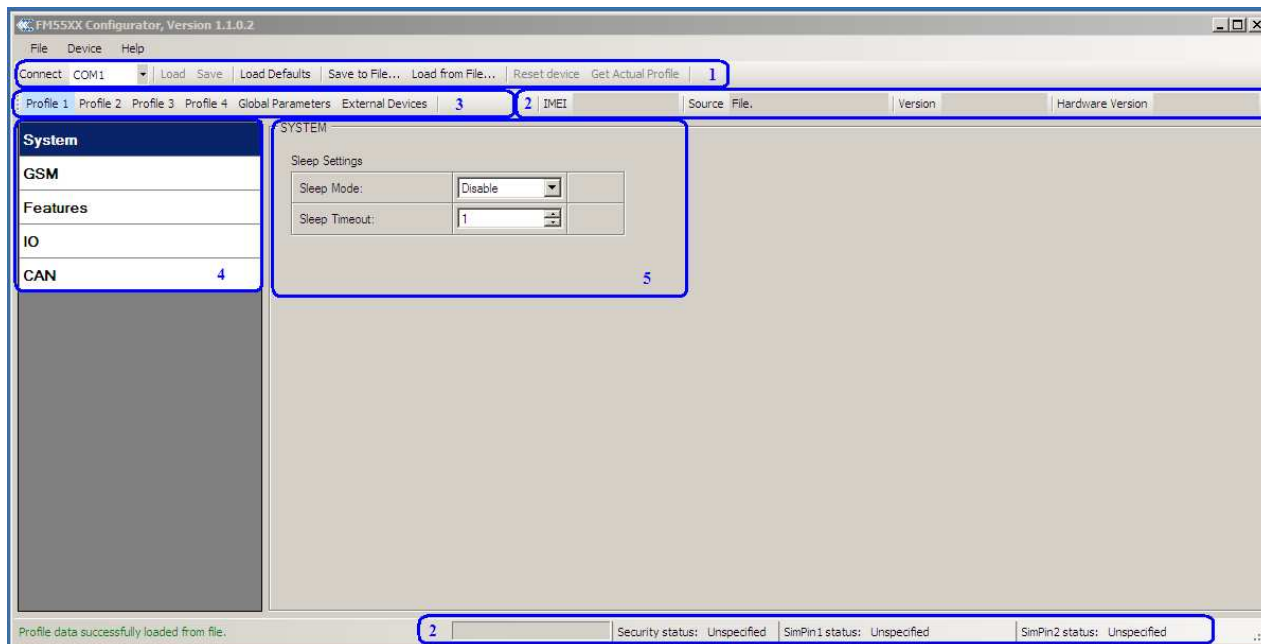

Figure 15 FM5500 Configurator window structure

Buttons area

Table 7 Configurator buttons area description

Main Buttons	
Button	Description
<i>Connect</i>	connects the device
<i>Load</i>	reads configuration parameters from FM5500 Flash memory
<i>Save</i>	saves configuration parameters to FM5500 Flash memory
<i>Load Defaults</i>	loads default FM5500 settings that later can be modified
<i>Save to File...</i>	allows user to save currently entered settings to .XML file for later usage
<i>Load from File...</i>	allows user to load configuration saved in .XML extension file
<i>Reset device</i>	reboots FM5500 and displays processor firmware version
Additional Buttons	
Button	Description
<i>SIM PIN</i>	allows to enter PIN code (visible only if PIN code request is enabled and PIN code is required) if inserted SIM card has activated PIN code security
<i>Add Keyword³ / Change Keyword / Switch Security Off</i>	buttons are used to protect configurator from unauthorized access to configuration

³ Keyword is of 4 - 10 symbol length (Latin text and/or numbers). If a keyword is set, every time user reconnects FM5300 to USB or COM1 port he will be asked to enter a valid keyword when connecting FM5300 to configurator. User is given 5 attempts to enter a valid keyword before blocking the configurator.

Information area

FM5500 information area is divided into 2 parts located on the top right and bottom of the configurator. When configurator is connected to the device via USB or COM1 port all necessary information about the device is shown here:

- IMEI – unique number for every FM5500 and usually servers recognize different devices by this number;
- SOURCE – configuration source (device or file);
- VERSION – firmware version of the device;
- HARDWARE VERSION – hardware version of the device;
- STATUS – status bar;
- SECURITY STATUS – status of the configurator security;
- SIM PIN STATUS – status of SIM card in the device;

Profiles/global parameters selection area

FM5500 has 4 user editable profiles stored in Flash no. 1-4 memories and one extra profile stored in Flash no. 0 which cannot be edited by user. Profile from Flash no. 0 is used by system and cannot be selected as active, while profiles from Flash no. 1-4 are fully editable and can be selected as active.

Reading profiles and Global parameters from Flash memory is a very simple procedure. By pressing “Load” button all 4 profiles and Global parameters are loaded to the configurator (Figure 16). To configure 3rd profile choose the TAB named “Profile 3” and all configurable parameters of this profile will be available to change.

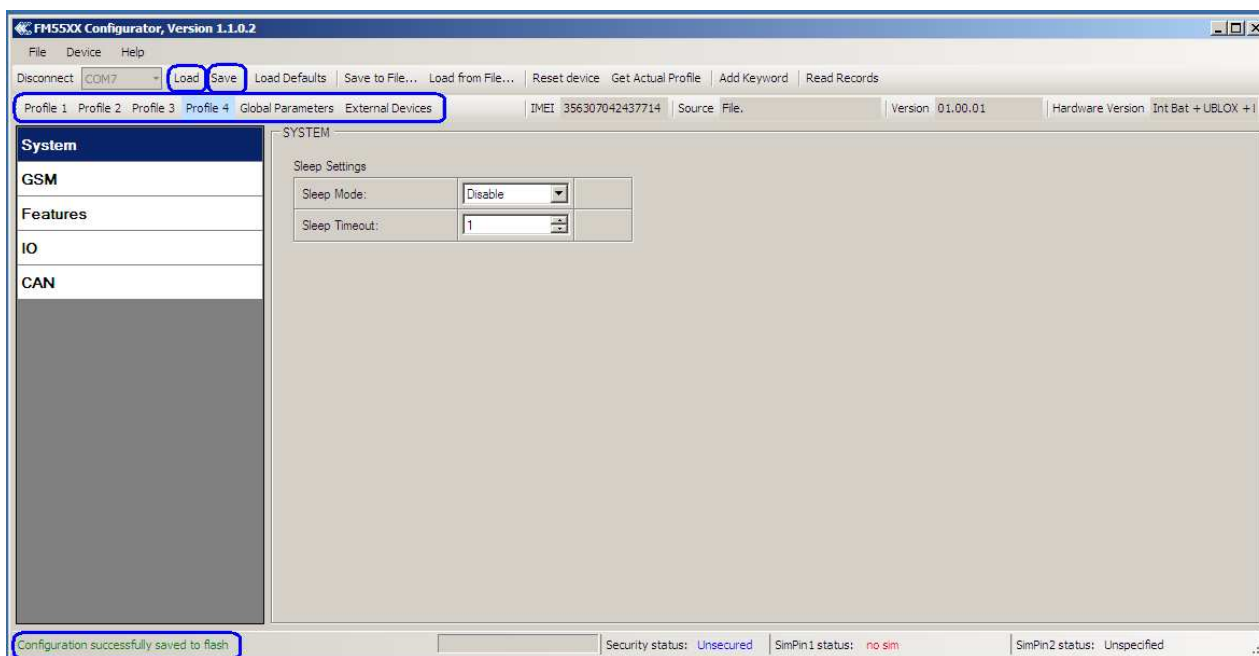

Figure 16 FM5500 Configurator profiles loading window

After changing profile and global parameters, changes can be saved to FM5500 Flash. By pressing “Save” button all 4 profiles and Global parameters are saved to the Flash (Figure 17).

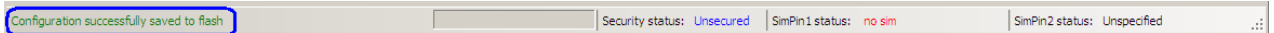

Figure 17 FM5500 Configurator profiles saving information

6.3 Parameters Configuration

Global parameters Settings

Global parameters do not depend on selected profile; they are common for all profiles. To configure these parameters choose the TAB named “Global Parameters” and make all necessary changes (Figure 18)

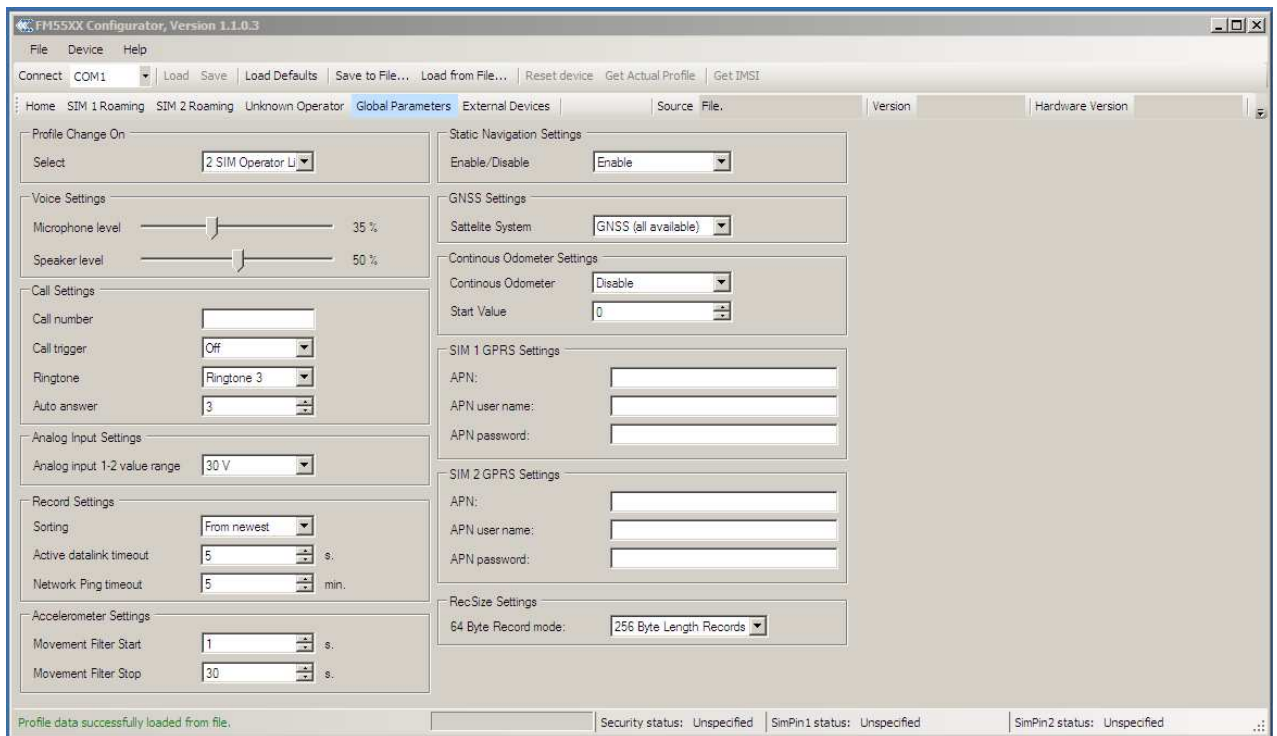

Figure 18 FM5500 Global parameters

Table 8 Global parameters description

Parameter Name	Parameter description
Profile change on event	Allows selecting profile switching method: 1 SIM Operator List, 1 SIM On Event, 2 SIM Operator List (see details in chapter 6.4).
Voice settings	Allows to setup microphone sensitivity and speaker loudness level.
Call Settings	Allows entering one number to which FM5500 will be able to call to. Call trigger defines input, which will be used to receive or make a call. Usually to that input a button is connected (“Digital Input 1” is not allowed, because this input is dedicated for ignition).
Record Settings	Are used to switch between two data sending modes: starting from newest records or starting from oldest record. Active data link timeout defines how many seconds should FM5500 keep connection to the server before disconnecting after successful data transfer. Note that even if it disconnects from server, it always keep active GPRS session.

Parameter Name	Parameter description
Analog input settings	Defines maximum input voltage on analog input. Possible cases are: all inputs 0-30V, 0-10V, two inputs 0-10V while other two 0-30V maximum input range has impact on precision – values on 0-10V input are measured more precisely than 0-30V (higher resolution).
Accelerometer settings	Defines accelerometer sensitivity range (0.5g, 1g, 1.5, 2g), how many seconds should movement be detected by accelerometer in order to set movement for FM5500 application and how many seconds after movement is not detected by accelerometer FM5500 application should treat like movement is still there.
Static Navigation settings	Allows enabling or disabling functionality.
GNSS Settings	Allows choosing compatibility mode and satellite System.
COM1 Settings	Allows configuring COM1 baud rate, parity and flowing control.
COM2 Settings	Allows configuring COM2 baud rate, parity mode, end line, binary timeout and 3 prefixes.
Temperature Settings	When two or three temperature sensors are connected to FM5500 it is necessary to define sensor ID to certain property separately. This way FM5500 will know which temperature sensor is which property. FM5500 automatically updates ID's field if any sensors are connected while configuring device via configurator.
Continuous Odometer settings	Allows enabling or disabling functionality and start value setting.
Garmin settings	Allows enabling or disabling functionality and Unicode.
SIM 1 GPRS Settings	Allows to insert SIM 1 APN, APN user name and APN password
SIM 2 GPRS Settings	Allows to insert SIM 2 APN, APN user name and APN password

Settings and configurable parameters menu

Every FM55 profile has four main groups of parameters:

1. System – main parameters for all device;
2. GSM has 3 subgroups
 - a. GPRS
 - b. SMS
 - c. OPERATOR LIST
3. Features
4. I/O

6.3.1.1 System Settings

System settings have 1 configurable parameter (Figure 19):

- Sleep settings, where user can disable sleep, turn on sleep mode or deep sleep.

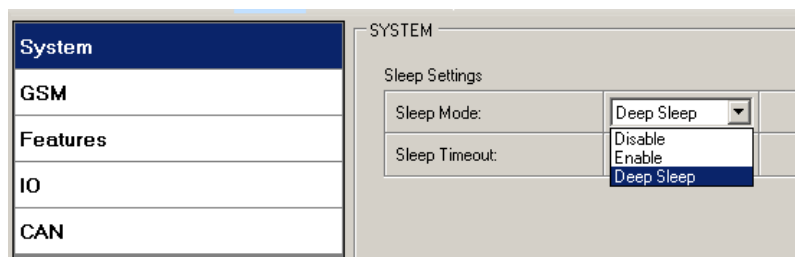

Figure 19 System Settings Configuration

6.3.1.2 GSM Settings

6.3.1.2.1 GPRS

'GPRS' defines main parameters for FM5500: destination server Domain (can be entered either IP or domain name) and port. Also both TCP and UDP protocols are supported.

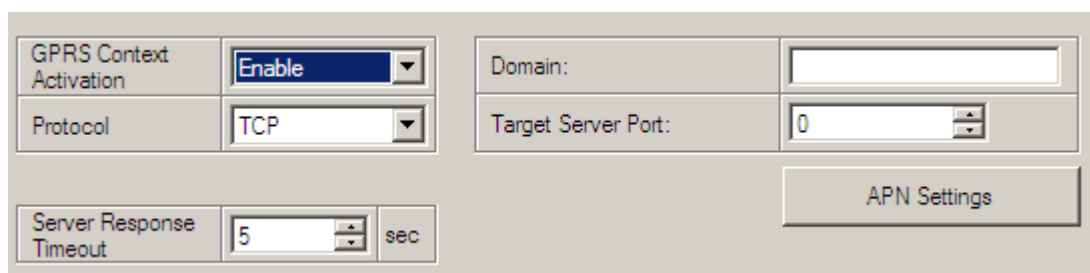

Figure 20 GSM->GPRS Settings Configuration

APN settings are set in Global parameters screen, if SIM 1 Operator mode is used, than user should insert the same APN settings form both SIM 1 and SIM 2 and insert SIM card into either SIM 1 slot or SIM 2 slot.

6.3.1.2.2 SMS

Essential fields in 'SMS' part is 'Login' and 'Password' (Figure 21). This login and password is used with every SMS sent to FM5500. If login and password are not set, every SMS sent to FM5500 device has to include two spaces before command (<space><space><command>).

Command structure: <login><space><password><space><command>.

Examples:

1. SMS login and password are set - "asd 123 getgps"
2. SMS login and password are not set - " getgps"



Phone numbers have to be written in international standard, without using "+" or "00" signs in prefix. **If no numbers are entered in configuration then commands SMS are allowed to be sent from all GSM numbers.**

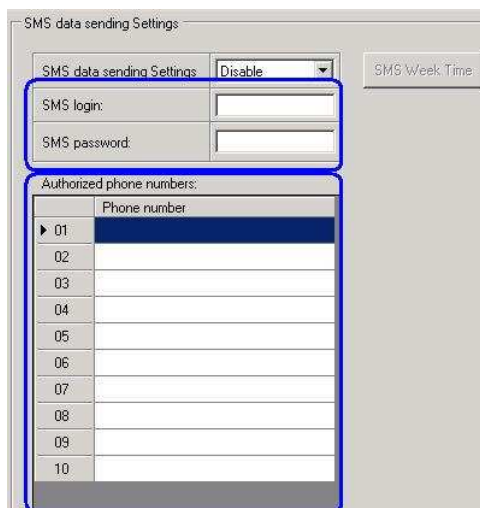

Figure 21 GSM->SMS Settings Configuration (1)

SMS data sending Settings enables or disables **periodic** data and event SMS sending to server (Figure 22). Configuration is divided into 3 main parts:

1. Enable/Disable functionality;
2. SMS Week Time button (can be pressed only if functionality is Enabled);
3. Server Phone Number (has to be written in first position of Authorized phone numbers);

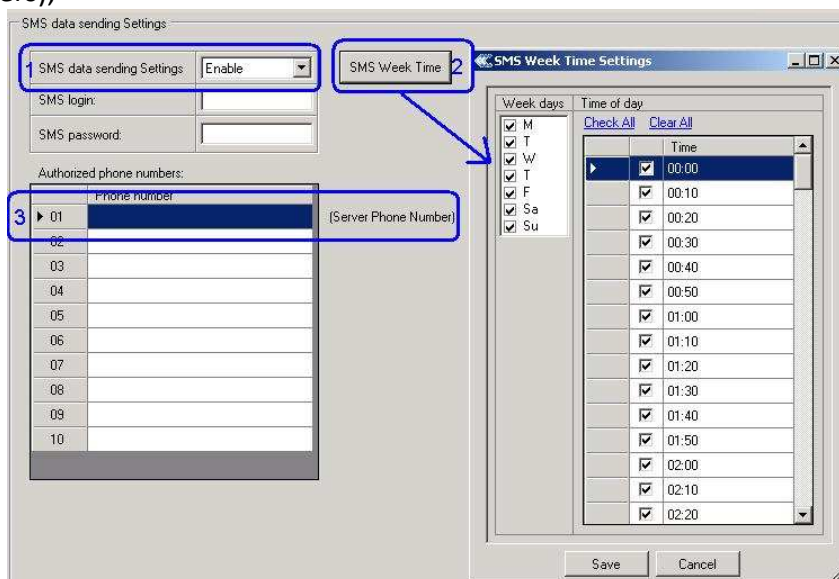

Figure 22 GSM->SMS Settings Configuration (2)

Using these settings FM5500 can send SMS with 24-coordinates in one SMS; it is used in areas where no GPRS coverage is available. Module collects data and sends to server binary SMS containing information about last 24 collected points. SMS sending schedule is set in SMS Week Time tab. 24-Coordinates SMS decoding is described in “FMXXXX Protocols” document.

6.3.1.2.3 Operator List

FM5500 is able to use GPRS with all operators but if at least one operator is entered in the list, FM5500 is allowed to connect to GPRS only while operating in listed operator’s network. Also

operator list has influence on profile switching (see details in chapter 7.1 and chapter 8) if Global parameter „Profile switching on” value „SIM 1 Operator list” or „SIM 2 Operator list” is enabled.



The screenshot shows a configuration window titled "Operator List". Inside, there is a section labeled "Preferred Roaming Operator List:" containing a table with the following data:

	Code
▶ 01	0
02	0
03	0
04	0

Figure 23 FM55 Operator List Configuration

6.3.1.3 Features

6.3.1.3.1 Mode

FM5500 is able to collect records using three methods at the same time: time, distance and angle based data acquisition (chapter 9). Send and Save Parameters configuration is available in Features->Mode category (Figure 24):

- Min Period – time period change that initializes record save (chapter 9.1).
- Min Angle – angle change that initializes record save (only if vehicle is moving) (chapter 9.1).
- Min Distance – distance change that initializes record save (only if vehicle is moving) (chapter 9.1).
- Send period – GPRS data sending to server period. Module makes attempts to send collected data to server every defined period. If it does not have enough records (depends on parameter Min. Saved Records described above), it tries again after defined time interval.
- GPRS Context Week Time tab – most GSM billing systems charge number of bytes (kilobytes) transmitted per session. During the session FM5500 makes connection and transmits data to a server. FM5500 tries to control the session as much as possible. Session can last hours, days, weeks or session can be closed after every connection in certain GSM networks – this depends on GSM network provider. GPRS Context Week Time defines session re-establishing schedule if session was closed by network. New GPRS context is opened if 10 minutes are left till time checked in table. Therefore if all boxes are checked, FM5500 is able to open new connection anytime. At scheduled time match FM5500 checks for GPRS session activity. If GPRS session is alive, FM5500 sends data to server according to Send period parameter. If it is not, FM53 checks if it is able to re-establish the session.

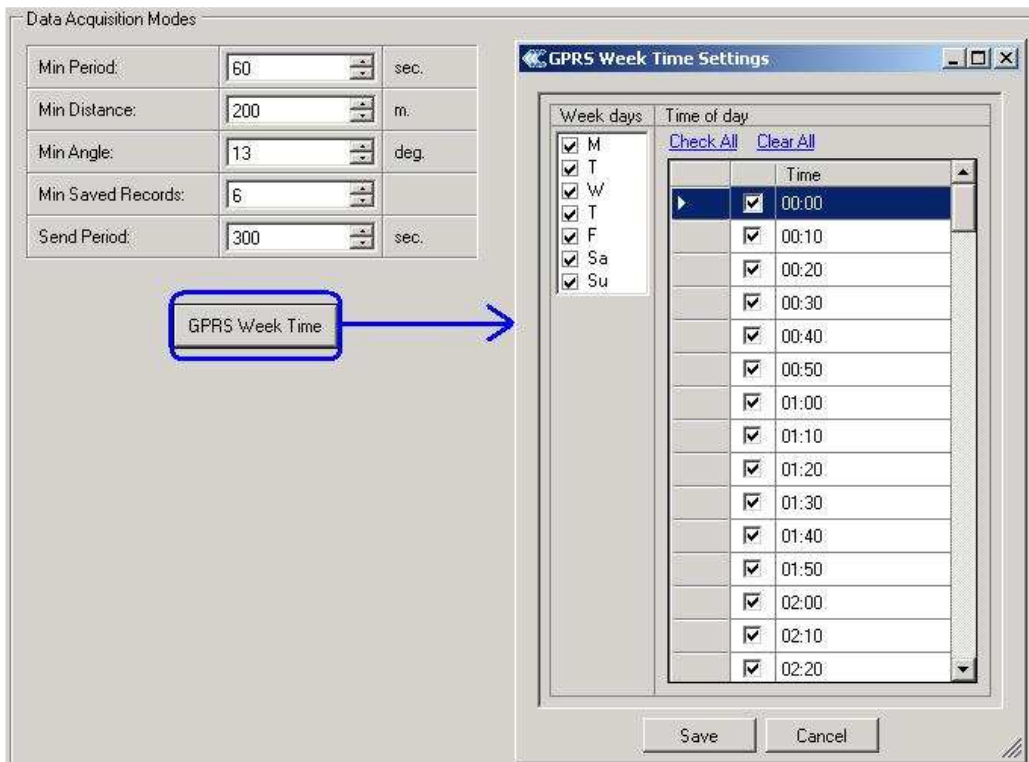

Figure 24 FM55 Features->Mode Configuration

6.3.1.3.2 Scenarios

In Scenarios window four different scenarios are available, two per each Digital Output (DOUT). Only one per digital output can be active at a same time, e.g. DOUT1 can have either ECO driving or Over Speeding enabled, DOUT2 can have either Authorized Driving or Immobilizer enabled.

Scenarios configurable parameters are shown in Figure 25. All values of these parameters are described in chapter 12.

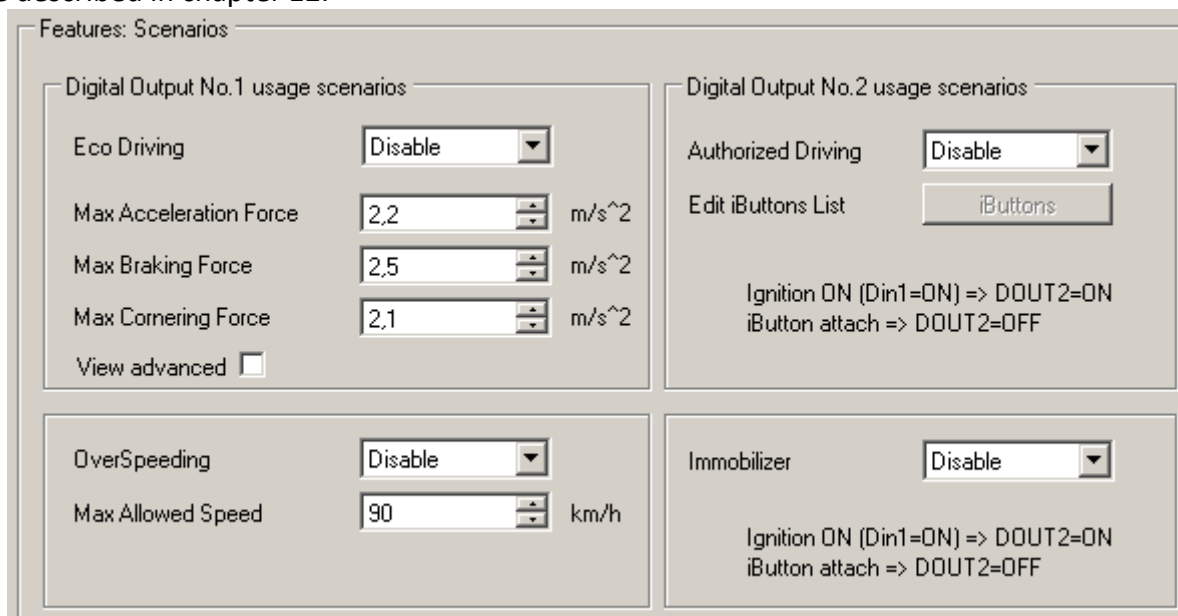

Figure 25 FM55 Features->Scenarios Configuration

6.3.1.3.3 Trip

Trip window offers user to configure Trip feature. If Trip is enabled configuration of parameters is available:

- Start Speed – speed, which is detected as minimum speed to indicate Trip start.
- Ignition Off Timeout – timeout to wait if ignition was off, to detect Trip stop.
- Continuous distance counting – Not or Continuous can be chosen. For this feature I/O Odometer must be enabled.

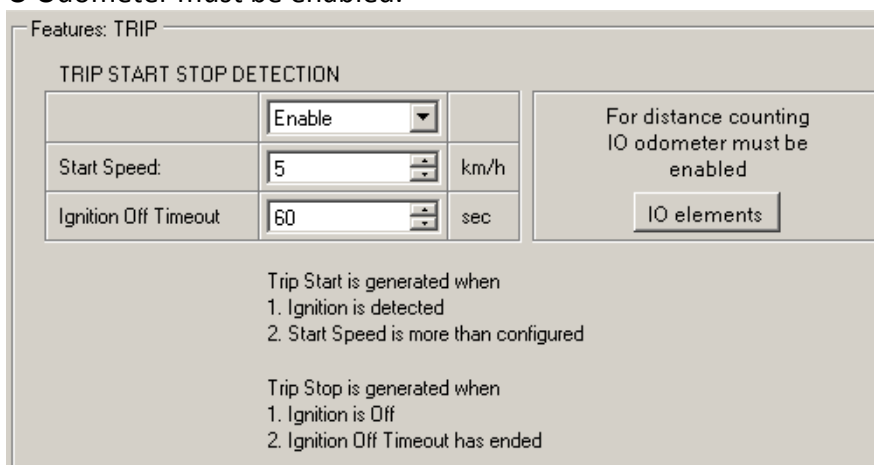

Figure 26 FM55 Features->Trip Configuration

If I/O Odometer is enabled and Continuous distance counting variable is set to Continuous, Trip distance is going to be counted continuously (from Trip start to Trip stop). This value is written to I/O Odometer value field. When Trip is over and next Trip begins, Odometer value is not reset to zero, it is counted continuously again.

If I/O Odometer is enabled and Continuous Distance Counting variable is set to Not, then distance is going to be counted only between every record made. This value is written to I/O Odometer value field and reset to zero every new record until Trip stops. If later all Odometer values are summed up manually user gets distance driven over the whole Trip period.

6.3.1.3.4 Geofencing

6.3.1.3.4.1 Geofencing settings

FM5500 has 20 configurable Geofence zones and it can generate event when defined Geofence zone border has been crossed.

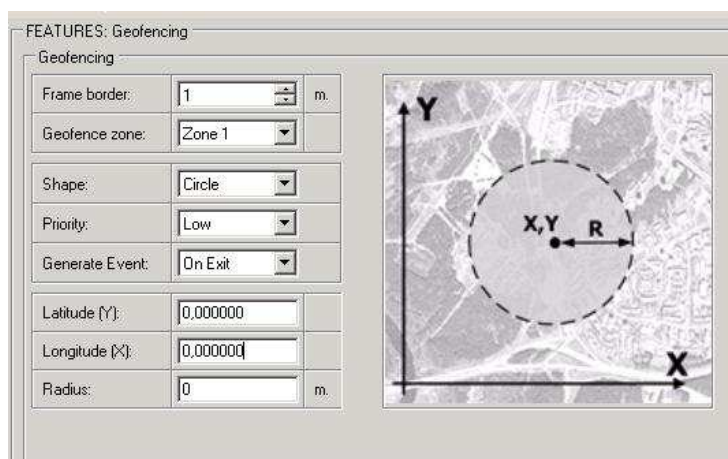

Figure 27 FM55 Features->Geofencing Configuration (1)

Configuration of the parameters is available in Features->Geofencing (Figure 27)

- Frame border – frame border is an additional border around Geofence zone. It is additional area around defined zone used to prevent false event recording when object stops on the border of the area and because of GPS errors some records are made inside area and some – outside. Event is generated only when both borders are crossed. See figure for details: track 1 is considered to enter the area while track 2 does not.

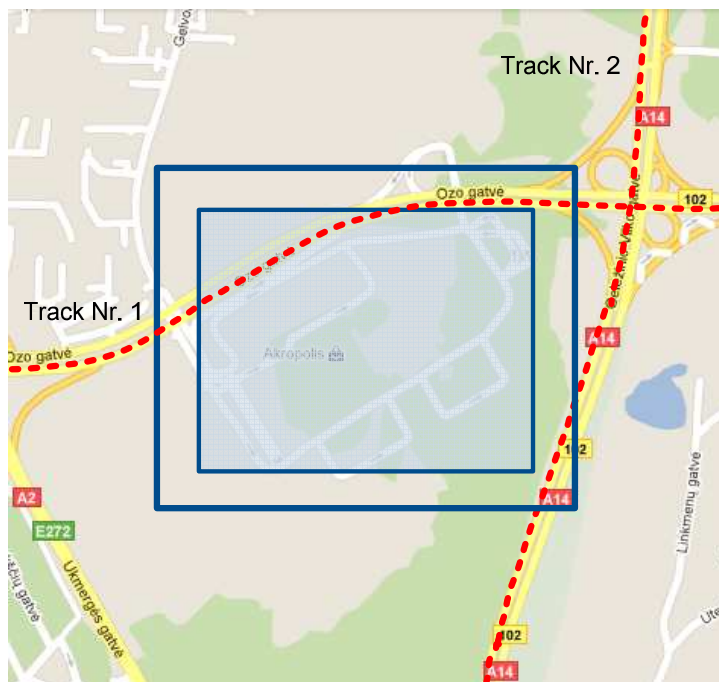

Figure 28 Geofence border

- Shape – can be rectangular or circle
- Priority – priority of Geofence event: low, high or panic, SW21, SW22, SW23, SW24. These levels define priority of event information sending to server. See I/O element description for more details about priorities.
- Generate event (On entrance, On exit, On both) – choose when record will be generated (or no event);
- X1 – geofence zone left bottom corner X coordinate;
- Y1 – geofence zone left bottom corner Y coordinate;
- X2 or R – geofence zone upper right corner X coordinate (radius of circle when Circular zone used);
- Y2 – geofence zone upper right corner Y coordinate;

6.3.1.3.4.2 AutoGeofencing settings

AutoGeofence – the last known position after movement = off. If your car is being taken away – you can be notified. The shape and size of the geofence zones are configurable. There is a possibility to state whether entering in or out of the geofence triggers an asynchronous message.

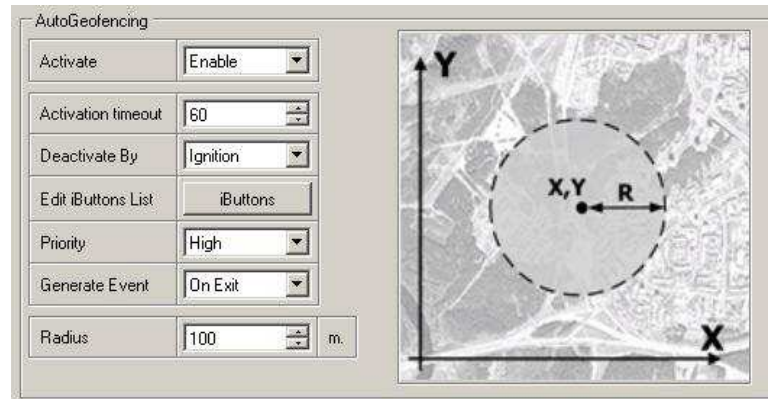

Figure 29 FM55 Features->Geofencing Configuration (2)

Auto Geofencing option can be configured by following parameters (Figure 29):

- Activate – Enable or Disable Autogeofence functionality
- Activation TMO – Time period before Geofence is activated after vehicle stops.
- Deactivate By:
 - Ignition – if ignition becomes high it will drop AutoGeofence Zone
 - iButton – if iButton is attached it will drop AutoGeofence Zone
- Edit iButton List – if list is not empty, attached iButton is tested against iButton list, if match is found AutoGeofence zone is dropped.
- Priority – Priority of generated event, which will be applied to saved record.
- Generate Event:
 - Enter Event – Event generation on Geofence entrance.
 - Exit Event – Event generation on Geofence exit.
 - On Both - Event generation on Geofence entrance or exit.
 - No Event

Auto Geofencing does not require entering coordinates, instead it requires GPS visibility. If vehicle stopped and activation timeout is reached, Auto Geofence will be created around the vehicles last position by set Radius value. Auto Geofence event generation works the same as Geofencing mentioned above.

6.3.1.3.5 iButton List

iButton list is used to enter authorized iButton ID codes, which are used to authenticate driver in Authorized driving and Auto Geofencing options.

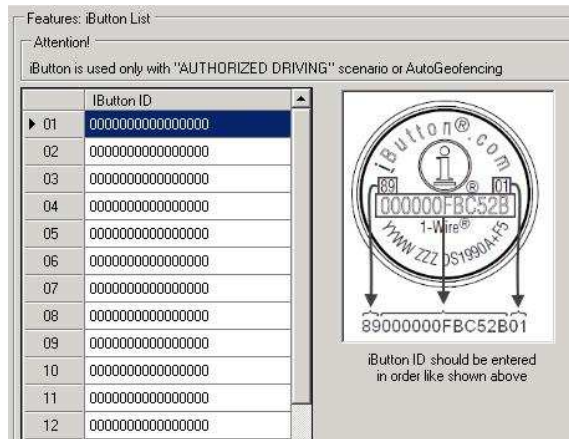

Figure 30 Features->iButton Configuration

iButton value must be entered as it is written on it.

6.3.1.4 I/O

If all I/O elements are disabled AVL packet comes with GPS information only. After enabling I/O element(s) AVL packet in couple with GPS information contains current value(s) of enabled I/O element.

6.3.1.4.1 FM5500 available I/O list

Table 9 PERMANENT I/O elements list description

Permanent I/O elements (are always sent (with every record) to server if enabled)			
Property ID in AVL packet	Property Name	Bytes	Description
1	Digital Input Status 1	1	Logic: 0 / 1
2	Digital Input Status 2	1	Logic: 0 / 1
3	Digital Input Status 3	1	Logic: 0 / 1
4	Digital Input Status 4	1	Logic: 0 / 1
9	Analog Input 1	2	Voltage: mV, 0 – 30 V
10	Analog Input 2	2	Voltage: mV, 0 – 30 V
11	Analog Input 3	2	Voltage: mV, 0 – 30 V
19	Analog Input 4	2	Voltage: mV, 0 – 30 V
21	GSM signal level	1	Value in scale 1 – 5
22	Actual profile	1	Value in scale 1 – 4
24	Speedometer	2	Value in km/h, 0 – xxx km/h
66	External Power Voltage	2	Voltage: mV, 0 – 30 V
67	Internal Battery Voltage	2	Voltage: mV
68	Internal Battery Current	2	Voltage: mA
70	PCB Temperature	4	10 * Degrees (°C)
71	GNSS status	1	0-off/ 1-no antenna (only when using NAVYS)/ 2- no fix/ 3-got fix/ 4-sleep/ 5-over current
72	Dallas Temperature 1	4	10 * Degrees (°C), -55 - +115, if 3000 – Dallas error
73	Dallas Temperature 2	4	10 * Degrees (°C), -55 - +115, if 3000 – Dallas error
74	Dallas Temperature 3	4	10 * Degrees (°C), -55 - +115, if 3000 – Dallas error

Permanent I/O elements (are always sent (with every record) to server if enabled)			
Property ID in AVL packet	Property Name	Bytes	Description
76	Fuel Counter	4	Difference of generated impulses on two signal lines
78	iButton ID	8	iButton ID number
179	Digital Output Status 1	1	Logic: 0 / 1
180	Digital Output Status 2	1	Logic: 0 / 1
50	Digital Output Status 3	1	Logic: 0 / 1
51	Digital Output Status 4	1	Logic: 0 / 1
181	GPS PDOP	2	Probability * 10; 0-500
182	GPS HDOP	2	Probability * 10; 0-500
199	Odometer	4	Distance between two records: m
200	Deep Sleep	1	0 – not deep sleep mode, 1 – deep sleep mode
205	Cell ID	2	GSM base station ID
206	Area Code	2	Location Area code (LAC), it depends on GSM operator. It provides unique number which assigned to a set of base GSM stations. Max value: 65536
240	Movement	1	0 – not moving, 1 – moving.
241	Current Operator Code	4	Currently used GSM Operator code
201	Fuel level meter 1	2	Fuel level, measured by LLS sensor on COM1, in kvants or liters.
202	Fuel temperature 1	1	Fuel temperature, measured by LLS sensor on COM1, in degrees Celsius.
203	Fuel level meter 2	2	Fuel level, measured by LLS sensor on COM2, in kvants or liters.
204	Fuel temperature 2	1	Fuel temperature, measured by LLS sensor on COM2, in degrees Celsius.
207	RFID ID	8	Read RFID value, depending on RFID mode, values can be: for RFID mode in hexadecimal format, RFID M7 mode in decimal format.

Table 10 EVENTUAL I/O elements list description

Eventual IO elements (generated and sent record to server only if appropriate conditions are met)			
Property ID in AVL packet	Property Name	Bytes	Description
145	CAN 0	Varying ⁴	ID Specific data
146	CAN 1	Varying	ID Specific data
147	CAN 2	Varying	ID Specific data
148	CAN 3	Varying	ID Specific data
149	CAN 4	Varying	ID Specific data
155	Geofence zone 01	1	Event: 0 – target left zone, 1 – target entered zone
156	Geofence zone 02	1	Event: 0 – target left zone, 1 – target entered zone

⁴ CAN property length can vary depending on filter settings. Data can be sent as 1, 2, 4 or 8 byte property.

Eventual IO elements (generated and sent record to server only if appropriate conditions are met)			
Property ID in AVL packet	Property Name	Bytes	Description
157	Geofence zone 03	1	Event: 0 – target left zone, 1 – target entered zone
158	Geofence zone 04	1	Event: 0 – target left zone, 1 – target entered zone
159	Geofence zone 05	1	Event: 0 – target left zone, 1 – target entered zone
160	Geofence zone 06	1	Event: 0 – target left zone, 1 – target entered zone
161	Geofence zone 07	1	Event: 0 – target left zone, 1 – target entered zone
162	Geofence zone 08	1	Event: 0 – target left zone, 1 – target entered zone
163	Geofence zone 09	1	Event: 0 – target left zone, 1 – target entered zone
164	Geofence zone 10	1	Event: 0 – target left zone, 1 – target entered zone
165	Geofence zone 11	1	Event: 0 – target left zone, 1 – target entered zone
166	Geofence zone 12	1	Event: 0 – target left zone, 1 – target entered zone
167	Geofence zone 13	1	Event: 0 – target left zone, 1 – target entered zone
168	Geofence zone 14	1	Event: 0 – target left zone, 1 – target entered zone
169	Geofence zone 15	1	Event: 0 – target left zone, 1 – target entered zone
170	Geofence zone 16	1	Event: 0 – target left zone, 1 – target entered zone
171	Geofence zone 17	1	Event: 0 – target left zone, 1 – target entered zone
172	Geofence zone 18	1	Event: 0 – target left zone, 1 – target entered zone
173	Geofence zone 19	1	Event: 0 – target left zone, 1 – target entered zone
174	Geofence zone 20	1	Event: 0 – target left zone, 1 – target entered zone
175	Auto Geofence	1	Event: 0 – target left zone, 1 – target entered zone
230	SIM 1 IMSI	4	6 last numbers of SIM 1 IMSI
231	SIM 2 IMSI	4	6 last numbers of SIM 2 IMSI
232	Active SIM slot	1	0 – Active SIM 1 slot, 1 – Active SIM 2 slot
250	Trip	1	1 – trip start, 0 – trip stop
251	Immobilizer	1	1 – iButton connected
252	Authorized driving	1	1 – authorized iButton connected
253	ECO driving type	1	1 – harsh acceleration, 2 – harsh braking, 3 - harsh cornering
254	ECO driving value	1	Depending on eco driving type: if harsh acceleration, braking and cornering – $g \cdot 10 \text{ m/s}^2$
255	Over Speeding	1	At over speeding start km/h, at over speeding end km/h



There are two types of operations with Permanent I/O elements: simple monitoring and event generating. Monitoring method is used when current I/O information needed with regular GPS coordinates. Event generating method is used when additional AVL packet is needed when current value of I/O exceeds predefined High and Low levels. I/O settings allow defining I/O event criteria.

6.3.1.4.2 I/O configuring

I/O configuration has 8 main parts (Figure 31):

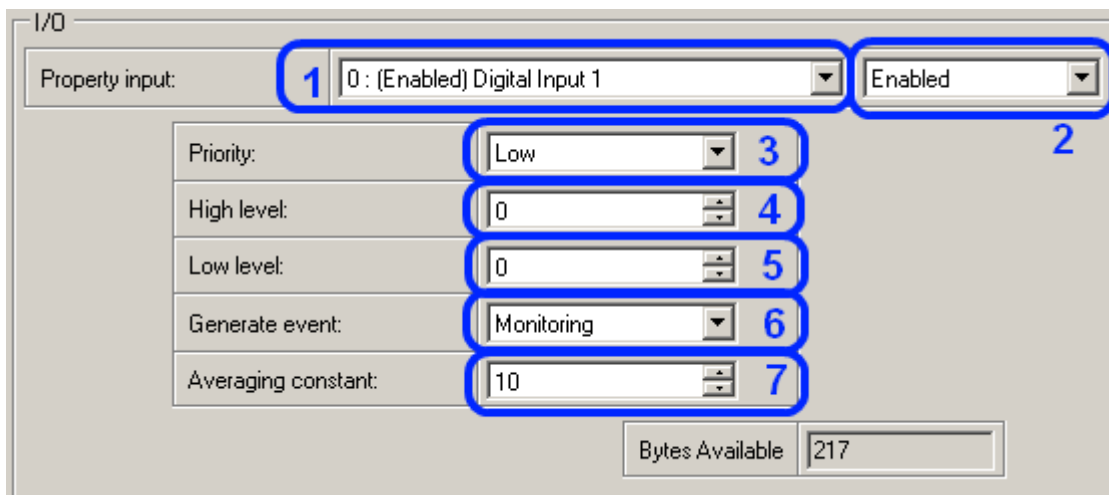

Figure 31 FM55 I/O Configuration (1)

Table 11 I/O Configuration window description

Pos. Nr.	DESCRIPTION
1.	Property inputs list
2.	Enable/Disable chosen property input - allows enabling I/O element so it is added to the data packet and is sent to the server. By default, all I/O elements are disabled and FM5500 records only GPS information. It is also possible to set CAN message instead of any I/O element – this way CAN element will be sent to the server instead of chosen element. See CAN description below for more details (see chapter 14).
3.	Priority - AVL packet priority. There are Low, High, Panic, SW21, SW22, SW23 and SW24 priorities. Regular packets are sent as Low priority records. When low priority event is triggered, FM5500 makes additional record with indication that the reason for that was I/O element change. When High priority is selected, module makes additional record with high priority flag and sends event packet immediately to the server. First it tries to send it using GPRS. If GPRS fails, it doesn't send AVL packet using SMS mode, if SMS is enabled in SMS settings. Panic priority event forces module to send AVL packet to server via GPRS and if GPRS fails, it sends AVL packet using SMS mode, if SMS is enabled in SMS settings. Then it switches its operating profile to Profile 4 (for details see chapter 8.1). SW2X priorities switch profiles on event (SW21 – Profile 1, SW22 – Profile 2 and so on).
4.	High Level - define I/O value range. If I/O value enters or exits this range, FM5500 generates event.
5.	Low Level – define I/O value range. If I/O value enters or exits this range, FM5500 generates event.
6.	Generate event – defines when to generate event. When value enters defined range, exits it or both enters and exits.
7.	Averaging Constant – it is an I/O event delay parameter. In some applications there is no need to generate events on every I/O range enter/exit immediately. Sometimes it is necessary to wait some time interval before event generating to be ensuring that current event is not a short time event. Averaging constant allows setting I/O event delay (averaging). If I/O value is entering or leaving predefined range, it must have same value for Averaging constant time. One unit of averaging constant value equals 20 milliseconds.

Pos. Nr.	DESCRIPTION
	<p>Selected data source value input averaging constant are calculated by following formula:</p> $VAL^{Mean} = \frac{VAL^{Mean-1} \times (CONST - 1) + REALVAL}{CONST}$ <p>Where: VAL^{Mean} – Value calculated during actual cycle⁵; VAL^{Mean-1} – Value calculated during previous cycle; CONST – Averaging constant; REALVAL – Real value detected on digital input.</p>

6.3.1.4.3 I/O properties

I/O properties are additional data sources, which are recorded along with usual GPS data.

I/O#0 property parameter (ID=300)

Parameter defines I/O property value. Possible values are given below.

Table 12 I/O Parameter Values

0	1	2	3	4	5	6
Disabled	Enabled	CAN0	CAN1	CAN2	CAN3	CAN4

If value is 'CAN', then CAN data is automatically added to this property.

Table 13 I/O Property Parameter Values

Minimum value	Maximum value	Recommended value	Goes with (depends on) parameters	Value type
0	11	-	I/O#0 priority (ID=301) I/O#0 High level (ID=302) I/O#0 Low level (ID=303) I/O#0 logic operand (ID=304) I/O#0 averaging constant (ID=305)	S8

I/O#0 priority (ID=301)

Parameter defines I/O property type of priority: 0 is low, 1 – high, 2 – panic, 3 – empty, 4 – SW21, 5 – SW22, 6 – SW23, 7 –SW24.

Table 14 I/O Type of Priority

Minimum value	Maximum value	Recommended value	Goes with (depends on) parameters	Value type
0	7 (exl. 3)	0	I/O#0 High level (ID=302) I/O#0 Low level (ID=303) I/O#0 logic operand (ID=304) I/O#0 averaging constant	S8

⁵ One cycle equal to 20 ms.

			(ID=305)	
--	--	--	----------	--

I/O#0 High level (ID=302)

Parameter defines high value of triggered I/O property. This parameter is used to set thresholds for I/O properties to generate events.

Table 15 I/O High Value

Minimum value	Maximum value	Recommended value	Goes with (depends on) parameters	Value type
0	9999999	1	I/O#0 priority (ID=301) I/O#0 Low level (ID=303) I/O#0 logic operand (ID=304) I/O#0 averaging constant (ID=305)	S32

I/O#0 Low level (ID=303)

Parameter defines low value of triggered I/O property. This parameter is used to set thresholds for I/O properties to generate events.

Table 16 I/O Low Value

Minimum value	Maximum value	Recommended value	Goes with (depends on) parameters	Value type
0	9999999	0	I/O#0 priority (ID=301) I/O#0 High level (ID=302) I/O#0 logic operand (ID=304) I/O#0 averaging constant (ID=305)	S32

I/O#0 logic operand (ID=304)

Parameter defines when event is sent: 0 is event on exit, 1 – on entrance, 2 – on both, 3 – monitoring, 4 – hysteresis, 5 – on change.

Table 17 I/O Logic Operand

Minimal value	Maximum value	Recommended value	Goes with (depends on) parameters	Value type
0	5	2	I/O#0 priority (ID=301) I/O#0 High level (ID=302) I/O#0 Low level (ID=303) I/O#0 averaging constant (ID=305) I/O#0 property parameter (ID=300)	S8

I/O#0 averaging constant (ID=305)

Parameter defines I/O property sample length to average. If no averaging needed default value is 1.

Table 18 I/O Averaging constant

Minimum value	Maximum value	Recommended value	Goes with (depends on) parameters	Value type
1	99999999	1	I/O#0 property parameter (ID=300) I/O#0 priority (ID=301) I/O#0 High level (ID=302) I/O#0 Low level (ID=303) I/O#0 logic operand (ID=304)	S32

Other I/O property elements can be configured in the same logic. All I/O element parameters are listed below.

Table 19 I/O Elements

I/O Element Number	I/O element parameters	I/O Element Number	I/O element parameters
I/O#0 – Digital input 1	300 – 305	I/O#17 – Ext. Voltage	470 – 475
I/O#1 – Digital input 2	310 – 315	I/O#18 – GNSS Status	480 – 485
I/O#2 – Digital input 3	320 – 325	I/O#19 – Movement	490 – 495
I/O#3 – Digital input 4	330 – 335	I/O#20 – Odometer	500 – 505
I/O#4 – Analog input 1	340 – 345	I/O#21 – GSM Operator	510 – 515
I/O#5 – Analog input 2	350 – 355	I/O#22 – Speedometer	520 – 525
I/O#6 – Analog input 3	360 – 365	I/O#23 – iButton ID	530 – 535
I/O#7 – Analog input 4	370 – 375	I/O#24 – GSM Signal	540 – 545
I/O#8 – Current Profile	380 – 385	I/O#25 – Deep Sleep	550 – 555
I/O#9 – Battery voltage	390 – 395	I/O#26 – Cell ID	560 – 565
I/O#10 – Battery Current	400 – 405	I/O#27 – Area Code	570 – 575
I/O#11 – Fuel level meter 1	410 – 415	I/O#28 – PCB Temp.	580 – 585
I/O#12 – Fuel temperature 1	420 – 425	I/O#29 – Dallas Temp. 1	590 – 595
I/O#13 – Fuel level meter 2	430 – 435	I/O#30 – Dallas Temp. 2	600 – 605
I/O#14 – Fuel temperature 2	440 – 445	I/O#31 – Dallas Temp. 3	610 – 615
I/O#15 – GPS PDOP	450 – 455	I/O#32 – Fuel Counter	620 – 625
I/O#16 – GPS HDOP	460 – 465	I/O#33 – RFID ID	630 – 635

6.3.1.5 CAN

CAN - Controller Area Network (CAN or CAN-bus) is a computer network protocol and bus standard designed to allow microcontrollers and devices to communicate with each other and without a host computer (see chapter 12).

6.3.1.5.1 CAN interface parameters

CAN Baud Rate (ID=760)

Parameter defines CAN bus baud rate. For Auto Baud rate ID=760 value is 0. Available baud rates are 50, 100, 125, 250, 500 and 1000 kbps.

Table 20 CAN Baud Rate

Minimum value	Maximum value	Recommended value	Goes with (depends on) parameters	Value type
0	1000	125	CAN#0 CAN Type ID (ID=770) CAN#0 Output data mask (ID=771) CAN#0 CAN ID (ID=772)	U32

CAN#0 CAN Type ID (ID=770)

Parameter defines CAN element ID length. CAN element ID could be 11 or 29 bits length. For 11 bits ID parameter value is 0, for 29 bits ID – 1.

Table 21 CAN Type ID

Minimum value	Maximum value	Recommended value	Goes with (depends on) parameters	Value type
0	1	1	CAN#0 Output data mask (ID=771) CAN#0 CAN ID (ID=772)	U8

CAN#0 Output data mask (ID=771)

Parameter defines CAN data mask. This parameter is 8 bit length and indicates which data bytes of CAN message are sent for calculation and which are ignored. Bit value 1 means that CAN data byte will be preceded and sent to server.

Example: 00110011 is 51 integer.

Table 22 Output data mask

Minimum value	Maximum value	Recommended value	Goes with (depends on) parameters	Value type
0	FF	-	CAN#0 CAN Type ID (ID=770) CAN#0 CAN ID (ID=772)	U8

CAN#0 CAN ID (ID=772)

Parameter defines CAN identifier. ID can be 11 or 29 bits length.

Example: 18FEE925 (total fuel used)

Table 23 CAN ID

Minimum value	Maximum value	Recommended value	Goes with (depends on) parameters	Value type
0	FFFFFFFF	-	CAN#0 CAN Type ID (ID=770) CAN#0 Output data mask (ID=771)	U32

The rest CAN elements are configured in the same sequence. CAN elements and parameters ID's are listed below.

Table 24 CAN elements and parameters

CAN Element Number	CAN Element parameters
CAN#0	770 – 772
CAN#1	780 – 782
CAN#2	790 – 792
CAN#3	800 – 802
CAN#4	810 – 812



There are only 14 I/O parameters that could use Averaging Constant: Digital Inputs (1-4); Analog Inputs (1-4); Battery Voltage; Battery Current; External Voltage; PDOP; HDOP; Speedometer.

I/O parameters: “Current Profile”, “Fuel level meter” (1-2), “Fuel temperature” (1-2), “GNSS Status”, “Movement”, “Active GSM Operator”, “iButton ID”, “Odometer”, “GSM Signal”, “Deep Sleep”, “Cell ID”, “Area Code”, “PCB Temperature”, “Dallas temperature Sensor 0..2”, “Fuel Counter” and “RFID ID” cannot use Averaging constant functionality.

6.3.1.6 Configurable parameter values and Global parameter values

6.3.1.6.1 Configurable parameters

Table 25 Configurable parameter values

Parameter	ID	Parameter value				Value type
		MIN	MAX	Default	Recommended	
System parameters (chapter 6.3.1.1)						
Sleep Mode (0 – disable, 1 – enable, 2 – Deep Sleep)	000	0	2	0	-	U8
Data Acquisition parameters (chapter 9)						
Min Period (in seconds)	011	0	9999999	600	-	U32
Min Distance (in meters)	012	0	1000000	0	-	U32
Min Angle (in degrees)	013	0	360	0	-	U16
Min Saved Records	014	1	25	10	1	U8
Min Send Period (in seconds)	015	0	9999999	600	-	U32
GPRS Week Time	016	-	-	-	-	-
Geofencing parameters (chapter 6.3.1.3.4.1)						
Frame Border (in meters)	020	0	9999999	1	1000	U32

Zone #1 Shape	030	0 (Circle)	1 (Rectangle)	0	-	U32
Zone #1 Priority (0 – Low, 1 – High, 2 – Panic, 4, 5, 6, 7 – SW21, SW22, SW23, SW24)	031	0	7 (exl. 3)	0	-	U8
Zone #1 Generate Event (0 – no event, 1 – on enter, 2 – on exit, 3 – on both)	032	0	3	0	-	U8
Zone #1 Longitude X1 (Rectangle) / X (Circle)	033	-180	180	0	-	Float
		-180	180	0	-	Float
Zone #1 Latitude Y1 (Rectangle) / Y (Circle)	034	-90	90	0	-	Float
		-90	90	0	-	Float
Zone #1 Longitude X2 (Rectangle) / R (Circle)	035	-180	180	0	-	Float
		0	9999999.99	0	0	Float
Zone #1 Latitude Y2 (Rectangle) / None (Circle)	036	-90	90	0	-	Float
		-	-	-	-	-
AutoGeofencing parameters (chapter 6.3.1.3.4.2)						
Deactivate By	290	0 (Ignition)	1 (iButton)	0	-	U8
Enable/Disable	291	0 (Disable)	1 (Enable)	0	1	U8
Activation Timeout (in seconds)	292	0	65536	60	60	U16
Priority (0 – Low, 1 – High, 2 – Panic, 4, 5, 6, 7 – SW21, SW22, SW23, SW24)	293	0	7 (exl. 3)	1	1	U8
Event Generating (0 – no event, 1 – on enter, 2 – on exit, 3 – on both)	294	0	3	0	2	U8
Radius (in meters)	295	0	9999999	100	100	U32
iButton List (chapter 6.3.1.3.5)						
Authorized iButtons	710-759	0	FFFFFFFF FFFFFFFF		-	U64
Features parameters (chapter 5.7)						
Digital Output No.1 Usage Scenarios (0 – disable, 1 – Eco Driving, 2 – OverSpeeding)	910	0	2	0	-	U8
Max Allowed Speed	911	0	350	90	-	U16
Max Acceleration Force	912	0.5 (5)	10.0 (100)	22	25	Float
Max Braking Force	913	0.5 (5)	10.0 (100)	25	35	Float

Max Cornering Force	914	0.5 (5)	10.0 (100)	21	-	Float
Acceleration Detection Sensitivity	915	0.25 (6)	1.25 (32)	12	-	-
Breaking Detection Sensitivity	916	0.25 (6)	1.25 (32)	12	-	-
Cornering Detection Sensitivity	917	0.25 (6)	1.25 (32)	12	-	-
Acceleration Active Output Duration	918	0	255	60	-	-
Breaking Active Output Duration	919	0	255	60	-	-
Cornering Active Output Duration	920	0	255	60	-	-
Digital Output No.2 usage scenarios	921	0	2	0	-	U8
Trip Start/Stop Detection (0 – disable, 1 – enable)	280	0	1	1	-	U8
Start Speed	281	0	255	5	-	U8
Ignition Off Timeout	282	0	65536	60	-	U16
Trip Continuous Distance Counting (0 – not, 1 – continuous)	283	0	1	0	-	U8
CAN						
Type (0 – standard ID, 1 – extended ID)	770	0	1	0	-	-
Output mask	771	1 byte hexadecimal number	1 byte hexadecimal number	0	-	-
CAN ID	772	4 byte hexadecimal number	4 byte hexadecimal number	0	-	-
GSM parameters (chapter 6.3.1.2)						
GPRS Content Activation (0 – disable, 1 – enable)	240	0	1	0	-	S8
Domain	245	Empty	56 char	Empty	-	-
Target Server Port	246	0	65536	0	-	U16
Protocol (0 – TCP, 1 – UDP)	247	0	1	0	-	U8
SMS data sending settings (0 – disable, 1 – enable)	250	0	1	0	-	S8
SMS Login	252	Empty	5 char	Empty	-	S8[5]
SMS Password	253	Empty	5 char	Empty	-	S8[5]
Authorized phone numbers	260-269	Empty	16 char	Empty	-	S8[17]

Operator Code	271	0	99999999	0	-	U32
SMS Data send week time schedule	273	Binary decoding	Binary decoding	-	-	20 byte array

6.3.1.6.2 Global parameters

Table 26 Global parameters values

Parameter	ID	Possible Parameter Value	Default Value
Profile Change On	100	0/1/2 (0 – 1 SIM Operato List, 1 – 1 SIM On Event, 2 – 2 SIM Operator List)	0
Microphone Level	101	0 – 14 (14 – highest)	10
Speaker Level	102	0 – 100 (100 – highest)	20
Call Number	103	Up To 16 Char	Empty
Call Trigger	104	0/2/3/4 (0 – disabled, 2,3,4 – DIN2, DIN3, DIN4)	0
Analog Input 1-2 Type	105	0/1 (0 – 10 V, 1 – 30 V)	0
Analog Input 3-4 Type	106	0/1 (0 – 10 V, 1 – 30 V)	0
Static Navigation On/Off	107	0/1 (0 – disable, 1 – enable)	1
Records Sorting	108	0/1 (0 – from newest, 1 – from oldest)	0
Active Data Link Timeout	109	5 – 259200 (time in seconds)	5
Ringtone Parameter	110	1 – 10 (number = corresponding ringtone)	1
Accelerometer Filter Start Value	112	1 – 9999 (time in seconds)	1
Accelerometer Filter Stop Value	113	1 – 9999 (time in seconds)	200
Continious Odometer	114	0/1 (0 – disable, 1 – enable)	0
Odometer Start Value	115	0 – 4294967295	0
GNSS Satellite System	116	0/1/2/3/4 (0 – all available, 1 – GPS, 2 – GLONASS, 3 – GNSS (all available) + SBAS, 4 – GPS + SBAS)	0
Garmin Ping	117	0/1 (0 – disable, 1 – enable)	0
Garmin Unicode	118	0/1 (0 – disable, 1 – enable)	1
COM1 Baudrate	119	9600 – 256000	115200
COM1 Mode	120	0 – 255 (5 - Silent, 13 - FM Log, 97 - LLS, 98 - LCD, 99 - RFID, 100 - RFID M7, 101 - Garmin, 161 - COM TCP Link, 177 - COM TCP Link (binary), 201-203 - Reserved 1-4)	0
COM2 Baudrate	122	9600 – 256000	115200
COM2 Parity	123	0/1/2 (0 – none, 1 – even, 2 – odd)	0
COM2 Mode	124	0 – 255 (5 - Silent, 13 - FM Log, 14 – CAN Sniff, 15 – NMEA, 16 – Acceleometer Log, 97 - LLS, 98 - LCD, 99 - RFID, 100 - RFID M7, 101 - Garmin, 161 - COM TCP Link, 177 - COM TCP Link (binary), 201-203 - Reserved 1-4)	0

COM2 Binary TMO	126	1 – 255	10
COM2 Prefix1	127	0 – 255	0
COM2 Prefix2	128	0 – 255	0
COM2 Prefix3	129	0 – 255	0
Auto Answer	130	1 – 10 (number of rings)	3
Temp Sensor 0 ID	140	Up To 16 Char (FW)	0
Temp Sensor 1 ID	141	Up To 16 Char (FW)	0
Temp Sensor 2 ID	142	Up To 16 Char (FW)	0
Network Ping Timeout	155	0 – 30 (time in minutes)	5
Multipacket	156	[0/1]	1
150000 records mode	157	[1,255]	255
RS485 Activate	158	[0,1]	0
RS485 Baudrate	159	[9600,115200]	115200
RS485 Mode	160	[0,255]	5
RS485 Reserved1	161	[0,255]	0
RS485 Reserved2	162	[0,255]	0
RS485 Reserved3	163	[0,255]	0
RS485 Reserved4	164	[0,255]	0
SIM1 GPRS APN	165	all char range	-
SIM1 GPRS USER	166	all char range	-
SIM1 GPRS PASS	167	all char range	-
SIM2 GPRS APN	168	all char range	-
SIM2 GPRS USER	169	all char range	-
SIM2 GPRS PASS	170	all char range	-

6.4 Read Records

FM5500 supports two records sizes mode: 64 Bytes and 256 Bytes. In 64 Bytes Mode there can be less IO elements activated. Combined with 128 Mbit flash these characteristics are maintained:

Record Size	Flash Size + Max records	Time needed to fill memory
256	128 Mbit + 47616	50 days
64	128 Mbit + 190464	200 days

Calculations are based on these settings:

- MinPeriod 10 minutes,
- Min Distance 1000m,
- 8 hour woking day with average of 80 km/h,
- 50 recods a day average.

When the FM5500 is working in offline mode, it saves records. Since these records are not sent to the server, they can be downloaded directly to computer using USB connection. When FM5500 connected to configurator appears additional option “Read Records” (Figure 30).

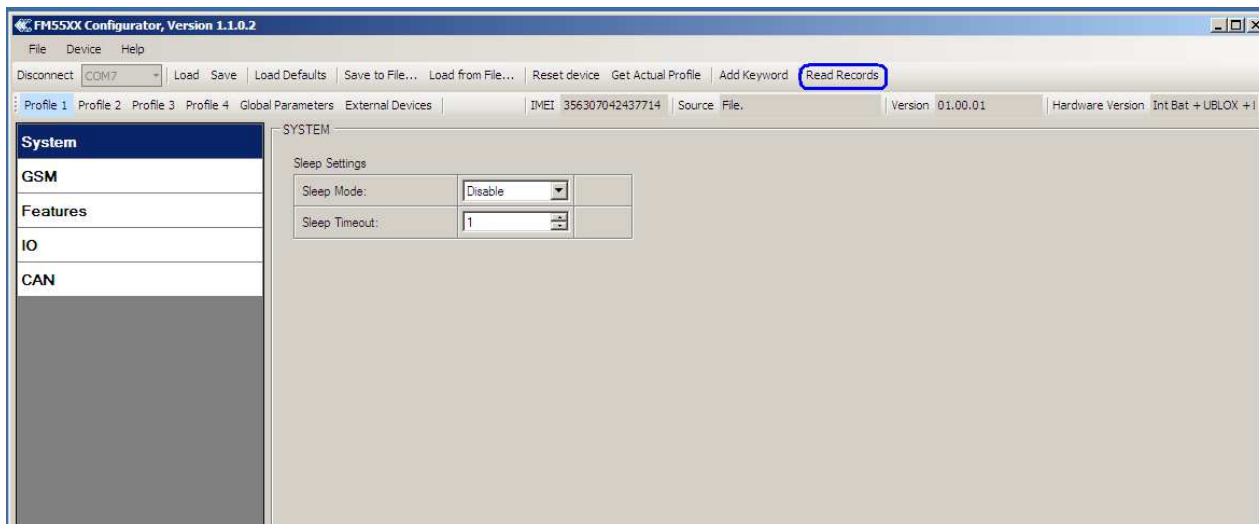

Figure 32 FM55XX Configurator window with FM5500 connected

After device is switched on, you have to wait 3 minutes for device to startup. Only then it is possible to download records. If the memory is full, reading may take several minutes. All records are deleted from device’s memory after reading. Data is stored in a binary file on PC. Records could be uploaded from file to TAVL server and access all the data from TAVL application.

TAVL client application lets user to use the following features:

- Import data file saved from the device to the TAVL;
- Preview track of the imported data;
- Generate reports based on imported data.

More details on how to use TAVL application please refer to “TAVL3 application user manual v1.4” documentation or its latest versions.

Note that FM55500 can have memory full of records. In such a case it will start deleting oldest records in order to save new ones. Sending all the data records to server may take some time.

Record size is selected by choosing the RecSize Settings in the Global Parameters tab of the configurator (please see Figure 33 below).

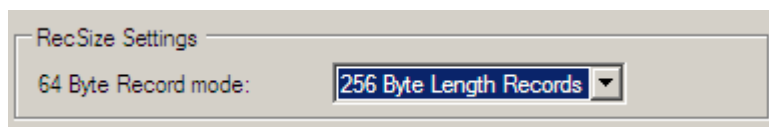

Figure 33 RecSize settings, 256 Byte Length Records mode

When the 256 Byte length Records mode is chosen FM5500 can save up to 47.000 records. Record size is 256 bytes.

When 64 Byte Length Records mode is chosen (please see Figure 34 below) all existing records will be deleted.

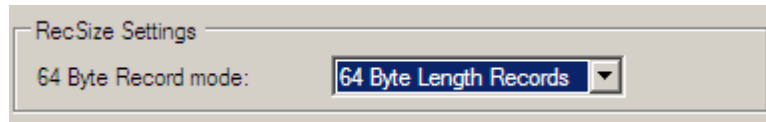

Figure 34 64 Byte Length Records mode

Before deleting the records, the Warning window will show up to inform that after pressing „Yes“ button, all the records will be deleted from memory and all IO Elements will be disabled (please see Figure 35 below):

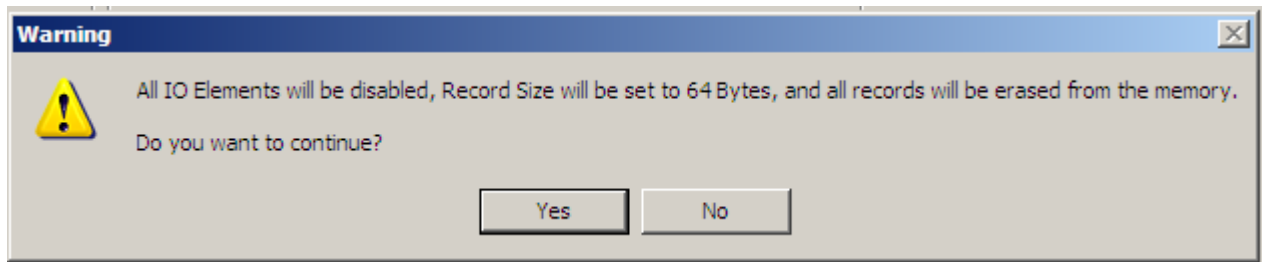

Figure 35 Warning window when changing RecSize Settings

When switching from 64 Byte Length Records mode to 256 Byte Length Records mode, the IO elements are not disabled, but the memory is fully formatted and all the records in memory will be lost. So when configuring device you must make sure that you don't accidentally switch these modes. Available record size limits are shown in IO configuration menu of all profiles (please see Figure 36 below):

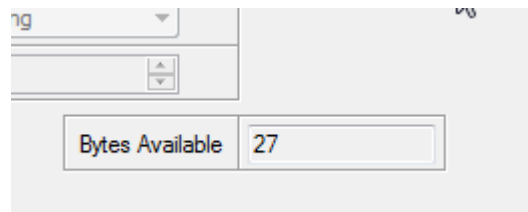

Figure 36 Available record size in IO configuration menu

7 PROFILE SWITCHING IN 1 SIM OPERATION MODE

FM5500 has 4 profiles saved in Flash memory of the module. Every profile has a list of parameters, which enables FM5500 to operate in different modes while using different profiles. The easiest way to understand what is a profile is to compare it to a list of instructions that are written for different cases. You are allowed to setup up to 4 different module behaviours. Global parameters contain settings that are common for all 4 profiles. This means that if you set FM5500 to call to a predefined number, you will be able to call it while using any profile. Basic scheme of Global parameters and profiles is shown below. According to the scheme, every profile has a list of parameters. Global parameters are common for all profiles. (Figure 3644)

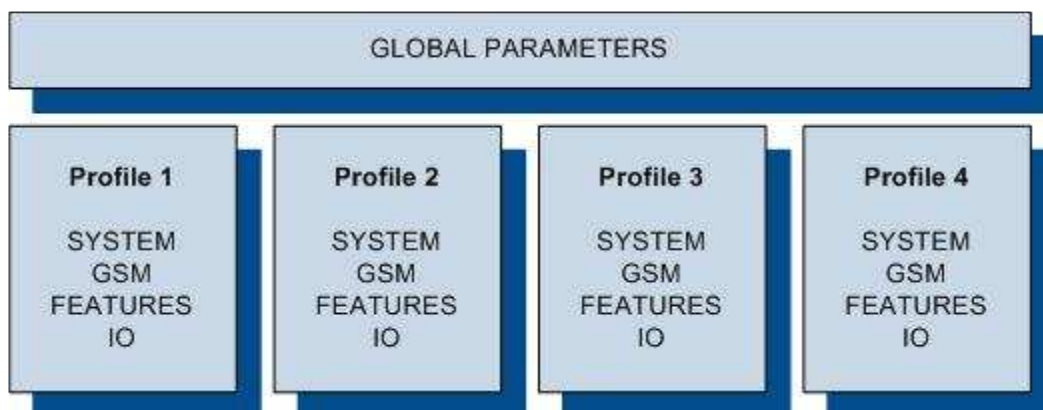

Figure 364 FM5500 profile structure

Switching between profiles (changing behaviour) can be performed by Profile switch depending on GSM operator code (mostly used for roaming applications), or by Profile switch depending on I/O event (on I/O value changing).



Profile 3 is default profile for FM5500. It is always loaded on the very first start-up and further profile switching is proceeded after operator scan or I/O element changes (although device remembers which profile it used after that).

7.1 Profile Switching dependence on GSM Operator

GSM Operator code profile switching is mostly used in roaming applications, when the purpose is to have information from module both from Home and Roaming operator network for a reasonable price. This method allows you to define different module behaviour in Home network, Roaming network and unknown operator areas. See figure below for details.

Profile 1 is configured for home network. Data acquisition and send intervals are quite frequent here. To make profile use effective, it is wise to set more optimized parameters in roaming profile (Profile 2) – this usually includes larger coordinate recording intervals, packets with greater number of coordinates sending, and in some cases GPRS context available only for a certain time interval. Profile 3 can either contain operator codes (rarely used) or have an empty

list. Profile 4 is not used (profile 4 can only be used when FM5500 encounters a 'panic' priority event (see 7.2 chapter)).

In the example (Figure) FM5500 connects to operator with code 24702. It checks profile 1 operator list, but there is only one operator code entered which does not match. Then it checks profile 2 operators list. This code is entered there, so FM5500 switches to profile 2.

If there are no operator codes entered in all profiles after operator search task FM5500 will check all 3 profiles and won't find any operators in any list. In such a case, FM5500 will switch to profile 3. Note that before switching to profile 3, the device closes the GPRS session.



Operator search is performed every 15 minutes. If no operators are entered in any profile it can have influence on GPRS sessions. IF GPRS sessions are attaching/detaching every 15 minutes it means configuration of FM5500 is performed incorrectly.

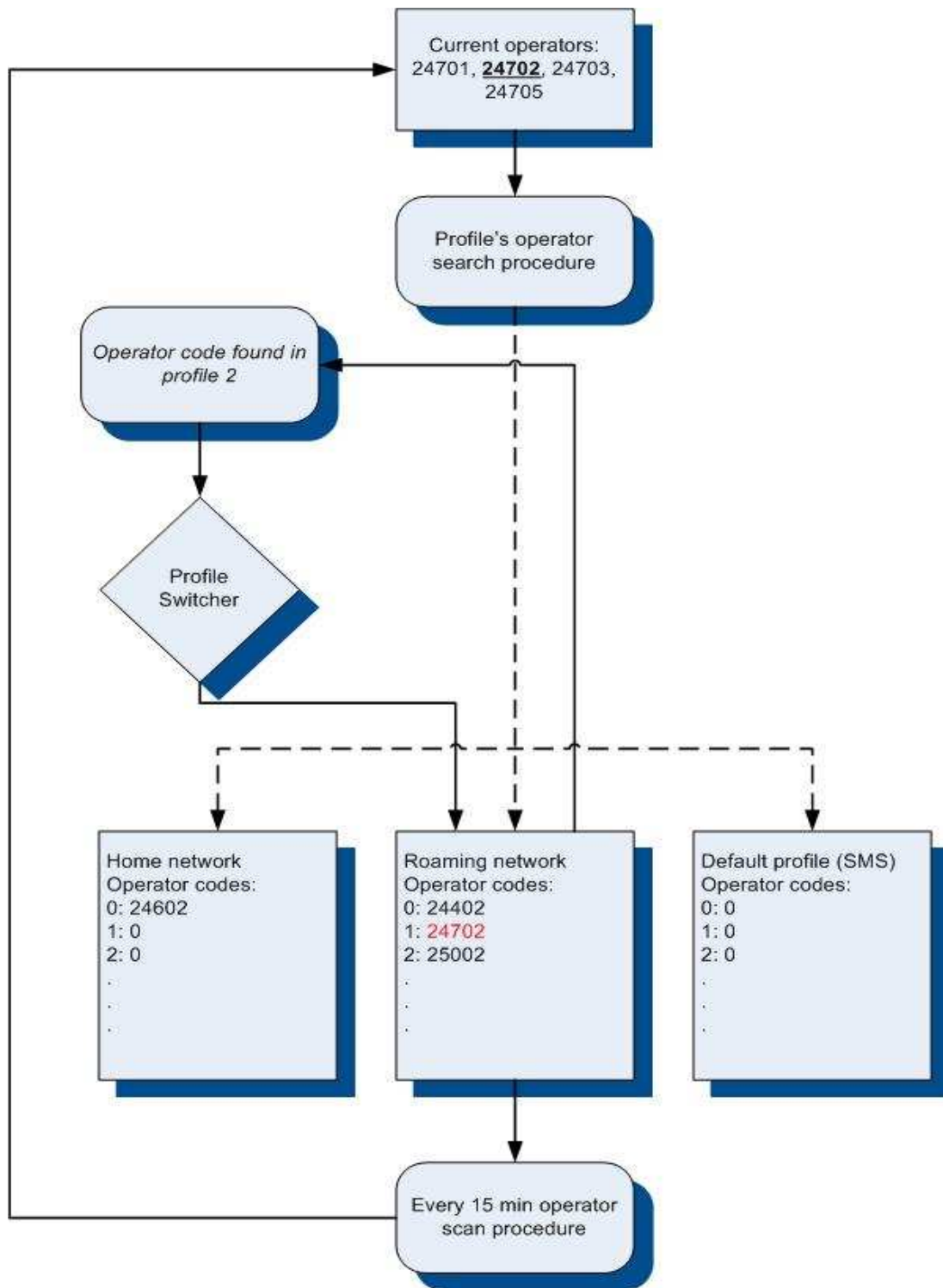

Figure 45 GSM Operator code profile switching (...)

7.2 Profile switching dependence on I/O event

Another profile switch method is based on I/O event. Events happen when the value of enabled I/O intersects thresholds (enter, exit, on both, hysteresis) predefined by High and Low

level thresholds. SW21, SW22, SW23, SW24 stands for “Switch to profile No. X”. After an event happens, FM5500 switches to a defined profile. Using profile switching you can create smart applications. SW2X actions can be performed only if “Profile change on event” is enabled in Global parameters. Pictures below illustrate profile switching depending on digital events:

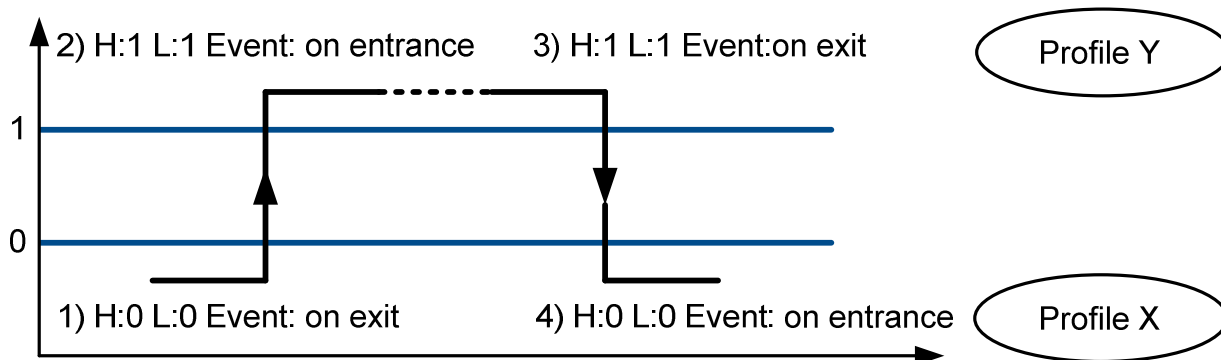

Figure 46 Digital input event criteria

Example #1

Configuration of Profile1 to switch to Profile2 on DIN1 value change from 0 to 1:

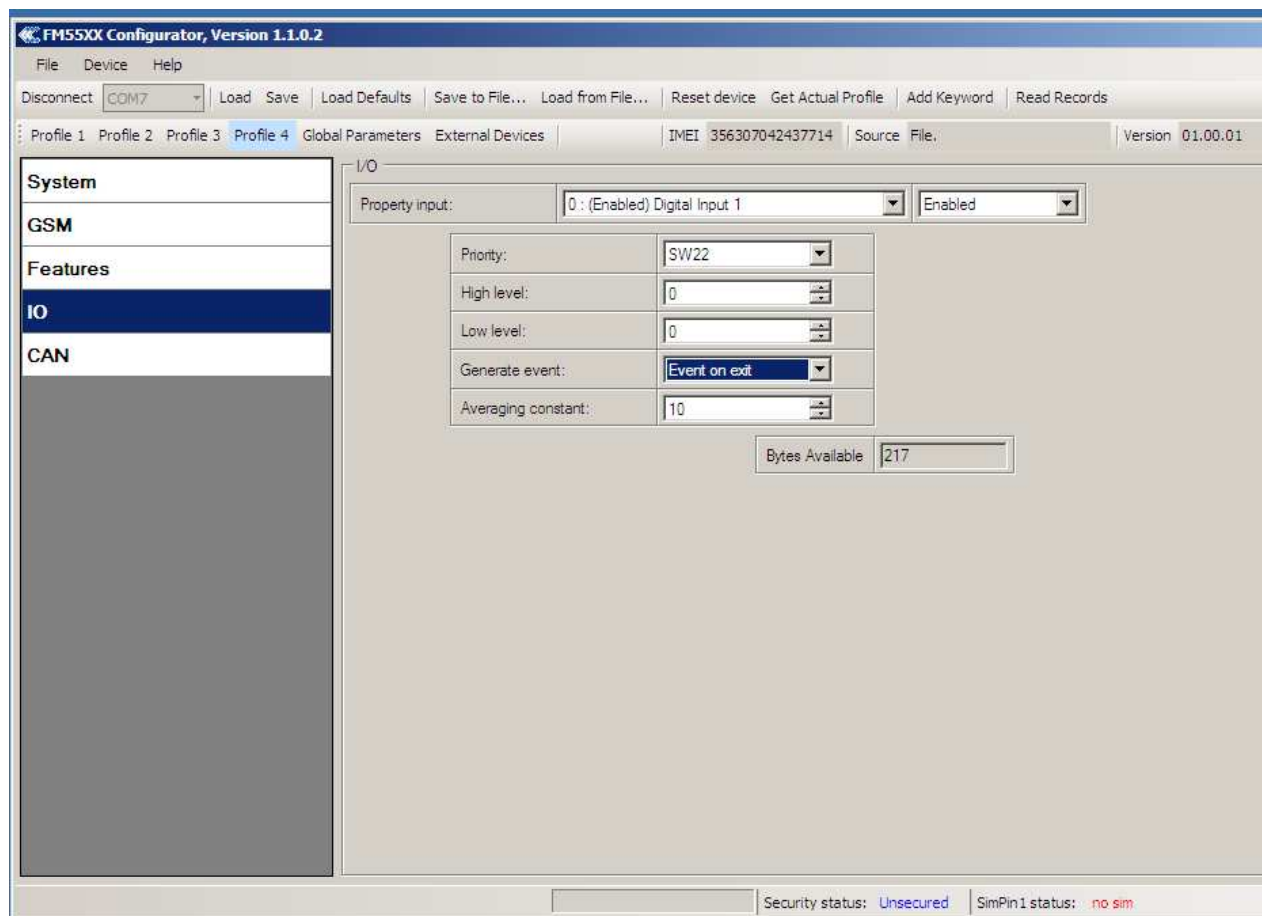

Figure 37 Switch to profile on event (1)

Example #2

Configuration of Profile2 to switch to Profile1 on DIN1 value change from 1 to 0:

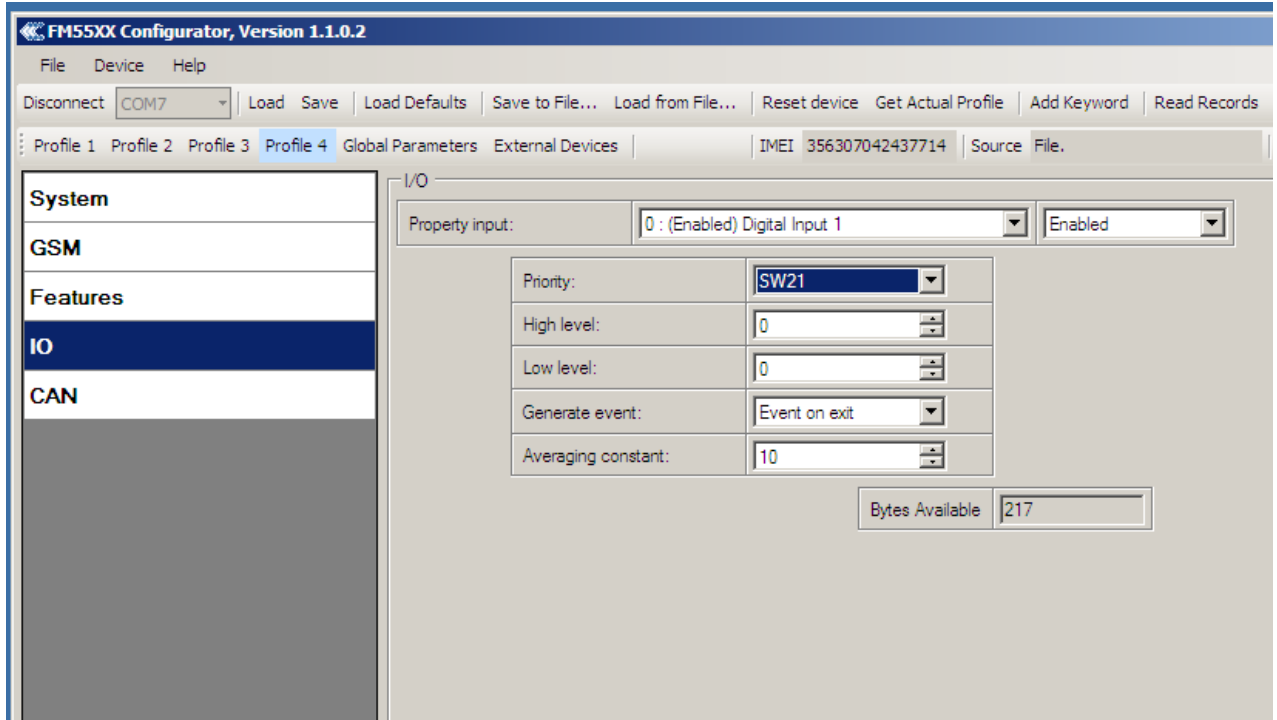

Figure 48 Switch to profile on event (2)

8 DUAL SIM FUNCTIONALITY

FM5500 is able to operate in DUAL SIM switching mode to minimize the bill accounts for GSM/GPRS services. To use this mode, 2 SIM Operator list enumerated value must be chosen for Profile Change On setting in Global parameters tab after FM5500 is connected to configurator (shown in Figure 37).

When DUAL SIM operating mode is set: profile 1 becomes Home, profile 2 becomes SIM 1 Roaming, profile 3 becomes SIM 2 Roaming and profile 4 becomes Unknown Operator. In this chapter the operation and configuration of DUAL SIM mode is presented.

FM5500 can be used with one SIM. SIM1 card has higher priority than SIM2. For one SIM card using it must be placed in SIM1 slot for FM5500 to switch minimum times.

If SIM card is inserted into SIM 2 slot and 1 SIM operator list mode is used, FM5500 will work normally, but there will be more switching activities. In addition, APN settings in Global parameters should be entered for SIM 1 and SIM 2 to avoid not sending records over GPRS.

When FM5500 connected to configurator choose Global Parameter section as shown on Figure 37 FM55XX Configurator window 2SIM mode setup, then in Profile Change ON select 2 SIM Operator List.

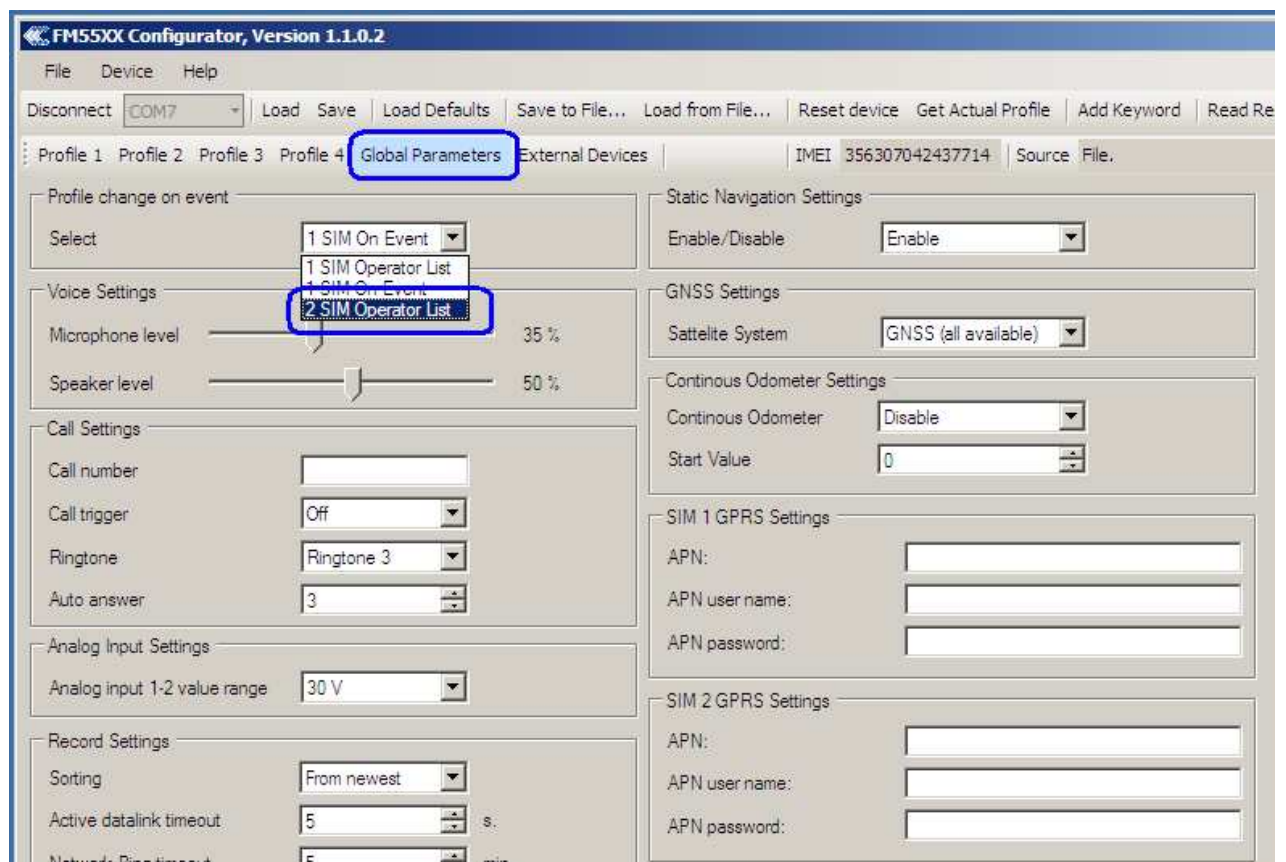
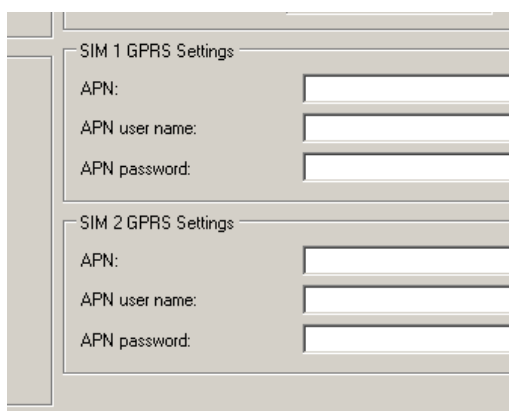

Figure 37 FM55XX Configurator window 2SIM mode setup

You can see four profiles buttons: Home, SIM 1 Roaming, SIM 2 Roaming and Unknown Operator.

SIM 1 and SIM 2 APN settings are set in the Global parameters tab (Figure 8). Some operators use specific authentication for GPRS session – CHAP or PAP. If any of these is used, APN should be entered as 'chap:<APN>' or 'pap:<APN>'. I.e. if operator is using APN 'internet' with CHAP authentication, it should be entered as 'chap:internet'. Information about APN and authentication type should be provided by your GSM operator.



SIM 1 GPRS Settings	
APN:	<input type="text"/>
APN user name:	<input type="text"/>
APN password:	<input type="text"/>

SIM 2 GPRS Settings	
APN:	<input type="text"/>
APN user name:	<input type="text"/>
APN password:	<input type="text"/>

Figure 38 APN settings for SIM 1 and SIM 2

Home Network

Selecting Home profile gives Home Operator Code settings possibility for SIM 1 and for SIM 2 (Figure 39). These Home Operators have the highest priority and must be inserted. FM5500 gets possible operator codes list from the network and compares them with the operator codes inserted in Home profile's list. At first, it tries to connect to SIM 1 Home Operator, if operator is unreachable, the device switches to SIM 2 slot and tries to connect to SIM 2 Home Operator.

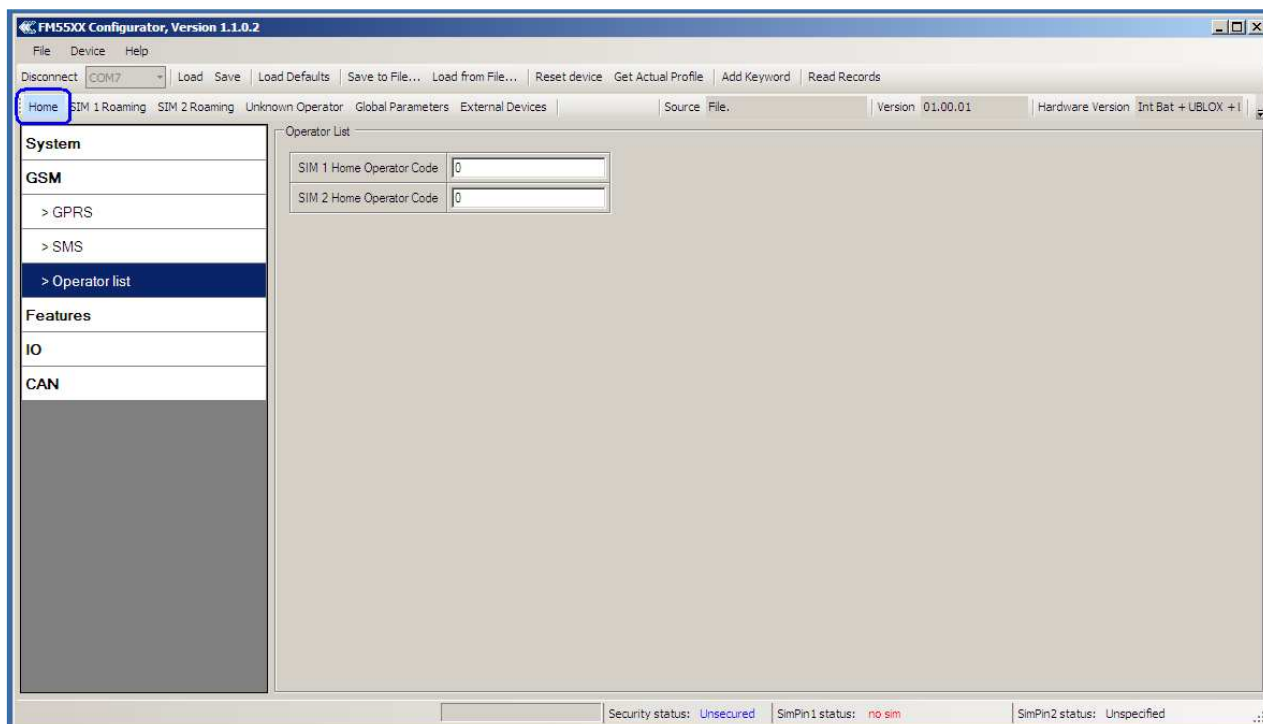

Figure 39 Home network setting

When the connection procedure is successful, FM5500 stays connected to the available Home operator using the SIM card, which was inserted for and works according to the Home profile parameter settings.

If none of the Home operators could be connected with, FM5500 switches to the SIM 1 card tries to connected to its roaming operators from SIM 1 Roaming profile.

SIM 1 Roaming

In this window you can fill the Preferred Operators List for SIM 1, up to 50 operators (Figure 40 SIM 1 Roaming Operator list40). SIM 1 Roaming operator list has the second priority after the Home operators. If there are no available home operators, FM5500 checks if there are available SIM 1 Roaming operators from the list. If there are several available Roaming operators from the list, FM5500 connect to the higher priority operator from the SIM 1 Roaming operator list.

If there are no available operators from SIM 1 Operator list or the list is empty, FM5500 scans the SIM 2 Roaming operator list for available operators.

If the connection is lost, FM5500 will return to Home profile and try to connect to Home operators as it has higher priority. FM5500 checks a possibility to connect to Home network every 10 min. and goes further by priority.

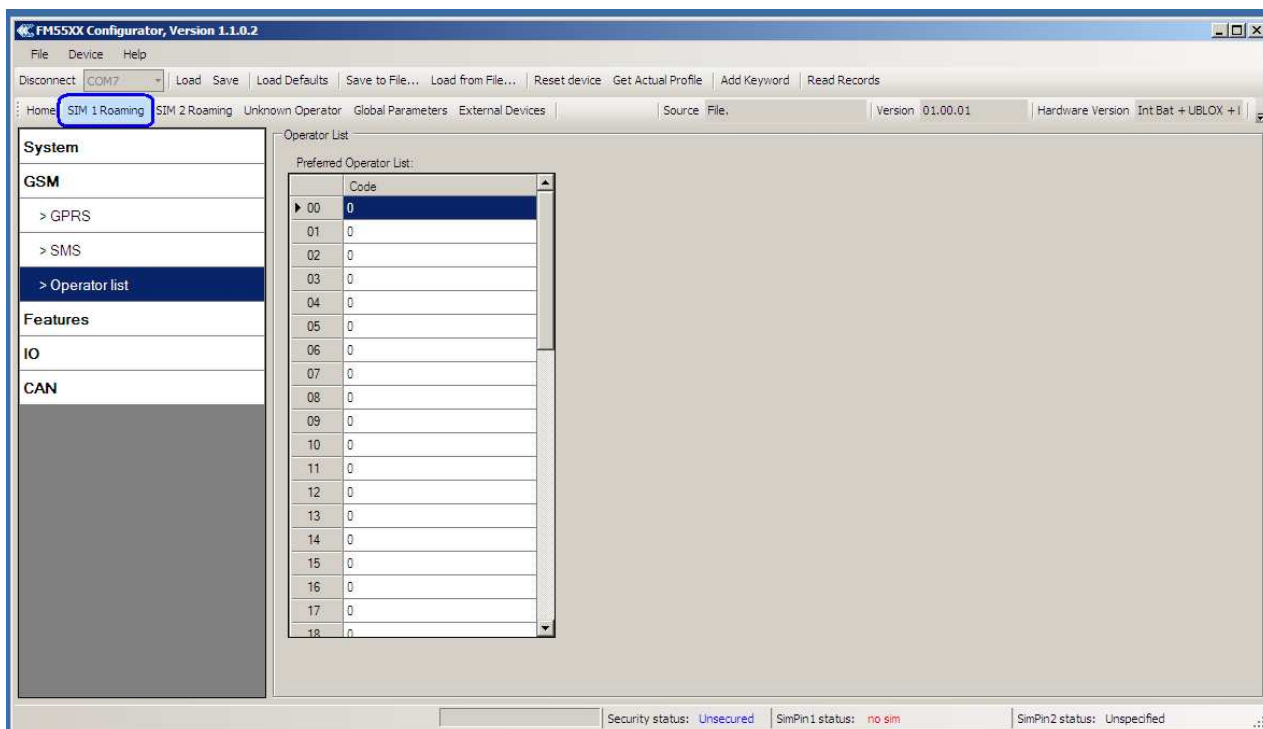

Figure 40 SIM 1 Roaming Operator list

SIM 2 Roaming

In this window you can fill the Preferred Operators List for SIM 2 up to 50 operators (Figure 40 SIM 1 Roaming Operator list41). SIM 2 Roaming operators list has the third priority after the Home network and after SIM 1 Roaming operators list. If there are no available operators from Home operator list and SIM 1 Roaming operators list, FM5500 scans for available operator in the SIM 2 Roaming operator list. If there is an available SIM 2 Roaming operator in the list, FM5500 switches the profile to SIM 2 Roaming, switches the SIM card to Slot 2 and connects to available operator from the SIM 2 Roaming operator list.

If the connection is lost, FM5500 will return to scan Home network as it has higher priority, after it goes to scan SIM 1 Roaming operators list as it has the second priority, only will be not connections in higher priorities lists it goes to scan SIM 2 Roaming operators list again. FM5500 every 10 min. checks a possibility to Home network connection and further, if it is necessary, operates by the priority.

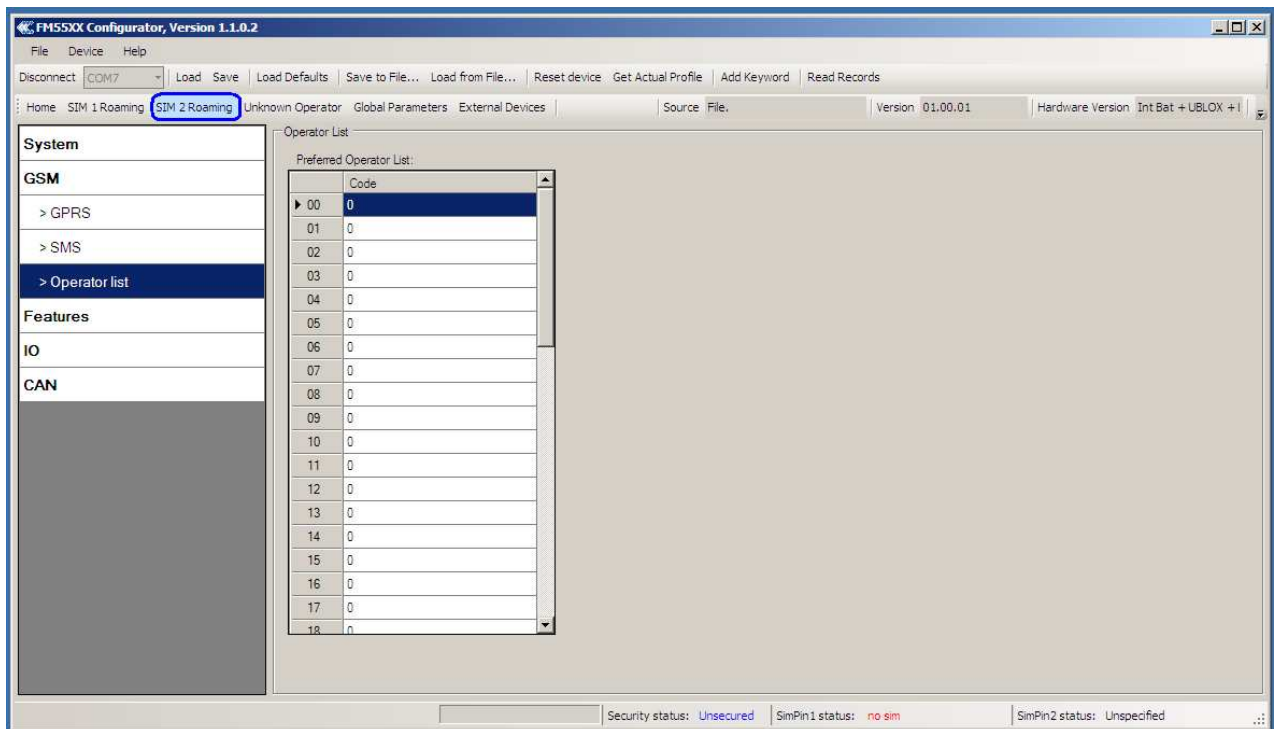

Figure 41 SIM 1 Roaming Operator list

Unknown Operator

Unknown Operator profile (Figure 42) has the forth priority after the Home network, after SIM 1 Roaming operators list and after SIM 2 Roaming operators list. The user cannot insert operators in Unknown operator list, it is not usable.

The FM5500 switches to Unknown operator profile using the SIM card it has used before (FM5500 doesn't switch the SIM cards) when SIM 1 and SIM 2 operator lists are empty and there is no possibility to connect to SIM 1 and SIM 2 Home operators. In this profile FM5500 connects to an operator from the list, received from the network, with the best signal quality.

FM5500 every 10 min. checks a possibility to Home network connection and further, if it is necessary, operates by the priority.

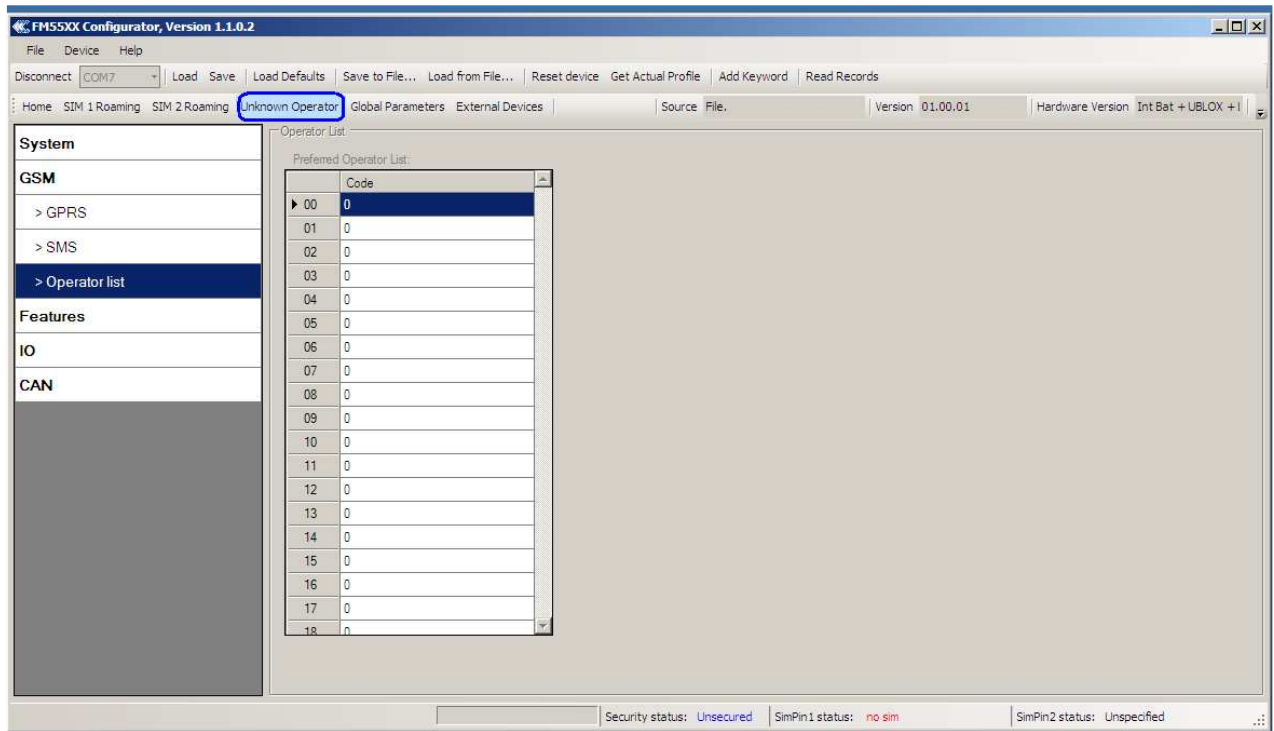

Figure 42 Unknown Operator List

Dual SIM algorithm

Two SIM cards use algorithm is shown in the diagram (Figure 43 Dual SIM connection algorithm).

Dual SIM Algorithm

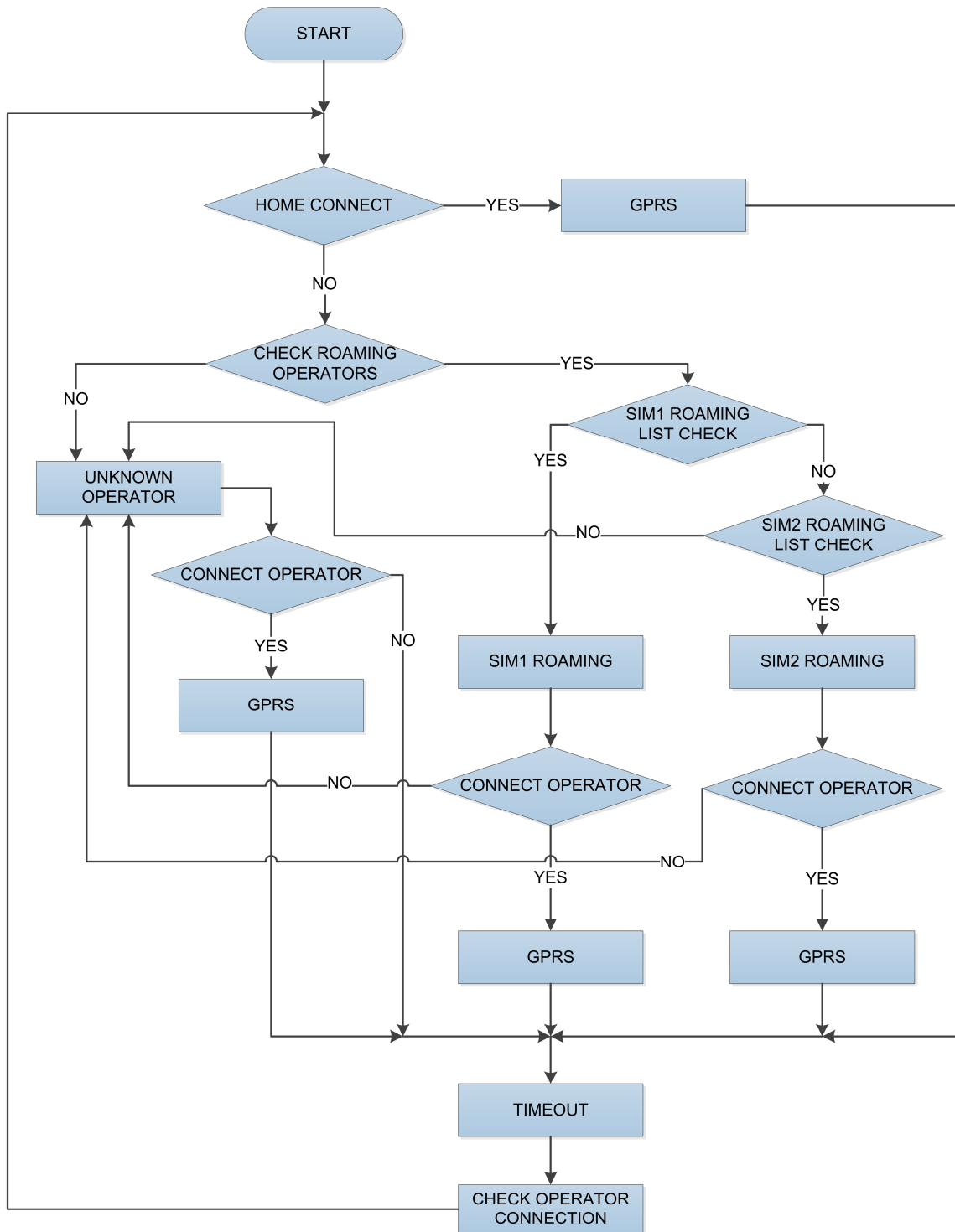

Figure 43 Dual SIM connection algorithm

The FM5500 is always trying to connect to Home operator. If it cannot connect, then it goes to Roaming Operator. The Roaming Operator is chosen by priority. Higher placed operator in the operators list has higher priority. If impossible to connect to Roaming Operator from operator's list or the operators list is empty, then the FM5500 connects to Unknown operator.

In all cases when a timeout has appeared the operator search procedure is done. If better home operator is found or the higher priority operator from the roaming operator list is found, the device connects to it. For example: Home is better than Roaming Operator, Roaming operator is better than Unknown operator. In other cases the primary operator's connection is continued.

9 DATA ACQUISITION

Data can be acquired using GPS or I/O elements. GPS data is for basic vehicle tracking, data acquisition by I/O elements gives more specific information.

9.1 GPS data acquisition

There are three ways of GPS data acquisition which are configured in *Features > sMode* menu (Figure 49).

Device checks angle, distance and time differences with last saved record. If differences are greater than configured a record is generated. Checking sequence: first angle is checked then distance and last - time differences.

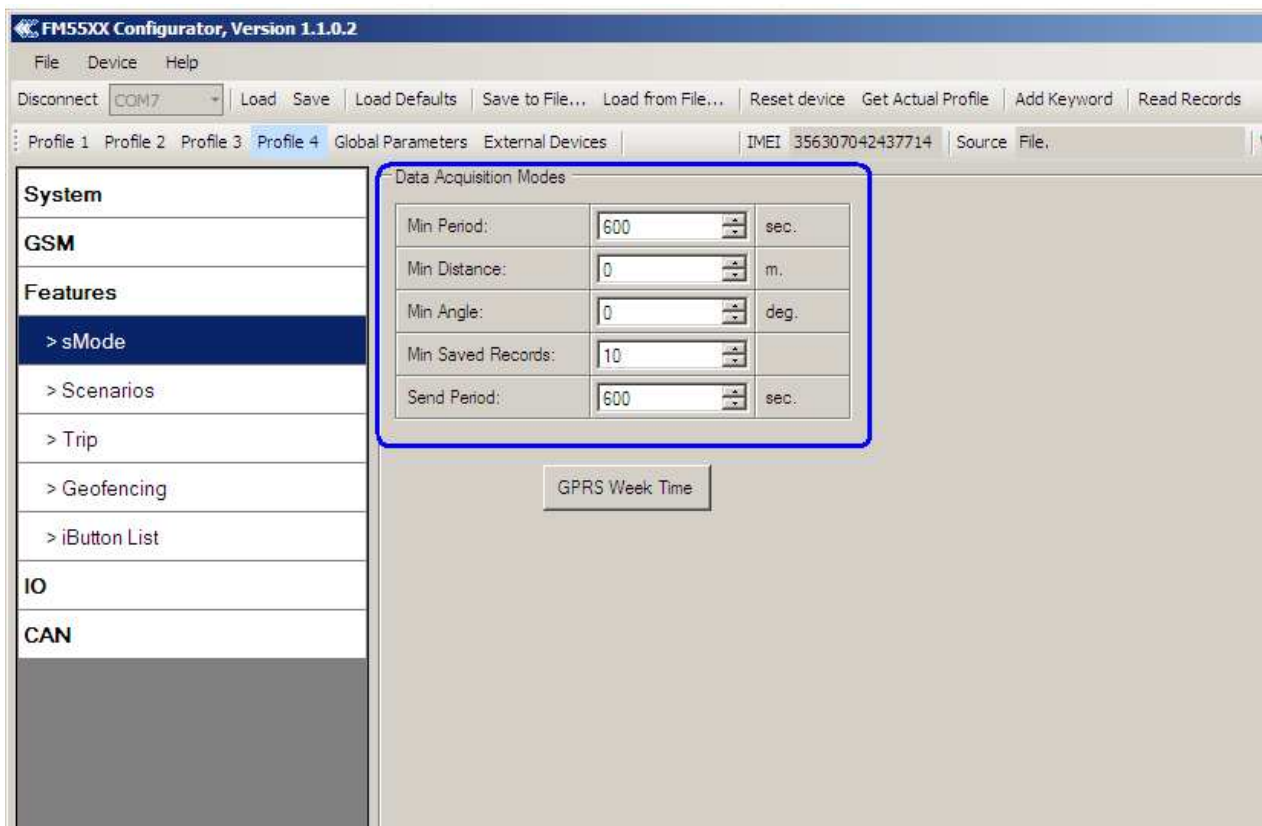

Figure 49 GPS acquisition configuration window

Actual configuration parameters are marked in blue.

Min. Period

Time based data acquiring (Figure 50) – records are being acquired every time when defined interval of time passes. Entering zero means that data will not be recorded according to time. This method is suitable best for basic position update.

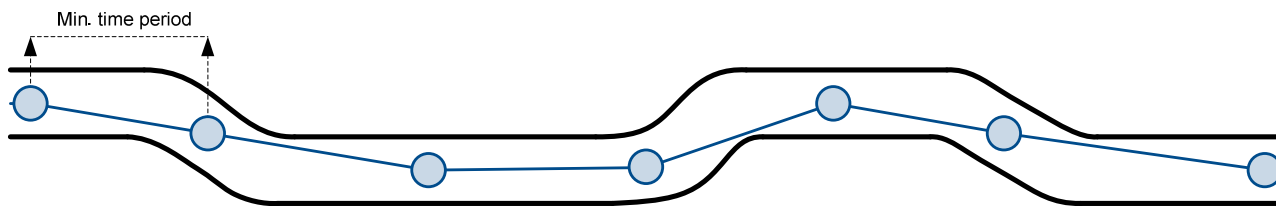

Figure 50 Time based tracking

Min. Distance

Distance based data acquiring (Figure 51) – records are being acquired when the distance between previous coordinate and current position is greater than defined parameter value. Entering zero means that data won't be recorded. This method is suitable for non-urban territories where moving trajectory is straight.

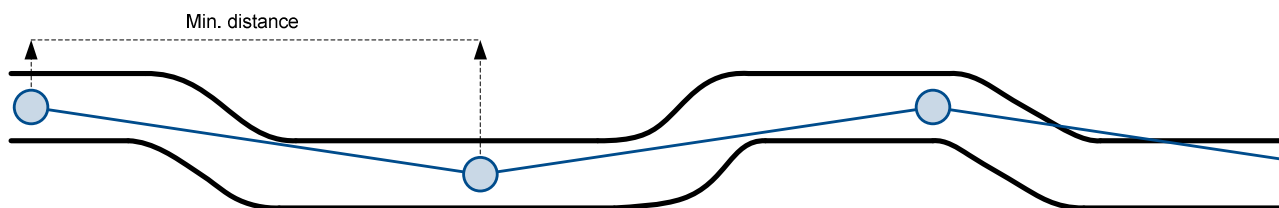

Figure 51 Distance based tracking

Min. Angle

Angle based data acquiring (Figure 52) – records are being acquired when angle difference between last recorded coordinate and current position is greater than the defined value. Entering zero disables data acquisition depending on angle. This method is suitable for urban territories. Note that record generation by angle is performed if vehicle is moving at least 6 km/h.

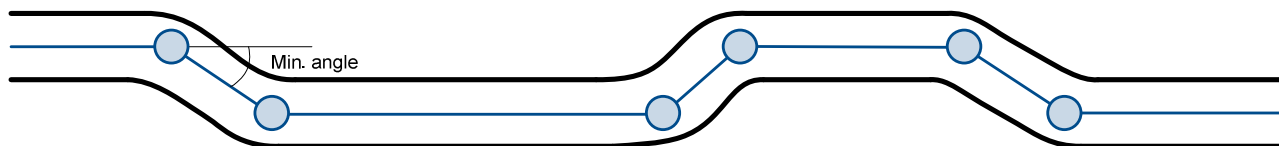

Figure 52 Angle based tracking

9.2 I/O data acquisition

Data also can be acquired using input output elements (it's change). All base elements are declared in Table 9 PERMANENT I/O elements list description and in Table 10 EVENTUAL I/O elements list description

Configuration

Data acquisition by I/O elements can be configured selecting I/O menu in configurator (refer to chapter 6.3.1.4.2).

Priority: Low – as a regular data; High – generated record are sent immediately to server; Panic - generated record are sent immediately to server and simultaneously the same record as SMS message;

High Level: High range of value input;

Low Level: Low Range of value input;

Averaging constant: (see detailed description in chapter 6.3.1.4.2)

Event generation

There are five record event generation type examples (I/O speed is taken as I/O value example), please refer to Figures below.

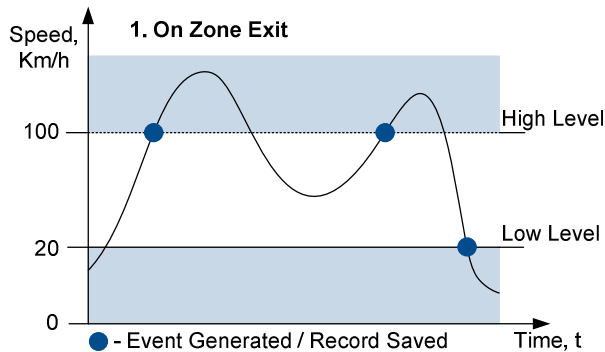

Figure 53 Event On Zone exit

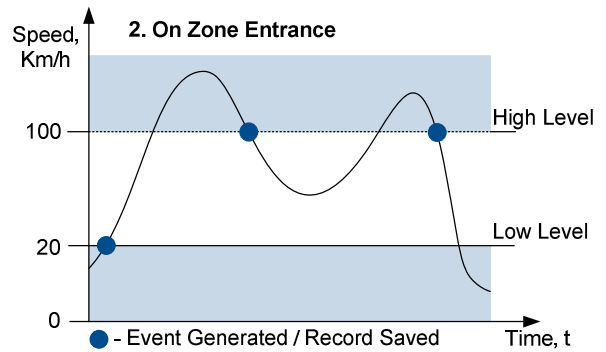

Figure 54 Event On Zone entrance

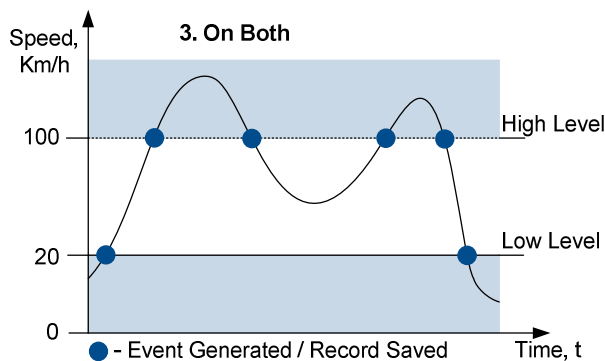

Figure 55 Event On both

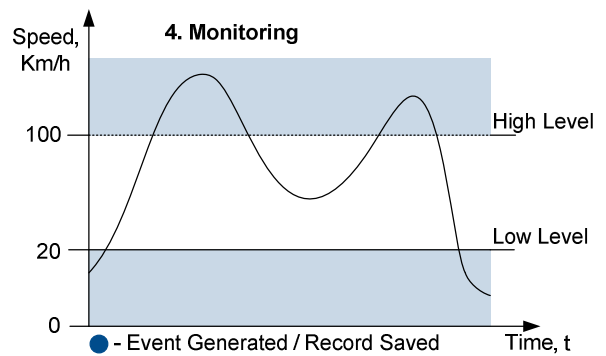

Figure 56 Monitoring

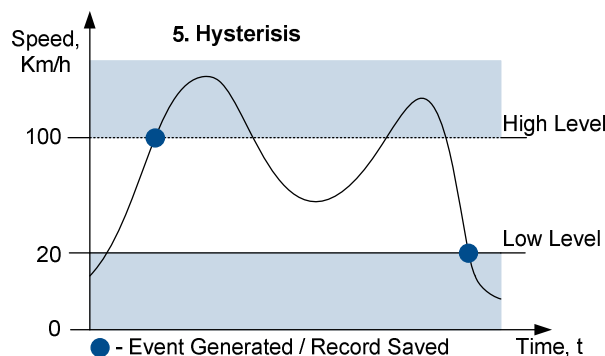

Figure 57 Event on Hysteresis

Event on Zone Entrance: record is generated when actual source value input is between High and Low level ranges which are set in configuration;

Event on Zone Exit: record is generated when actual source value input increases and becomes higher than High level and Low level values;

Event on Both: record is generated when actual source value input increases/decreases and becomes higher/lower than high and low level declared values;

Monitoring: no event at all; I/O values are recorded only when other trigger have worked (GPS acquisition or other I/O trigger)

Hysteresis: record is generated when actual source value input becomes higher than High level value, and decreasing becomes less than Low level value

Event on Change: record is generated on every source value change.

10 SLEEP MODE

While in sleep mode, FM5500 sets GPS receiver to sleep mode but GSM/GPRS module stays active, in Sleep mode power usage can be decreased to save vehicle's battery, because GPS module is turned off.

FM5500 can enter sleep mode if **ALL** of these conditions are met:

- FM5500 has to be configured to work in Sleep mode;
- Start-up timeout has elapsed (5 minutes after every restart of the device);
- No movement by accelerometer is detected;
- Ignition (DIN1) is off (driven logic low);
- USB cable is not connected.

FM5500 exits sleep mode if **ONE** of the following conditions are true:

- Movement by accelerometer is detected (depends on accelerometer start settings);
- Ignition (DIN1) is turned on (driven logic high);
- USB cable is connected;
- HIGH or PANIC priority eventual record is detected;

While being in sleep mode FM5500:

- cannot save periodical or eventual records;
- send data to server;

11 DEEP SLEEP MODE

While in deep sleep mode, FM5500 sets GPS receiver to sleep mode and turns off GSM/GPRS module (it is not possible to wake up device via SMS), therefore records with last good coordinates are being saved and sent to AVL server if configured (GSM/GPRS module is turned on to send data and after turned off). Depending on two configurable parameters, send

period and min period, in Deep Sleep mode power usage can be decreased to save vehicle's battery.

FM5500 can enter deep sleep mode (standby mode) if **ALL** of these conditions are met:

- FM5500 has to be configured to work in Deep Sleep mode;
- Start-up timeout has elapsed (5 minutes after every restart of the device);
- No movement by accelerometer is detected;
- Ignition (DIN1) is off (driven logic low);
- Send period is more than 60 seconds (Data Acquisition Mode settings);
- USB cable is not connected.

FM5500 exits deep sleep mode if **ONE** of the following conditions are true:

- Movement by accelerometer is detected (depends on accelerometer start settings);
- Ignition (DIN1) is turned on (driven logic high);
- USB cable is connected;
- HIGH or PANIC priority eventual record is detected;

While being in deep sleep mode FM5500:

- can save periodical or eventual records;
- send data to server;



Note: If there is no need to save or send periodical data FM5500 has to be configured to switch to another profile on Deep Sleep Event where Min Period and Send Period parameters are 0 or big enough.



Note: In order to save GPRS traffic records saved in deep sleep mode contain below listed I/O elements information:

Digital Inputs (1-4), Analog Inputs (1-4), Battery Voltage, Battery Current, Digital Outputs (1-4), External Voltage, Movement Sensor, Deep Sleep.

Also, Deep Sleep I/O is always LOW PRIORITY!

12 FEATURES AND SCENARIOS

12.1 Eco Driving Scenario

Four scenarios are available on FM5500 device.

Digital Output No.1 is used by scenarios - Eco Driving **or** Over Speeding;

Digital Output No.2 is used by scenarios - Authorized Driving **or** Immobilizer.



Eco Driving Scenario. Helps to prevent and inspect driver about harsh driving. Scenario continuously monitors: accelerating, braking and cornering forces. The device inspects driver if needed. Monitoring sensitivity is configurable.

DOUT1 is controlled by scenario for user needs, buzzer or LED for example. Output activation time after harsh event is also configurable.

To save GPRS traffic Eco Driving event will be **generated (included into records) only** when FM5500 measured values are higher than those set in configuration, without additional I/O settings.

To prevent generating false events, **Eco Driving** functions only when special conditions are fulfilled (mentioned below).



PLEASE NOTE that functionality generally is dependent on accelerometer. Device must be on plain/horizontal surface to calibrate itself correctly. It calibrates once it is powered up.

Mounting Requirements



PLEASE PAY ATTENTION, that ECO driving functionality will operate correctly only if device is mounted into the vehicle in a proper position.

Eco Driving functionality operation is based on accelerometer. It is important to mount FM5500 device correctly to avoid functionality malfunctions (first condition). In the picture below (Figure) mounting recommendations are displayed. Please **note** that beside those recommendations

1. You can choose how FM5500 is deployed. It means that that there is no effect to measurements if FM5500 top/bottom side points up or down.
2. Device can be deployed at any place in the car.

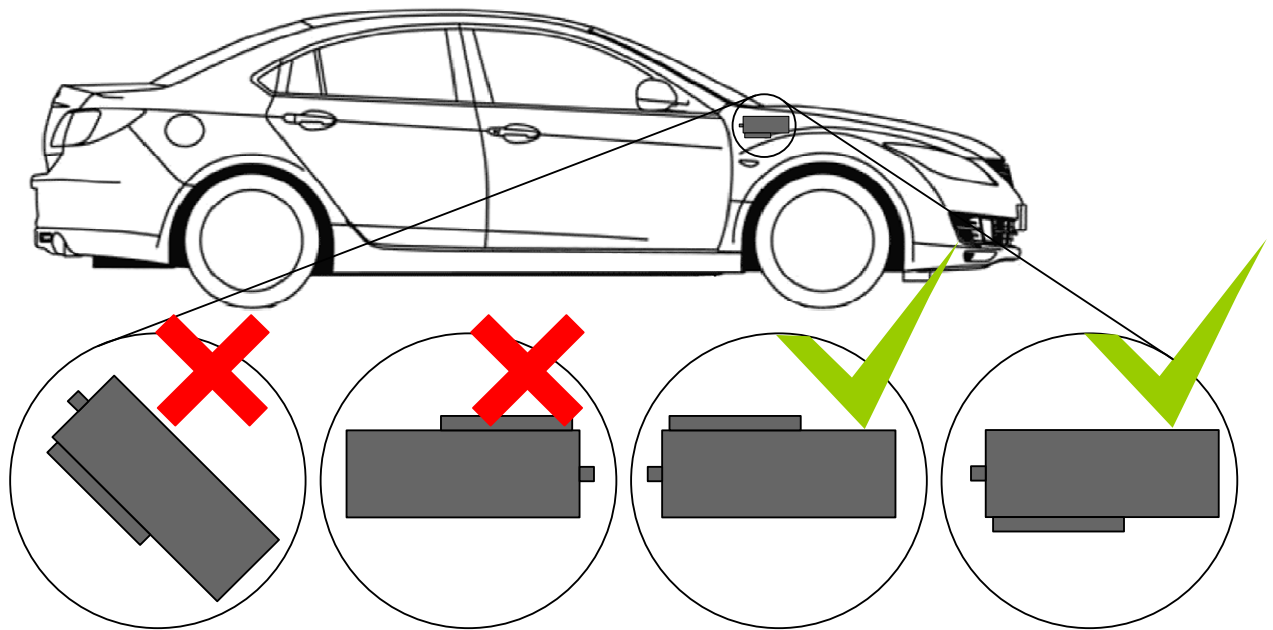

Figure 58 Correct mounting position of the FM5500 in the vehicle

For Eco Driving to work properly, device connection pins socket must point towards the vehicles front side. Deviations of $\pm 2^\circ$ are allowed. But it should be as straight as possible. Deviations of maximum $\pm 15^\circ$ are allowed (Figure 59).

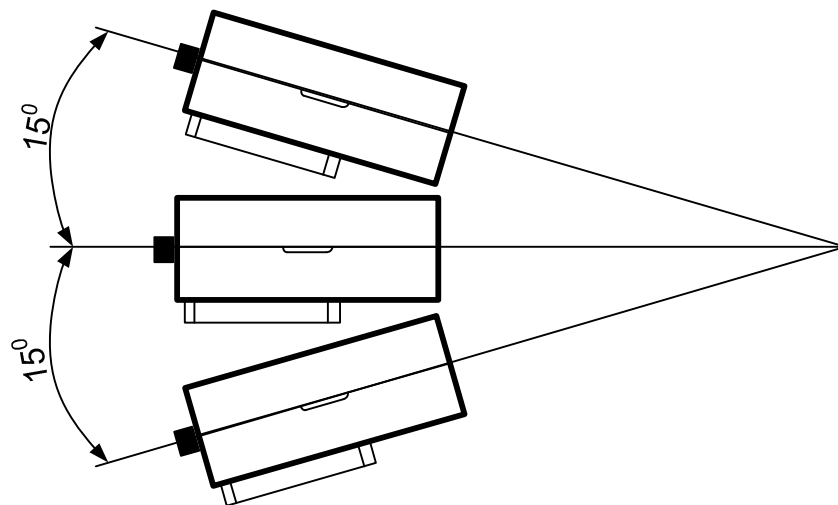

Figure 59 MAX deviation from horizontal plane of FM5500 mounting

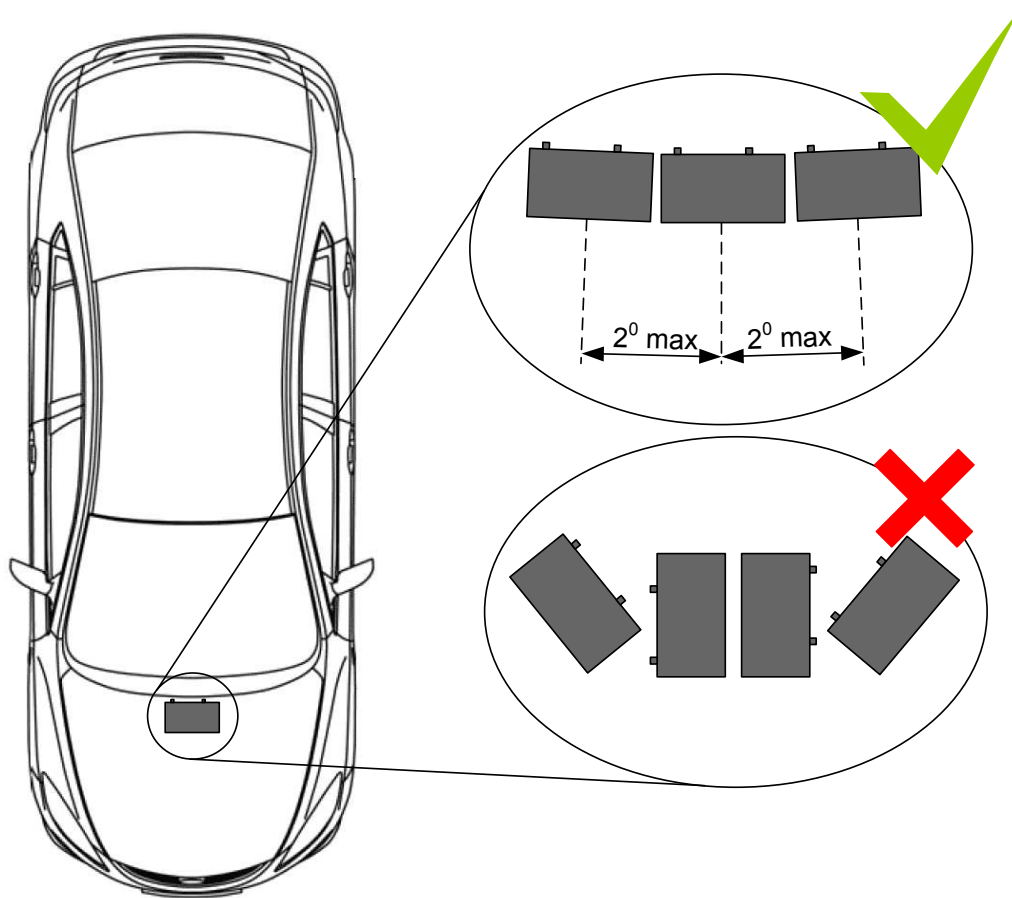

Figure 60 Horizontal position MAX deviation of FM5500 mounting

Horizontal position must be as flat as possible – parallel with vehicle plain.

Configuration

Parameters used with Eco driving functionality.

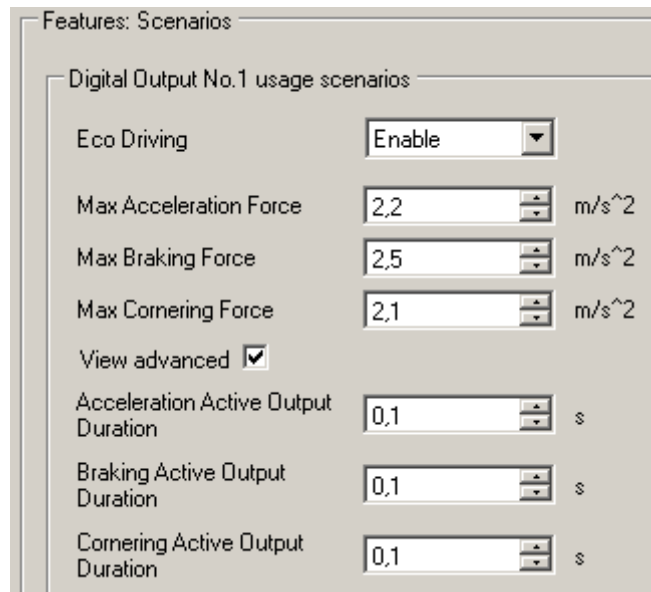

Figure 61 ECO driving configuration parameters

Table 27 ECO Driving parameters description

ECO driving configuration parameter name	Description
Eco Driving	Enable/Disable Eco Driving functionality
Max Acceleration Force	Value which can be reached while accelerating without triggering harsh acceleration event.
Max Braking Force	Value which can be reached while braking without triggering harsh braking event.
Max Cornering Force	Value which can be reached while cornering without triggering harsh cornering event.
Acceleration Detection Sensitivity*	Lower the value to increase sensitivity. Increasing sensitivity means that more acceleration can/will be detected on the same period of time. Response time decreases.
Braking Detection Sensitivity	Lower the value to increase sensitivity. Increasing sensitivity means that more braking can/will be detected on the same period of time. Response time decreases.
Cornering Detection Sensitivity	Lower the value to increase sensitivity. Increasing sensitivity means that more cornering can/will be detected on the same period of time. Response time decreases.
Acceleration Active Output Duration	Set active output duration after harsh acceleration event detected
Braking Active Output Duration	Set active output duration after harsh braking event detected
Cornering Active Output Duration	Set active output duration after harsh cornering event detected

***Example:** Set Acceleration Detection Sensitivity to "0.5". In this case driver can accelerate not

longer than 0.5 second so Eco Driving functionality can detect acceleration. If acceleration lasts 1.2 seconds two harsh acceleration events will be detected and generated.

Data output

Eco Driving functionality generates events on three cases. If vehicles:

- Acceleration exceeds defined parameter value
- Deceleration (braking) exceeds defined value
- Cornering force exceeds defined value

Program continuously monitors and process data from accelerometer than decides whether harsh event is detected or not. If any of three cases are satisfied event is generated. Record is saved and sent to server (FM5500 must be configured properly). Event value is multiplied by 10 before sending/saving record to get more precision when displaying **data***.

Digital output No.1 is activated for a period of time to warn driver. Output on-time should/can be configured separately for each case.

***Example.** If acceleration harsh event of 3.55 m/s² detected. Record with value 3.55*10 = 35.5 ≈ 36 will be saved and sent to server.

12.2 Overspeeding Scenario

Overspeeding. Helps to prevent from exceeding fixed speed and inspects driver if needed. DOUT1 is controlled by scenario for user needs, to manage buzzer, LED etc.

Mounting Requirements and Working Conditions

1. Only one scenario on corresponding Digital Output can be enabled at once.
2. Scenarios on Digital Output No.1 and Digital Output No.2 can be used simultaneously.
3. Device module mounting position doesn't have any influence for correct scenario operation.

Configuration

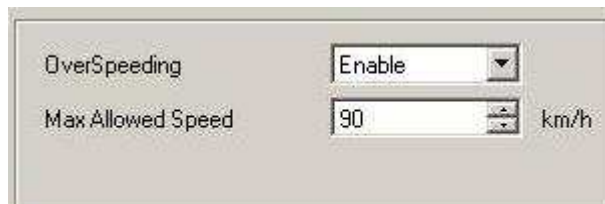

OverSpeeding	Enable	km/h
Max Allowed Speed	90	km/h

Figure 62 Overspeeding configuration parameters

Overspeeding. Enable/Disable Overspeeding.

Max Allowed Speed. Set speed limit to reach without triggering Overspeeding event.

12.3 Immobilizer Scenario

Immobilizer. Vehicle can be used only if iButton is connected. In this scenario iButton list is not used; connect any iButton to pass Immobilizer security. DOUT2 is controlled by scenario for user needs.

Configuration

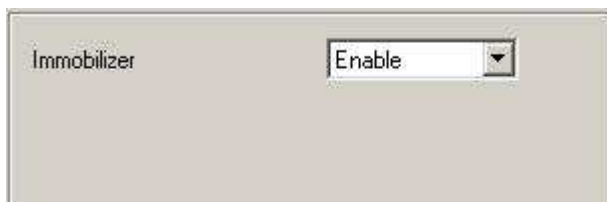

Figure 63 Immobilizer configuration parameters

Immobilizer. Enable/Disable Immobilizer Scenario.

12.4 Authorized Driving Scenario

Authorized Driving. Gives ability to use vehicle only for 50 specific iButton owners (specified in iButton list). DOUT2 is controlled by scenario for user needs, to manage buzzer, LED etc.

Configuration



Figure 64 Authorized driving configuration parameters

Authorized Driving. Enable/Disable Authrized Driving.

Edit iButtons List. Enter authorized iButtons

12.5 COM1 and COM2 Working Modes

Silent Mode

FM5500 doesn't do any activity in silent mode. Logs aren't saved and any data isn't sent.

FM Log Mode

This is default mode of the FM5500. It is suitable for debugging.

LLS Mode

12.5.1.1 LLS Mode Configuration

1. Globals->COM1 Settings->Baudrate = 19200
2. Globals->COM1 Settings->Mode = LLS
3. Globals->COM2 Settings->Baudrate = 19200
4. Globals->COM2 Settings->Mode = LLS

Note

On COM1: Level will be with ID:201 Temperature will be with ID:202 On COM2:
Level will be with ID:203 Temperature will be with ID:204.
On Valid data Receive Status LED will blink.

12.5.1.2 LLS Polynoms Configuration

If additional accuracy is required, LLS fuel sensors can be configured. For polynoms configuration to work both LLS on COM1 and COM2 must be selected. As that is done "Advanced LLS setup" can be clicked. (Figure 65)

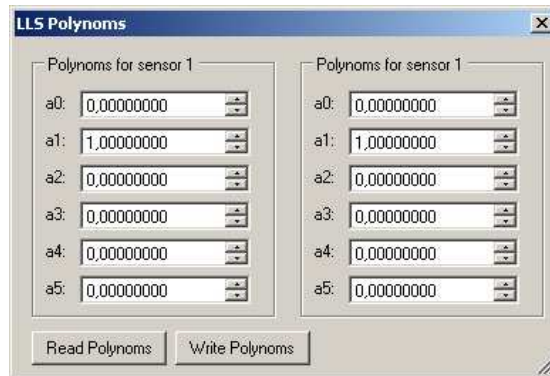

Figure 65 LLS Polynoms Configuration

Multipacket support

With multipacket support FM5500 can put two or more smaller input strings in one bigger special packet⁶. packet. This reduces possibility to miss packets from uart.

Example:

Input String: Hello\$0aHello\$0aHello\$0a

Without Multipacket server will see: Hello\$0a

With Multipacket server will see: Hello\$0aHello\$0aHello\$0a

LCD Mode Configuration

1. Globals->COM1 Settings->Baudrate = 57600
2. Globals->COM1 Settings->Mode = LCD

or

1. Globals->COM2 Settings->Baudrate = 57600
2. Globals->COM2 Settings->Mode = LCD

How to use:

- * From Terminal need send command "WT^W your text here"
- * From Hercules (server) Send "#DO DAT=you text here" (in special packet)

Notes:

#DO DAT= command prints only to COM2

in addition these commands were added:

#DO DAT_1= to print to COM1 #DO DAT_2= to print to COM2

Link between FM and server has to be established for this functionality to work

On Valid data Receive Status LED will blink.

RFID HID Mode Configuration

1. Globals->COM1 Settings->Baudrate = 57600
2. Globals->COM1 Settings->Mode = RFID

or

1. Globals->COM2 Settings->Baudrate = 57600
2. Globals->COM2 Settings->Mode = RFID
3. Globals->COM2 Settings->Parity = Even

⁶ For additional information of special packet, please contact to your local sales representative

RFID MF7 Mode Configuration

1. Globals->COM1 Settings->Baudrate = 9600
2. Globals->COM1 Settings->Mode = RFID MF7

or

1. Globals->COM2 Settings->Baudrate = 9600
2. Globals->COM2 Settings->Mode = RFID MF7
3. Globals->COM2 Settings->Parity = None

Garmin Mode Configuration

12.5.1.3 Settings

1. Globals->COM1 Settings->Baudrate = 9600
2. Globals->COM1 Settings->Mode = Garmin

or

1. Globals->COM2 Settings->Baudrate = 9600
2. Globals->COM2 Settings->Mode = Garmin
3. Globals->COM2 Settings->Parity = None

Ping Filter Enable Parameter:

- 0 - [DISABLED] = Ping packet will not be blocked.
- 1 - [ENABLED] = Ping packet will be blocked.

Unicode Support Packet Enable Parameter:

- 0 - [DISABLED] = Unicode Packet will be sent to server.
- 1 - [ENABLED] = Unicode Support Packet will not be sent to server.

Note:

If the Garmin is selected on com1 and com2 the com1 will be preferred.

These parameters are automatically configured when Garmin mode is selected:

- * if DeepSleep enabled change to Sleep
- * Send Period = 1
- * Record refresh timeout 90900900 sec.
- * ignores weektime, timesync, and records

12.5.1.4 Firmware Configuration

Supported Garmin protocols: A606, A607.

Blocked Garmin ID's:

- Command 0A
- Date/Time Data 0E
- Unit ID/ESN 26
- Pvt Data 33
- Legacy Stop Message 87
- Legacy Text Message 88
- Ping 0260
- Ping response 0261
- Product ID Request 0001
- Product ID Data 0002

FM send ACK the these packets, ant these packets are not sent to server to reduce traffic.

Allowed Garmin ID's:

- ACK 06
- NAK 15
- Fleet Management Packet A1

Note:

If packet are not listed here packet ID will be ignored.

COM TCP Link Mode

In this mode link with external device using text messages can be established.

Any string of data coming to COM will be routed to server. (if link is currently active) First message will be packet to special packet⁷.

If you want to send message to COM, you need to pack in special packet.

1. Globals->COM2 Settings->Baudrate = any of available baudrates
2. Globals->COM2 Settings->Mode = TCP Link Mode
3. Globals->COM2 Settings->Parity = any setting

These parameters are automaticaly configured when TCP Link mode is selected:

- * Record refresh timeout 259200 sec.
- * ignores weektime, timesync, and records

⁷ For additional information of special packet, please contact to your local sales representative

TCP Link Mode (Binary)

This mode is the same as above but binary message will be accepted to/from COM port. This mode also have some advanced filtering capabilities.

1. Globals->COM2 Settings->Baudrate = any of available baudrates
2. Globals->COM2 Settings->Mode = TCP Link Mode
3. Globals->COM2 Settings->Parity = any setting
4. Globals->COM2 Settings->Timeout = any setting (x10 msec.)
(How much time to wait before detecting end of packet)
5. Globals->COM2 Settings->Parity = any setting
6. Globals->COM2 Settings->Prifix1 = any setting
(incoming 1 byte must match to Prefix1 to be accepted)
7. Globals->COM2 Settings->Prifix2 = any setting
(incoming 2 byte must match to Prefix2 to be accepted)
8. Globals->COM2 Settings->Prifix3 = any setting
(incoming 3 byte must match to Prefix3 to be accepted)
(0 and 255 don't care)

NMEA Log Mode

In this mode NMEA logs are sent via COM1 and COM2 ports.

13 SMS COMMAND LIST

SMS commands are used to identify FM5500 current state, possible configuration errors, perform reset, set parameters, switch on/off outputs, etc.

SMS commands should be sent along with module login and password and sender number must be entered in the authorized number list (if at least one other number is entered). Please see SMS settings in chapter 6.3.2.2.2 for more details.

SMS structure is as follows:

<login> <password> <command>

Example:

opa opa getgps

Table 28 SMS command list and description

Command	Description	Response
getstatus	Modem Status information	Yes
getweektime	Current device time, Day of Week and amount of minutes passed since start of week	Yes
getops	List of currently used and available GSM operators	Yes
readops#	Emergency gsm operator readout from active profile # - 1,2,3 1 – operators [1-20] 2 – operators [21-40] 3 – operators [41-50]	Yes
getnmeainfo	Nmea error debug sms	Yes
getcfgtime	Date and Time of last successful configuration	Yes
getgps	Current GPS data and time	Yes
loadprofile#	Load specified profile into RAM Engine Profile. # - number of profile to load	Yes
cpureset	Reset CPU	No
resetallprof	Reset all FLASH profiles to default profile	Yes
getver	Device / Modem / Code version information	Yes
getinfo	Device runtime system information	Yes
deleterecords	Delete all records saved on FLASH	No
getio	Readout digital inputs and outputs, analog inputs	Yes
radio #	Readout input value according entered ID, # - ID value	Yes
setdigout XXXX Y1 Y2 Y3 Y4	Set digital outputs 0 – OFF, 1 – ON Y1 – timeout for DO1 Y2 – timeout for DO2 Y3 – timeout for DO3 Y4 – timeout for DO4	Yes
getparam #	Readout parameter value according entered ID. # - ID value.	Yes
setparam # #	Set parameter value according entered ID and Value.	Yes

	1.# - ID value. 2.# - New Parameter Value	
flush #,#,#,#,#,#,#	Initiates all data sending to specified target server 1.# - IMEI 2.# - APN 3.# - LOGIN 4.# - PASS 5.# - IP 6.# - PORT 7.# - MODE (0-TCP/1-UDP)	Yes
sn x [x=0;1]	Enable/disable static navigation	Yes
banlist	Banlist information	Yes
crashlog	Crash log information	Yes
delete_all_sms	Delete all read SMS	No
braminfo	BatRam info	Yes
getgnss	Current GNSS information	Yes

13.1 getstatus

Table 29 getstatus

Response details	Description
Data Link	Indicate module connection to server at the moment: 0 – Not connected, 1 – connected
GPRS	Indicate if GPRS is available at the moment
Phone	Voice Call status: 0 – ready, 1 – unavailable, 2 – unknown, 3 – ringing, 4 – call in progress, 5 – asleep
SIM	SIM Status: 0-ready, 1-pin, 2-puk, 3-pin2, 4-puk2
OP	Connected to GSM Operator: Numerical id of operator
Signal	GSM Signal Quality [0-5]
NewSMS	Indicate if new message received
Roaming	0 – Home Network, 1 – roaming
SMSFull	SMS storage is full? 0 – ok, 1 – SMS storage full
LAC	Location Area Code
Cell ID	Cell ID

Answer Example: Data Link: 0 GPRS: 1 Phone: 0 SIM: 0 OP: 24602 Signal: 5 NewSMS: 0 Roaming: 0 SMSFull: 0 LAC: 0 Cell ID: 0

13.2 getweektime

Table 30 getweektime

Response details	Description
Clock Sync	Indicates system clock synchronization status. 0 – System is not synchronized, 1 – System synchronized
DOW	Day Of Week – indicates current day of week starting from 0 – Monday, 1 – Tuesday, etc.

Time	Indicates current GMT time
WeekTime	Indicates time in minutes starting from Monday 00:00 GMT

Answer Example: Clock Sync: 1 DOW: 4 Time 12:58 Weektime: 6538

13.3 getops

Table 31 getops

Response details	Description
LIST	Returns list of current available allowed operators.

Answer Example: GSM OP LIST: 0. 24602

13.4 readops#

Table 32 readops#

Response details	Description
LIST	Returns acknowledgment of operators in active profile configuration.

13.5 getnmeainfo

Table 33 getnmeainfo

Response details	Description
BChSum	Nmea packets with bad checksum counter.
HAct	Actual HDOP
BT	Nmea packets with bad timestamp counter
BLat	Nmea packets with bad latitude counter
BLon	Nmea packets with bad longitude counter
BSpd	Nmea packets with bad speed counter
BAng	Nmea packets with bad angle counter
GJC	Nmea packets with GPS jumps counter
Rjc	Rejected Nmea packets counter

13.6 getcfgtime

Table 34 getcfgtime

Response details	Description
Date/Time	Returns last performed configuration date and time.

Answer Example: Last Configuration was performed on: 2010.4.15 5:45:19

13.7 getgps

Table 35 getgps

Response details	Description
GPS	Indicates valid (1) or invalid (0) GPS data

Sat	Count of currently available satellites
Lat	Latitude (Last good Latitude)
Long	Longitude (Last good Longitude)
Alt	Altitude, m
Speed	Ground speed, km/h
Dir	Ground direction, degrees
Date	Current date
Time	Current GMT time

Answer Example: GPS:1 Sat:7 Lat:54.71473 Long:25.30304 Alt:147 Speed:0 Dir:77 Date:2007/8/24 Time: 13:4:36

13.8 loadprofile#

Returns acknowledgment of successful profile changing from currently used to preferred.

Example: Profile Nr.1 successfully changed to Profile Nr.3

13.9 cpureset

Resets cpu – does not send a response back to the sender.

13.10 resetallprof

Resets all FLASH profiles to default profile.

Answer Example: All Profiles Reseted.

13.11 getver

Table 36 getver

Response details	Description
Code Ver	Firmware version
Device IMEI	IMEI
Device ID	Device ID is used to detect which type of configuration to load
Modem App Ver	Version of modem application

Answer Example: Code Ver:0.48.17 Device IMEI:353976010139156 Device ID:000001 Modem APP Ver:2007.11.07

13.12 getio

Table 37 getio

Response details	Description
DI#	Digital Input state
DO#	Digital Output state
AI#	Analog Input state

Answer Example: DI1:0 DI2:0 DI3:0 DI4:0 AI1:0 AI2:0 AI3:0 AI4:0 DO1:0 DO2:0 DO3:0 DO4:0

13.13 getinfo

Table 38 getinfo

Response details	Description
INI	Device Initialization Time
RTC	RTC Time
RST	Restart Counter
ERR	Error Counter
SR	Number of Sent Records
BR	Number of broken records
CF	Profile CRC Fail counter
FG	Failed GPRS counter
FL	Failed link counter
UT	UPD Timeout counter
P#	Current profile
P0:# P1:# P2# P3# P4#	# - how many times appropriate profile was loaded
SMS	Sent SMS Counter
NOGPS	No GPS Timer
GPS	GPS receiver state. 0 – OFF, 1 – restarting, 2 – ON but no fix, 3 – ON and operational, 4 – sleep mode
SAT	Average satellites
RS	Reset Source Identification

Answer Example: INI:2007/8/24 10:15 RTC:2007/8/24 12:43 RST:2 ERR:11 SR:182 BR:0 CF:0 FG:0 FL:0 UT:0 P:1 P0:0 P1:1 P2:0 P3:0 P4:0 SMS:2 NOGPS:0:0 GPS:3 SAT:7 RS:7

13.14 deleterecords

Deletes all saved records from device memory. Device does not send a response back to the sender.

13.15 readio

Table 39 readio #

Response details	Description
ID	IO element ID
Value	IO Element value

Answer Example: IO ID:3 Value:0

13.16 setdigout ##### X Y Z W

Sets digital outputs to ON or OFF state (for some time if needed). Value is written as a row for OUT1, OUT2, OUT3, OUT4 values.

Example: 'setdigout 0010 0 0 5 0' will set OUT3 to high level for 5 seconds, while OUT1, OUT3 and OUT4 to low level.

Ans. example: "DOUTS are set to:0010 TMOs are: 0 0 5 0. Out1 Scenario: Enabled Out2 Scenario: Disabled"

13.17 getparam

Read parameter value. ID consists of 4 digits – first digit identifies profile, second, third and fourth identifies parameter ID as described in Parameters Configuration chapter.

Table 40 getparam #####

Response details	Description
ID	Profile number and parameter ID
Value	Parameter value

Example: 'getparam 1245' command will request server IP address in profile1.

13.18 setparam #####

Sets new value for parameter. ID consists of 4 digits – first digit identifies profile, second, third and fourth identifies parameter ID as described in Parameters Configuration chapter. In value field a new parameter value is entered.

Example: 'setparam 1245 127.0.0.1' will change configured IP address in profile1 with new value

13.19 flush #,#,#,#,#,#

Initiates all data sending by GPRS to specified target server. Comma separated parameters go as numbered:

- 1.# - IMEI
- 2.# - APN
- 3.# - GPRS LOGIN
- 4.# - GPRS PASSWORD
- 5.# - IP
- 6.# - PORT
- 7.# - MODE (0-TCP/1-UDP)

Parameters are separated by comma (no spaces needed). In case you do not need to enter parameter (Login/Pass) – do not put space, simply put comma and write next parameter.

Example: opa opa flush 353976012555151,banga,,,212.47.99.62,12050,0

Table 41 flush

Response details	Description
FLUSH SMS Accepted	FLUSH SMS Accepted
# records found on FLASH	Number of records found on FLASH
Minimum Records to Send: #	Number of minimum saved records to send
GPRS Enabled: #	State of the GPRS connection, 0 – disabled; 1 – enabled
Time Sync: #	Indicates time synchronization on the device, 0 – not synchronized; 1 – synchronized

Answer Example: FLUSH SMS Accepted. 11 records found on FLASH. Minimum Records to Send: 1. GPRS Enabled: 1. Time Sync: 1.

13.20 getgnss

Table 42 getgnss

Response details	Description
FIX	GPS fix
SAT GL	Total glonass sattelites
GP	Total gps sattelites

Answer Example: FIX:1 SAT GL:5 GP:10

13.21 sn x

Returns state of static navigation and previous state: Static Nav is Disabled. Was:X or Static Nav is Enabled. Was:X (1 – enabled, 0 – disabled). If sent X is not 0 or 1, then response is: WARNING: Undefined SN parameter: X.

13.22 banlist

Returns a list of possible banned operators. If device returns zeroes, there are no banned operators saved. Format: A.Bs.C.D

Table 43 banlist

Response details	Description
A	Banned operator code
Bs	Time left
C	Reason (GSM or GPRS
D	Counter (how many times this operator code was already banned)

13.23 crashlog

Returns list of possible device crashes.

13.24 braminfo

Table 44 braminfo

Response details	Description
Boot	Bootloader parameter
Uptime	Device uptime
RST	Device reset counter
IWDF_RST	Independent watchdog reset counter
BadRec	Bad record counter
AD	Authorized driving state
GD	Green driving state
IM	Immobilizer state

13.25 setsimslot

This SMS command is used to switch the SIM slot forcibly. After this command is sent to FM5500 the SIM disconnects from operator and switches to another SIM card, then it connects to another SIM card's operators by priority. If after switching FM5500 connects to an unavailable operator after 10 minutes it will connect to an optimal operator. If optimal operator for SIM 2 is unavailable, FM5500 switches the SIM slot and tries to connect to optimal SIM 1 operator.

```
setsimslot <val> ,
<val> 0 – SIM1, 1 – SIM2
```

13.26 getsiminfo

Returns the active SIM info, FM5500 is using at the moment.

Answer Example:

```
SL:0,S1F:0,S1S:0,S1I:246021005041494,S1H:24602,S1R:0,S2F:0,S2S:0,S2I:,S2H:0,S2R:0
```

Table 44 getsiminfo

Response details	Description
SL	SIM Slot [0,1]
S1F	SIM1 Forced Switch
S1S	SIM1 Status
S1I	SIM1 IMSI
S1H	SIM1 HOME Operator
S1R	SIM1 Roaming Operator
S2F	SIM2 Forced Switch
S2S	SIM2 Status
S2I	SIM2 IMSI
S2H	SIM2 HOME Operator
S2R	SIM2 Roaming Operator

14 CAN

Controller Area Network (CAN or CAN-bus) is a computer network protocol and bus standard designed to allow microcontrollers and devices to communicate with each other and without a host computer. It was designed specifically for automotive applications but is now also used in other areas.

SAE J1939 is the vehicle bus standard used for communication and diagnostics among vehicle components. Based on the same architecture FMS protocol dedicated to telematics systems is available. It has certain standardized parameters available, such as fuel consumption, engine work-hours, etc. Please visit <http://www.fms-standard.com/> for more information and message structure.

The FMS-interface is an optional interface of different truck manufacturers. Supported information is dependent upon vehicle equipment. For the full information set, additional Electronic Control Units (ECU) may be required. Please contact the manufacturer or your dealer for more details.

Vehicle brands supported:

- Mercedes Benz
- Volvo
- MAN
- DAF
- Iveco
- Scania
- Renault

Available parameters:

- Total Fuel
- Total Distance
- Status of brake pedal *
- Engine Torque *
- Actual fuel
- Accelerator pedal position *
- Status engine brake
- Speed *
- RPM
- Engine hours
- Vehicle Weight *
- Fuel level
- Tachograph data *

14.1 General description

- CAN works if no USB cable is inserted and isn't in deep sleep mode;
- Uses six different speeds: 50 kbps, 100 kbps, 125 kbps, 250 kbps, 500 kbps;
- Auto Baud rate detection;
- Filtering messages (StdId, ExtId) according to configuration;
- Using mask, filters required bytes;

- Different CAN configurations.

14.2 Configuration

Manual CAN data can be configured using “Manual CAN” in CAN tab, figure below (Figure 386 CAN configuration window).

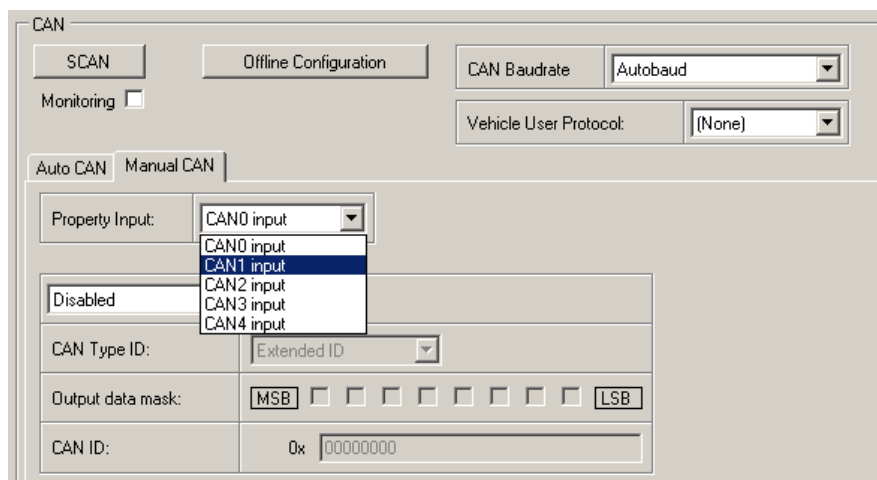

Figure 386 CAN configuration window

CAN baud rate configuration: speed depends on operating CAN network speed, if that speed is unknown “Autobaud” mode is recommended (Figure 397 CAN baud rate configuration window);

* Availability of parameter depends on vehicle’s model and configuration of FMS interface of the truck.

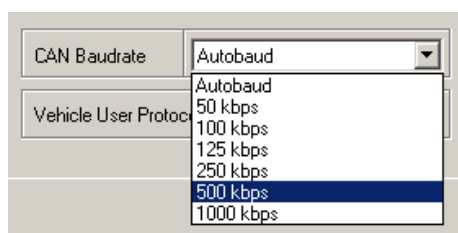

Figure 397 CAN baud rate configuration window

Note that If FM5500 is set to “Autobaud” mode it will always check for CAN network even if device isn’t connected to any of it.

CAN message ID type: Message ID type (Figure 408 CAN message ID types6) two types according to SAEJ1939 standard: Standard ID (value: 0 to 0x7FFh) and Extended ID (value: 0 to 0x1FFFFFFh).

CAN Type ID:	Standard ID
Output data mask:	Standard ID Extended ID

Figure 408 CAN message ID types

Message ID value is entered in hex format. This parameter is used to configure hardware message filter (Figure 4169). All messages contain 8 bytes of data, to select particular data/bytes “Output Data Mask” is used, it’s done by ticking required bytes, only selected bytes are sent to server.

CAN Type ID:	Extended ID
Output data mask:	MSB <input type="checkbox"/> <input type="checkbox"/> <input type="checkbox"/> <input type="checkbox"/> <input checked="" type="checkbox"/> <input checked="" type="checkbox"/> <input checked="" type="checkbox"/> <input checked="" type="checkbox"/> LSB
CAN ID:	0x FFFEE9FF

Figure 419 CAN message filter configuration

14.3 Example

A sample CAN message has the following structure: X18FEE9018FFFFFFFF23840300, where essential parts are ‘FEE9’ – identifier and ‘FFFFFFFF23840300’ – data bytes.

CAN messages are configured like any other I/O parameters. They consist of 4 identifier bytes and 8 data bytes. Below you will find a sample configuration for fuel consumption parameter:

ID type – is always 29 bits.

Output data mask – defines which data bytes are sent to the server (sometimes not all data bytes are necessary).

CAN ID – this is 4 byte identifier. Messages use 4 bytes, but the first and last bytes may differ in different vehicle models while the middle four bytes are the same for all vehicles. The first and last bytes may have any value. Because of this reason it is recommended to write FF in the first byte and the same in the last byte.



This information is provided only as an example and Teltonika takes no responsibility for information accuracy or damage that may be done to the vehicle or FM5500 module while integrating it.

Example:

All Mercedes Benz Actros 2 models with Vehicle Identification Number (VIN) starting with WDB93 have a possibility to connect FM5500 module to CAN bus. This can be done by connecting to special PSM module (which may or may not be included in the truck) or ground module of the vehicle. For CAN signal to be available, parameter 520 must be enabled in “kommunikationsschnittstelle” in the vehicle with Mercedes Stardiagnose.

CAN wires can be found on X5 connector located in the fuse box (Figure 70):

Pin 5: CAN Low signal (yellow wire)

Pin 2: CAN High signal (blue wire)

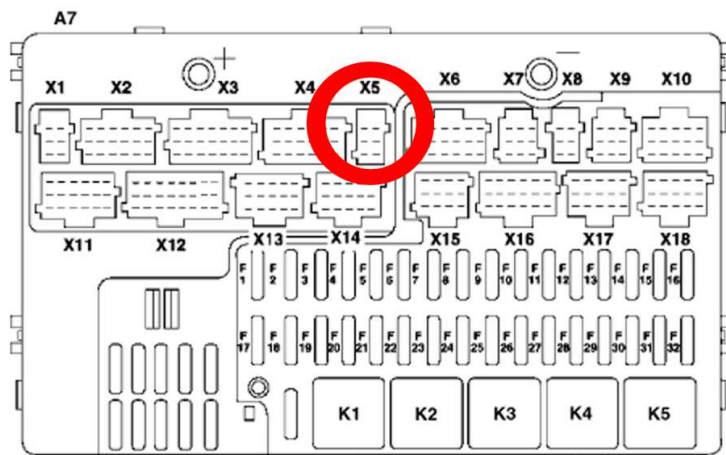

Figure 70 X5 plug on Mercedes Benz

In the example FM5500 will filter all CAN messages with identifier FFFEE9FF (fuel consumption) (Figure 4271).

Figure 421 CAN parameter configuration example



Note: Averaging constant cannot be used with CAN data, because this information comes in digital format. So in order to prevent data loss, set Averaging constant parameter to 1.

Most parameters have certain resolution. FEE9 parameter has 0.5L/bit gain, so value that is sent to server has to be multiplied by 0.5.

Data parsing is preceded by selecting correct message from all available on CAN bus. FMS standard interface description indicates that fuel consumption is parameter with ID FEE9:

Table 45 FMS standard – fuel consumption

00FEE9								PGN Hex
65,257								PGN
1000 ms								Rep. Rate
Data Byte 1	Data Byte 2	Data Byte 3	Data Byte 4	Data Byte 5	Data Byte 6	Data Byte 7	Data Byte 8	Byte No.

Not used for FMS-Standard	Not used for FMS-Standard	Not used for FMS-Standard	Not used for FMS-Standard	Total fuel used 0,5 L/Bit gain 0 L offset 5.2.5.66 SPN 250	Total fuel used 0,5 L/Bit gain 0 L offset 5.2.5.66 SPN 250	Total fuel used 0,5 L/Bit gain 0 L offset 5.2.5.66 SPN 250	Total fuel used 0,5 L/Bit gain 0 L offset 5.2.5.66 SPN 250	Name Values Values Values SAE ref SPN
---------------------------	---------------------------	---------------------------	---------------------------	--	--	--	--	--

The example indicates how fuel consumption message is selected and how configuration impacts this selection (Figure 43).

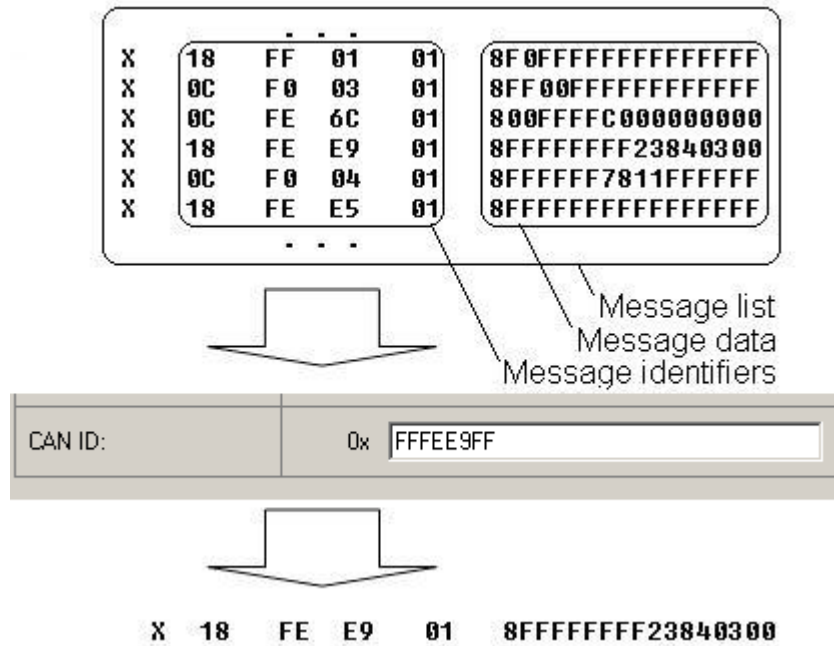

Figure 432 Fuel consumption message indication

When certain message is filtered, FM5500 checks which data bytes should be sent to server. Document indicates that 5-8 bytes are used in FMS standard.

Table 46 FMS standard – fuel consumption (5-8 bytes)

Data Byte 5								Data Byte 6								Data Byte 7								Data Byte 8								Byte No.
8	7	6	5	4	3	2	1	8	7	6	5	4	3	2	1	8	7	6	5	4	3	2	1	8	7	6	5	4	3	2	1	Bit no
Total fuel used								Total fuel used								Total fuel used								Total fuel used								Name
0,5 L/Bit gain								0,5 L/Bit gain								0,5 L/Bit gain								0,5 L/Bit gain								Values
0 L offset								0 L offset								0 L offset								0 L offset								Values
5.2.5.66								5.2.5.66								5.2.5.66								5.2.5.66								SAE
SPN 250								SPN 250								SPN 250								SPN 250								ref
																																SPN

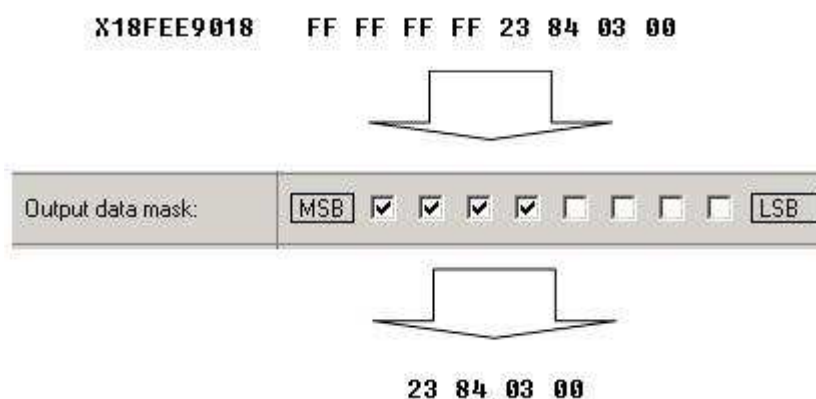

Figure 443 Filtered CAN data

Data bytes are filtered by selecting the checkboxes in Output data mask. Note, that configurator has them listed starting with MSB.

After message is filtered it is attached to the data packet and sent to the server. Values are returned in HEX. 00 03 84 23(HEX) = 230435(DEC). Notice, that data resolution is 0.5L/bit gain – value has to be multiplied by 0.5, therefore vehicle used total of 115217,5 liters of fuel since it

14.4 AutoCAN description

AutoCAN function allows user to automatically scan for available messages on CAN bus and configure CAN data sending to server. In order to configure AutoCAN connect FM5500 to computer with Port ½ cable. Launch FM55xx configurator. Push “Connect“ button, then „CAN“ button (Fig. 74). CAN configuration menu will be opened (Figure 75).

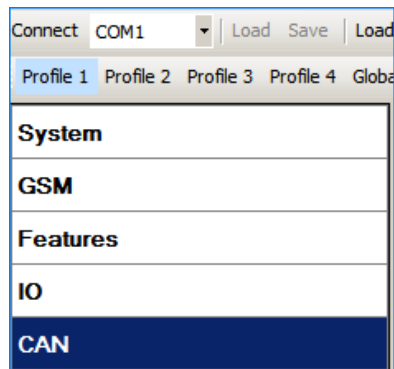

Figure 74 Entering CAN configuration

- SCAN scans once for available messages on CAN bus;
- Monitoring – toggles scanning of messages on CAN bus every 3 seconds;
- Offline Configuration – enables CAN configuration when FM53xx is not connected to CAN bus;
- Auto CAN tab – configure CAN by selecting available messages from CAN bus;
- Manual CAN tab – Configure CAN by manually entering CAN message ID and data mask;

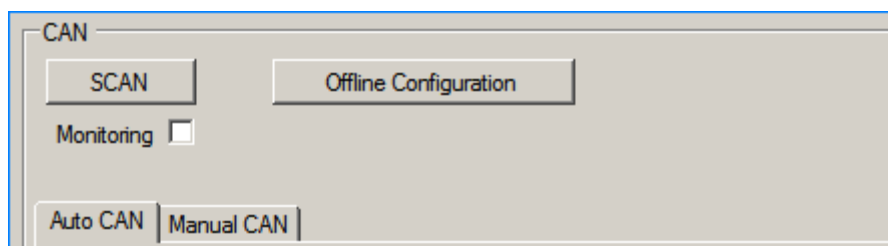

Figure 75 CAN configuration menu

Configuration

To start CAN configuration push “SCAN” button. A table of all available CAN messages will appear (Fig. 75). Description of columns:

- Category – shows CAN message;
- Parameter – shows configurable parameter name;
- Value – shows scanned value of parameter;
- Send data to server – allows to choose the type of data when it’s generated:
 - Disabled – Data will not be collected
 - On low priority – records will be generated as low priority events;
 - On high priority – records will be generated as high priority events and immediately sent to server via GPRS (if GPRS is available);
 - On panic - records will be generated as panic priority events and immediately sent to server via GPRS, if GPRS is not available records will be sent via SMS messages;
- Data acquisition type – allows to choose when records are generated:
 - Monitoring – monitors data;
 - On change – record is generated when parameter value is changed;
 - Hysteresis – record is generated when increasing parameter value becomes higher than High value, and decreasing becomes less than Low value

- Event on exit – record is generated when parameter value becomes higher than High value or lower than Low value;
- Event on entrance – record is generated when parameter value becomes between High and Low values;
- Event on both – record is generated when parameter value crosses High or Low values;
- Low – allows to choose low value for Data acquisition;
- High – allows to choose High level for Data acquisition;

Monitoring filters						
Category	Parameter	Value	Send Data To Server	Data Acquisition Type	Low	High
Cruise Control/Vehicle Speed	Brake switch	Pedal released	Disable	Monitoring		
	Wheel based speed	0 km/h	Disable	Monitoring	0	0
	Cruise control active	Off/disabled	Disable	Monitoring		
	Clutch switch	Pedal released	Disable	Monitoring		
	PTO state	Off/disabled	Disable	Monitoring		
Electronic Engine Controller #2	Accelerator pedal position 1	0 %	Disable	Monitoring	0	0
	Engine Percent Load At Current Speed	0 %	Disable	Monitoring	0	0
Fuel Consumption	Engine total fuel used	0 liters	Disable	Monitoring	0,0	0,0
Dash Display	Fuel level 1	0 %	Disable	Monitoring	1	1
Electronic Engine Controller #1	Engine speed	0 rpm	Disable	Monitoring	0,000	0,000

Figure 76 CAN data table

CAN monitoring

To start CAN bus monitoring mark Monitoring check box. Table of available CAN messages will appear (Fig. 60). Data from CAN bus will be updated every 3 seconds. In order to see only desired data open “Monitoring filters” menu (Figure 77).

Monitoring filters			
<input type="button" value="Select All"/>		<input type="button" value="Select None"/>	
<input checked="" type="checkbox"/> Brake switch	<input checked="" type="checkbox"/> Wheel based speed	<input checked="" type="checkbox"/> Cruise control active	<input checked="" type="checkbox"/> Clutch switch
<input checked="" type="checkbox"/> PTO state	<input checked="" type="checkbox"/> Accelerator pedal position 1	<input checked="" type="checkbox"/> Engine Percent Load At Current Speed	<input checked="" type="checkbox"/> Engine total fuel used
<input checked="" type="checkbox"/> Fuel level 1	<input checked="" type="checkbox"/> Engine speed	<input checked="" type="checkbox"/> Axle location1	<input checked="" type="checkbox"/> Tire location1

Figure 77 Monitoring filters

Monitoring filters menu allows choosing which data will be shown in configuration menu. To enable/disable particular data monitoring use checkbox next to data name. To enable all data monitoring push “Select all” button, to disable all data monitoring push “Select none” button.



Note: CAN monitoring is FM5500 configurator function; it does not enable data sending to server. In order to configure data sending to server refer to Configuration section.

Offline configuration

When FM5500 device is not connected to CAN bus you can configure CAN data sending by pushing “Offline configuration” button. When offline configuration is enabled a configuration table of all FMS standard CAN data is shown.

AutoCAN ID list

Table 47 AutoCAN ID list

Category name	Par Nr in P:FMS:	Par Nr. In P:FMSDAT:	(signal) name	Size (Bytes)	Param IO ID	Value range
65265 – Cruise Control/Vehicle Speed	1	1	Brake switch	1	79	0-1 0 = pedal released 1 = pedal depressed
	2	2	wheel based speed	4	80	0-65536 (km/h)*
	3	3	cruise control active	1	81	0-1 0 = switched off 1 = switched on
	4	4	clutch switch	1	82	0-1 0 = pedal released 1 = pedal depressed
	5	5	PTO state	1	83	0-3 0 = off/disabled 1 = Set 2 = not available
61443 – Electronic Engine Controller #2	6	6	accelerator pedal position 1 X	4	84	0-102 (%)*
	7	7	Engine Percent Load At Current Speed X	1	85	0-125 (%)*
65257 – Fuel Consumption	8	8	Engine total fuel used	4	86	0 – 2105540607,5 (Liters)*
65276 – Dash Display	9	9	fuel level 1 X	4	87	1-102 (%)*
61444 – Electronic Engine Controller #1	10	10	engine speed X	4	88	0 – 8031,875 (rpm)*
65258 – Vehicle Weight **	[11-25] (Tire No 1 - 15)	11	Axle location	1		1-15
			Tire location	1		1-15
			Axle weight	4	[89 – 103]	32766 (kg)*
65253 – Engine Hours, Revolutions: HOURS	26	12	Engine total hours of Operation X	4	104	0 – 214748364 (Hours)*
65260 – Vehicle Identification	27	13	vehicle identification number X	Max 24	[105 - 108]	Max 24 ASCII bytes
64977 – FMS Standard interface	28	14	SW-version supported X	4	109	4 ASCII bytes (Version format – ab.cd)
	29	15	Diagnostics supported X	1	110	0-3 0 = diagnostics is not supported 1 = diagnostics is supported 2 = reserved 3 = don't care
	30	16	Requests supported X	1	111	0-3 0 = request is not supported 1 = request is supported 2 = reserved 3 = don't care

65217 - High Resolution Vehicle Distance	31	17	High resolution total vehicle distance X	4	112	0 - 21055406 km*
65216 - Service Information	32	18	Service distance	4	113	-160 635 – 167040 km*
65132 - Tachograph	33	19	Vehicle motion X	1	114	0 – Motion Not Detected 1 – Motion Detected
	34	20	driver 2 working state X	1	115	0 – Rest 1 – Driver Available 2 – Work 3 – Drive 4 – Error 5 – not available
	35	21	driver 1 working state X	1	116	0 – Rest 1 – Driver Available 2 – Work 3 – Drive 4 – Error 5 – not available
	36	22	Vehicle overspeed	1	117	0 – No Overspeed 1 – Overspeed
	37	23	Driver 1 time rel. states	1	118	0 – Normal 1 – 15min bef. 4,5h 2 – 4,5h reached 3 – 15min bef. 9h 4 – 9h reached 5 – 15min bef. 16h 6 – 16h reached 7 – Error 8 – not available
	38	24	Driver 2 time rel. states	1	119	0 – Normal 1 – 15min bef. 4,5h 2 – 4,5h reached 3 – 15min bef. 9h 4 – 9h reached 5 – 15min bef. 16h 6 – 16h reached 7 – Error 8 – not available
	39	25	Driver 1 card X	1	120	0 – Card Not Present 1 – Card Present
	40	26	Driver 2 card X	1	121	0 – Card Not Present 1 – Card Present
	41	27	Direction indicator	1	122	0 – Forward 1 – Reverse
	42	28	Tachograph performance X	1	123	0 – Normal Performance 1 – Performance Analysis
	43	29	Handling information X	1	124	0 – No Handling Information 1 – Handling Information
	44	30	System event X	1	125	0 – No Tacho Event 1 – Tacho Event
	45	31	Tachograph vehicle speed X	2	126	[0 – 65000] – Tacho Vehicle Speed km/h*
65262 - Engine Temperature 1	46	32	engine coolant temperature X	1	127	[-40 – 210] oC– Engine Coolant Temperature*

65269 - Ambient Conditions	47	33	Ambient Air Temperature X	2	128	[-273 – 1770]oC – Ambient Air Temperature*
65131 - Driver's Identification	48	34	Driver 1 Identification	32	129,130,131	24 ASCII Bytes per Driver ID
65131 - Driver's Identification	49		Driver 2 Identification X	32	132,133,134	24 ASCII Bytes per Driver ID
65266 – Fuel Economy	50	35	Fuel rate X	4	135	[0 – 3212,75] litres/h*
	51	36	Instantaneous Fuel Economy X	4	136	[0 – 125.5 km/litre]*
64932 - PTO Drive Engagement	52	37	At least one PTO engaged	1	137	0 – No PTO Drive is Engaged 1 – At least one PTO drive is engaged 2 – Error 3 – not available
64777 - High Resolution Fuel Consumption (Liquid)	53	38	High resolution engine total fuel used	4	138	[0 - 4211081,215] litres*

15 RS485 INTERFACE

RS485 supports only Half Duplex communication. It means that at the same time you can't send/receive Data.

When activated RS485 driver chip draws constant 30mA current.

When Entering Sleep or Dsleep Chip will be powered off too.

15.1 RS485 modes

In Configurator's windows select External devices window where is RS485 Settings as shown in Figure 4578.

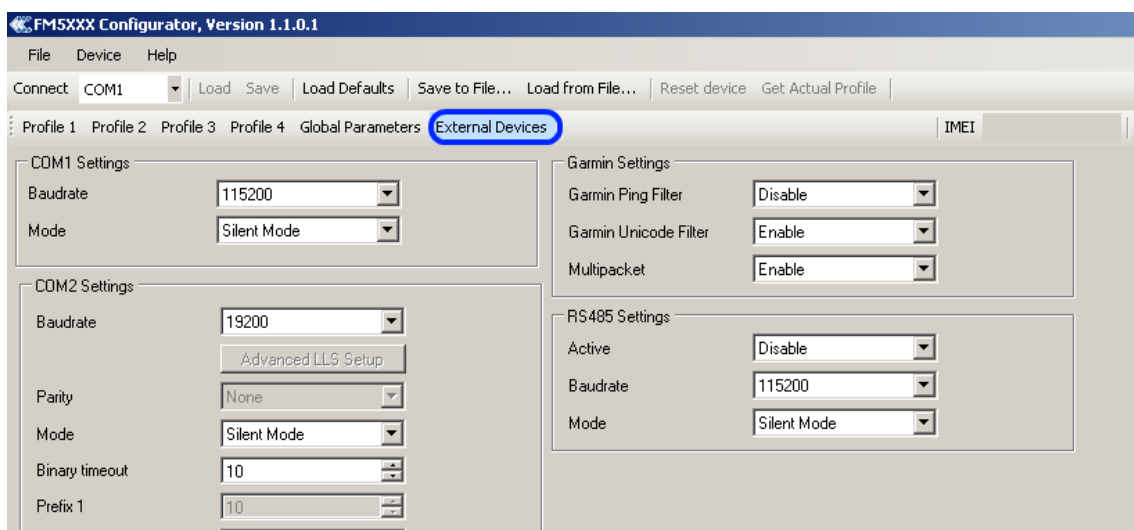

Figure 458 RS485 Settings window

The modes are described below are setting in the configuration window.

RS485 Receive (Silent) Mode

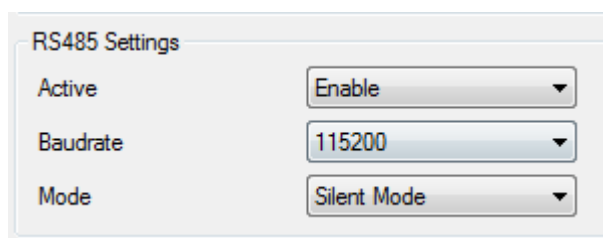

Figure 79 Silent Mode

RS485 Works in receive mode. Support debug and testing commands. When command is received answer is sent after that it back up to Receive mode.

RS485 Receive (TCP Link) Mode

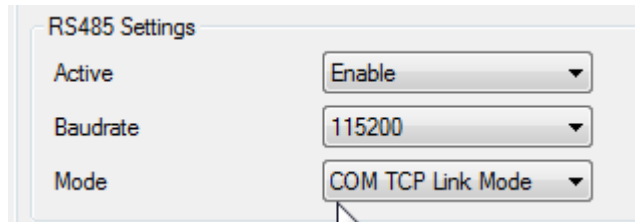

Figure 460 COM TCP Link Mode

RS485 works in receive mode. When data received from server RS485 is switched to transmit mode for 2 seconds.

RS485 Receive (LLS) Mode

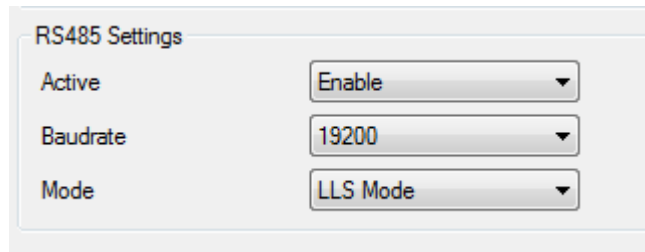

Figure 471 LLS Mode

The mode supports up to two LLS. Baud rate must be 19200. LLS have receiver id. Smaller ID will get ID: 201 and ID: 202. Bigger ID will get ID: 203 and ID: 204

RS485 Transmit (FM Log) Mode

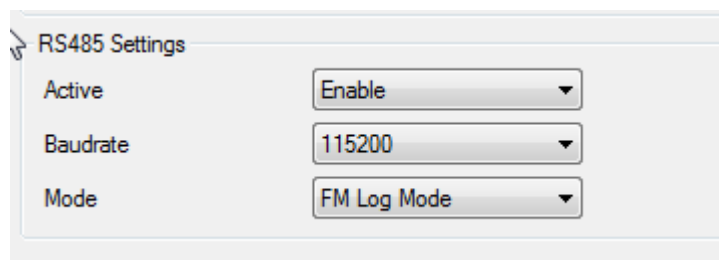
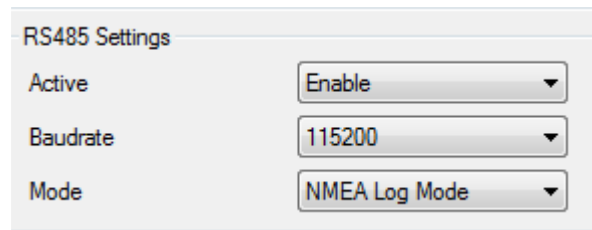

Figure 482 FM Log Mode

RS485 works in transmit mode, it prints FM log. It won't respond to commands

RS485 Transmit (GPS Nmea) Mode



RS485 Settings

Active	Enable
Baudrate	115200
Mode	NMEA Log Mode

Figure 493 NMEA Log Mode

RS485 works in transmit mode, it prints NEMA. It won't respond to commands

RS485 Self-Test Mode

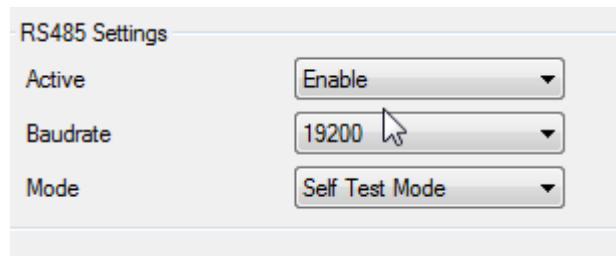

RS485 Settings

Active	Enable
Baudrate	19200
Mode	Self Test Mode

Figure 504 Self Test Mode

Both transmitter and receiver are active. Transmitted info will be echoed back.

15.2 RS485 interface

Port connection diagram are shown on the Figure 515:

FM5300 RJ-45 (Female)	PORT 1	
	Pin Nr.	Description
	1	RS485 B
	2	RS485 A
	3	
	4	GND
	5	RS232 Tx
	6	RS232 Rx
	7	RS232 CTS
	8	RS232 RTS

Figure 515 Port 1 connection diagram

Pins numbers 1 and 2 are intended to RS485 interface connection.

16 RFID

Radio-frequency identification (RFID) is the use of a wireless non-contact system that uses radio-frequency electromagnetic fields to transfer data from a tag attached to an object, for the purposes of automatic identification and tracking. FM5500 can be configured in a way to use with an RFID reader. When an RFID of some sorts (typically a plastic card with a magnetic line) is used with an RFID reader which is connected to FM5500, the device creates a record with the data that the RFID reader has read and can be sent to a server with all other information. RFID ID is activated like an I/O parameter (Figure 5286).

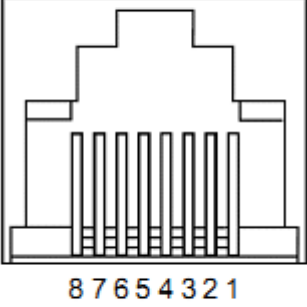
I/O	
Property input:	33 : (Enabled) RFID ID
	Enabled
Priority:	High
High level:	0
Low level:	0
Generate event:	Monitoring
Averaging constant:	10
Bytes Available	199

Figure 526 RFID I/O parameter

To set up FM5500 so it can be connected to an RFID reader, Global parameters have to be set up. Go to Global parameters and set up COM1 or COM2 settings to RFID Mode or RFID MF7 Mode (the used mode depends on the mode that the RFID reader works). See Figure 5387. The Baudrates for each mode are:

RFID Mode – 57600

RFID MF7 Mode – 9600

You cannot set RFID modes for both COM ports – one has to be chosen – either COM1 or COM2.

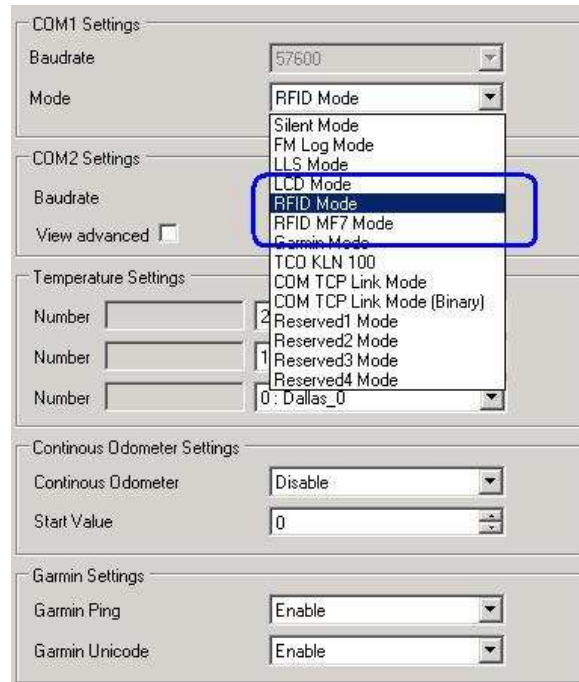

Figure 537 RFID Global parameter settings

The difference between RFID Mode and RFID MF7 Mode is that in RFID Mode FM5500 understands RFID messages that are in hexadecimal format and RFID MF7 Mode understands messages that are in decimal format. For example:

RFID Mode message – “\$aa\$02\$03\$04\$17\$89\$00\$01”

RFID MF7 Mode message – “1213141519”

The chosen mode has to correspond to the RFID reader’s mode. What type of RFID is sent to FM5500 depends on the reader.

For more information about RFID ID’s and devices, please contact to your local sales representative.

17 GARMIN

Garmin provides a Fleet Management Interface Tool Kit which connected to FM5500 enables the driver to have a "screen" in their vehicle for real-time navigation, messaging, and job dispatch capabilities to help them be more efficient.

FM5500 and Garmin operational scheme is shown in Figure 5488 below:



Figure 548 FM53+Garmin operational scheme

17.1 Supported Garmin FMI Protocols

The following is a list of protocols supported and the corresponding feature/benefit. FM5500 can fully support Fleet Management Interface (FMI) versions up to 2.1. Other or higher versions may be supported, but Teltonika is not responsible for the changes made by Garmin, which may affect the work of FM5500 and Garmin products. For more information about Garmin products and FMI versions, please go to <http://www8.garmin.com/solutions/pnd/supportedproducts.jsp>. Notice that some Garmin products use different connection cables than others.

Standard protocols

Text Message Protocol:

- Allows text messages sent to device to be displayed in "inbox" on unit.
- Garmin can provide confirmation that message was read.
- Garmin can also provide a yes/no box below the text of the message to enable a simple quick response.
 - Messages can be up to 199 characters in length.
 - Messages can also be generated from device and sent to dispatch/office.
 - Messages received will be notified to driver through a pop-up alert on Garmin screen.
 - Garmin provides a "virtual keyboard" on device through a touch-screen format for all text communication.

Stop (Destination) Protocol:

- Garmin can display a list of Stops/Jobs reported to the device in a separate icon called "My Stops".
 - Driver has ability to navigate directly to Stop from list.
 - Garmin can provide status on current Stop in progress.
 - Is driver stopped at location?
 - How far has Driver progressed through the list of Stops?
 - Garmin can also provide confirmation that driver has received a particular Stop, read the details, or deleted it from list.

- Can provide confirmation that a Stop has been completed.

Estimated Time of Arrival Protocol:

- Dispatcher/office can request the ETA of the current stop/job in progress.
- Garmin will notify the actual time of arrival as well as distance remaining to stop.

Auto-Arrival at Stop Protocol:

- This feature is used to tell the Garmin PND to automatically detect that it has arrived at a Stop and then to prompt the driver if they would like to mark the Stop as done and begin navigating to next Stop on the list.
- Auto-arrival can be determined by how long the unit is stopped close to the destination (in the event driver has to park and walk) or by how close the unit needs to be to the destination before the Auto-arrival feature is activated.

Data Deletion Protocol:

- Dispatch/office has the ability to wipe clean the data on the Garmin PND.
- Clean up messages in inbox/remove stops.

Enhanced protocols

Canned Responses/Messages:

- Fleet managers can communicate by sending up to 200 "canned" responses from server to be stored directly on Garmin devices.
- Up to 50 of these canned responses can be utilized for any given scenarios.
- Drivers can store up to 120 canned messages, eliminating the need to type while driving.

Status Protocol:

- Up-to-the-minute communications that allow drivers to automatically send status updates.
- Driver's units can store up to sixteen status indicators such as start/stop shift, on/off break, etc.

17.2 Supported features on Tavl client application

Tavl client application lets user to use the following features of GARMIN FMI:

1. Text messaging.
2. Destination message.
3. ETA request.

17.3 Text messaging

Text messaging feature lets user to communicate with driver (user that uses Garmin device) by sending text messages via GPRS.

17.4 Destination message

Destination message is used to inform a driver of a new destination. When Garmin device receives a destination message from server it displays it as "Stop" to the driver and also gives the

driver ability to start navigating to the “Stop” location. New destination in Tavl client is represented as Geozone so new Geozone (as destination) has to be created first.

17.5 ETA request message

ETA (Estimated Time of Arrival) request message is used when user wants to know expected arrival time to currently active destination and distance (in meters) from current object location to currently active destination.

17.6 Connection and pinout

FM5300 RJ-45 (Female)	
Pin Nr.	Description
1	
2	
3	
4	GND (Black wire)
5	Rx (White wire)
6	Tx (Yellow wire)
7	
8	

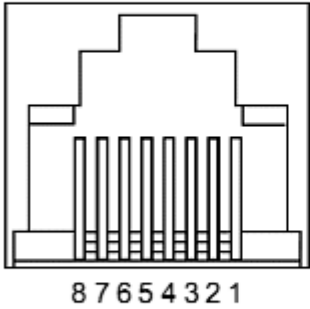

Figure 89 RJ45 Pinouts

In order to connect Garmin PND to FM5500, Garmin mode has to be set in Global parameter settings (figure 89). Simply choose Garmin mode in either COM1 or COM2 settings mode, but you cannot activate Garmin mode in both ports at the same time.

FM5500 is able to filter out some of Garmin FMI packets that are not used in some applications (including Tavl system) and generates additional data transfer at the same time increasing bills of GSM services. In order to enable Garmin FMI Ping Packet Filtering set this feature from Global parameters at the bottom – enable Garmin Ping setting (see Figure 5590).

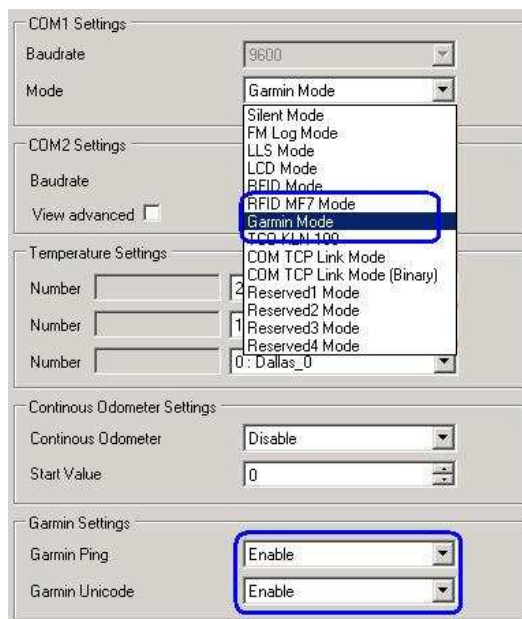

Figure 550 Configuration of Garmin in Global parameter settings



NOTE: Garmin FMI protocols are supported only in TCP data transfer mode.



Garmin Fleet management Interface documentation can be downloaded from Official Garmin web page: http://developer.garmin.com/download/FMI_v2-5.zip.

Software version updates: <http://www8.garmin.com/support/download.jsp>.

For more information about Garmin PND device connectivity to FM5500 and additional information, please contact to your local sales representative.

18 LLS SENSOR

LLS sensor series liquid level sensors are solid-state capacitive devices with no moving parts. The sensors use capacitive technology to produce accurate liquid level measurements of standard factory grade DIESEL OIL and PURE GASOLINE (BENZINE) carbon fuels.

The LLS sensor liquid level sensors are strictly prohibited to use in any liquids which are not the factory grade carbon fuels or contain: BIOFUEL, METHANOL, ETHANOL, UREA and similar aggressive components in pure form or as additives for factory grade carbon fuels for use in INTERNAL COMBUSTION ENGINES. Operating media – Diesel fuel (oil), pure gasoline (benzene).



IMPORTANT!

The power supply is 10-50 VDC stabilized. The wrong polarity (-) or (+) connection of power supply will damage or destroy the device. Prohibited for test or use in water and any other liquids, which are not factory grade carbon fuels. Fit the plastic insulation cap on the end of the central rod after

installation accordingly to installation guide. To be installed, calibrated, tested only by qualified authorized person (installer, technician, mechatronic).

18.1 Specifications

Supply voltage, DC V	10...50*
Current consumption, mA (for 12/24 V)	25/50
Operation temperature, Celsius degrees	-40...+85
Working mode	continuous
Weight, kg	< 2.0
Working pressure	atmospheric

18.2 Hardware

- Operation principle: capacitive.
- Output: RS-232 or RS-485.
- Standard probe lengths: 700, 1000, 1500 mm.
- Optocoupler isolation on both power and signal circuits.

LLS wires colors and description:

LLS wire color	Interface	Wire purpose
Brown	Power supply	«+» Power supply
White	Power supply	Common («Ground»)
Grey	RS-232	Sensor Rx
Pink	RS-232	Sensor TX
Blue	RS-485	Line A
Red	RS-485	Line B

18.3 Connecting LLS to FM5500

In order to use LLS fuel counter the 01.00.01 Firmware version or later is needed which can be obtained from Teltonika or a representative. Firmware is updated by RILS system over GPRS or using cable update method (see chapter 4 for more information).

The LLS fuel sensor can be connected to the FM5500 device via RS232 or RS485 interface. Port 1 has both RS485 and RS232 interface. On Port 1 both RS-485 and RS-232 can be used at the same time. Port 2 can use only RS-232 protocol. The FM5500-LLS fuel sensor connection schemes are shown below.

*Teltonika is not responsible for any changes made by the manufacturer, which is not declared in fuel level sensor documentation.

FM5500-LLS two fuel sensors connection via RS232 scheme RJ-45 male plug to Port 1 and one fuel sensor connection via RS485 to Port 1 (1 pin and 2 pin) is shown on Figure 561.

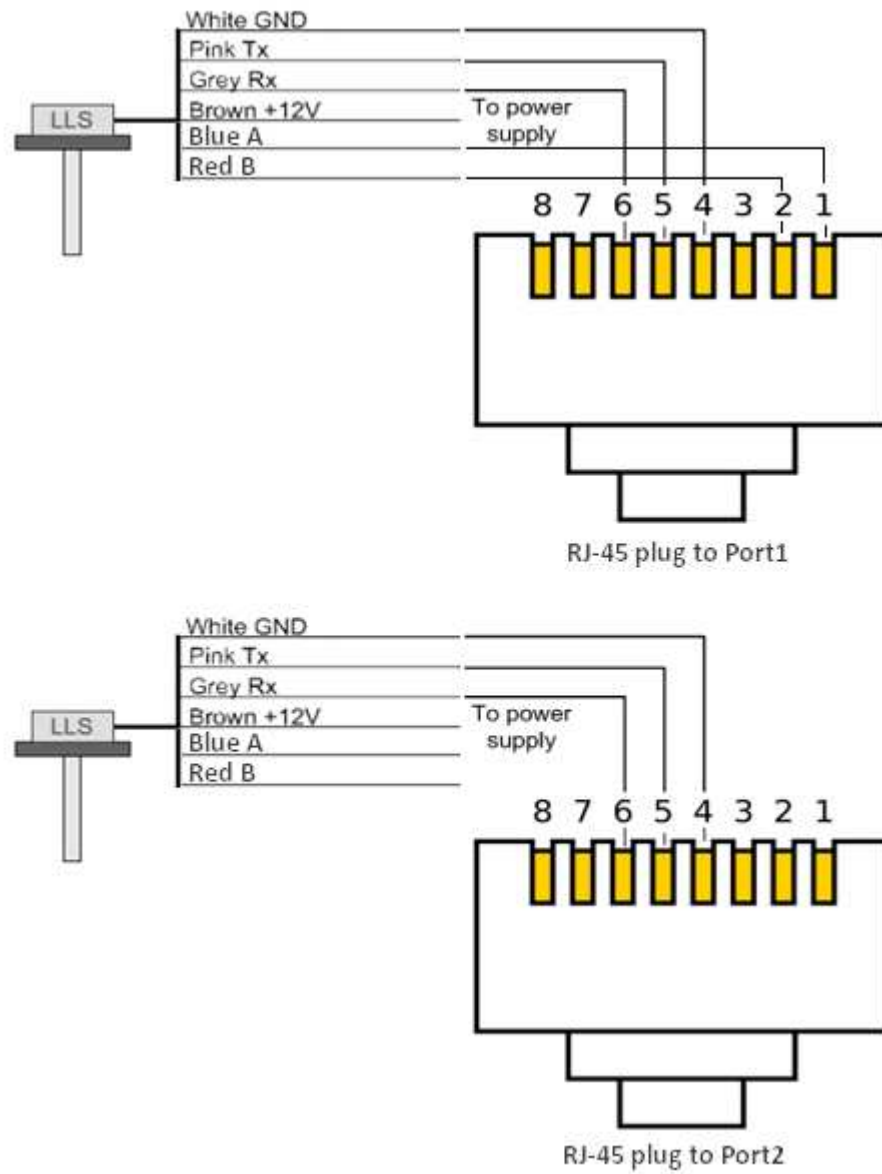

Figure 561 FM5500-LLS two fuel sensor connection via RS232 and RS485 scheme RJ-45 male plug to Port 1 and to Port 2

FM5500-LLS fuel sensor connection via RS485 scheme RJ-45 male plug to Port 1 is shown on Figure 572.

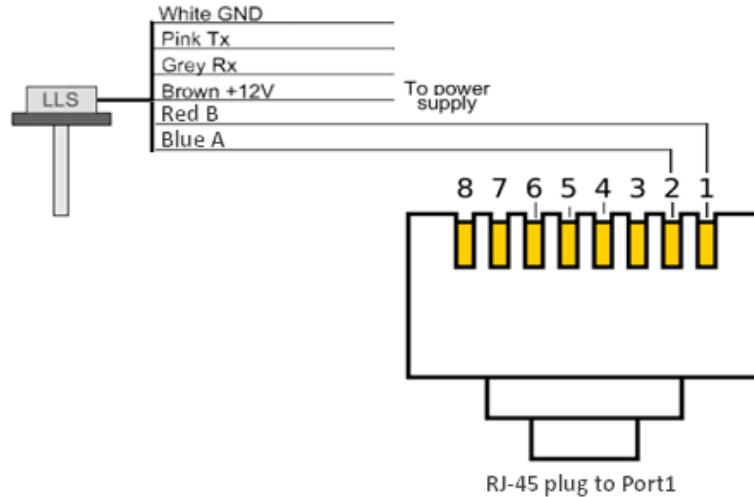

Figure 572 FM5500-LLS fuel sensor connection via RS485 scheme RJ-45 male plug to Port 1

Since LLS has two interfaces (RS-232 and RS-485), then in case utilization of just one interface, wires of the unused interface will not be utilized. It's necessary to insulate them carefully on LLS side (for example with hot shrink tubing), for avoiding any undesirable connections (with power supply positive, with ground, or between themselves).

Then FM5500 must be configured. Both fuel level and fuel temperature has to be set up by configurator's I/O menu (see Figure 5893):

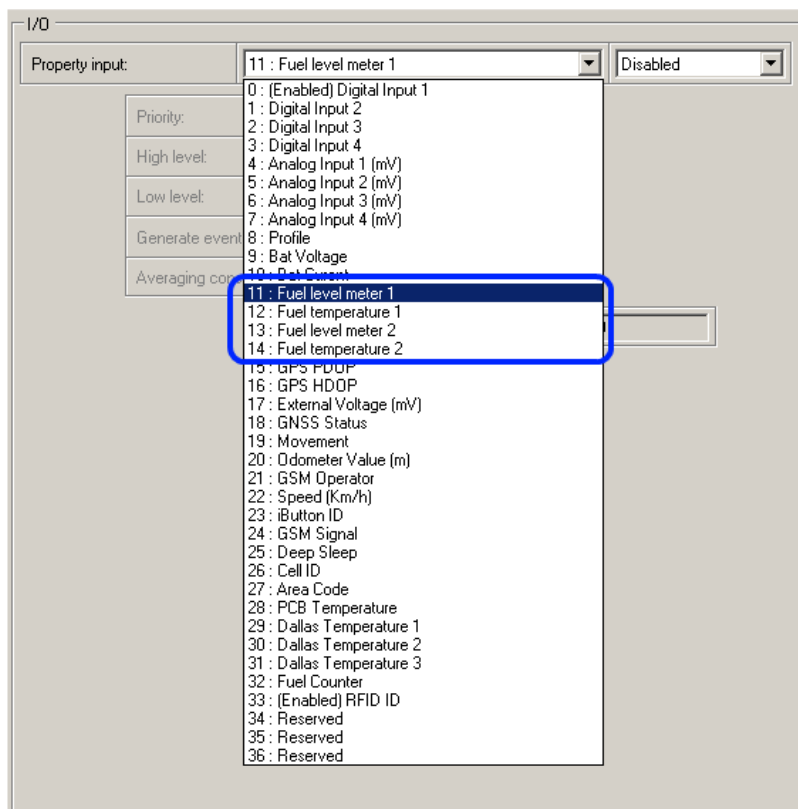

Figure 583 FM5500 I/O Configuration

Enable ID11 and ID12, or ID13 and ID14, or all four I/O elements (Figure 5994) at the same time because two LLS sensors can be connected to FM5500 at the same time (for example if a vehicle has two fuel tanks).

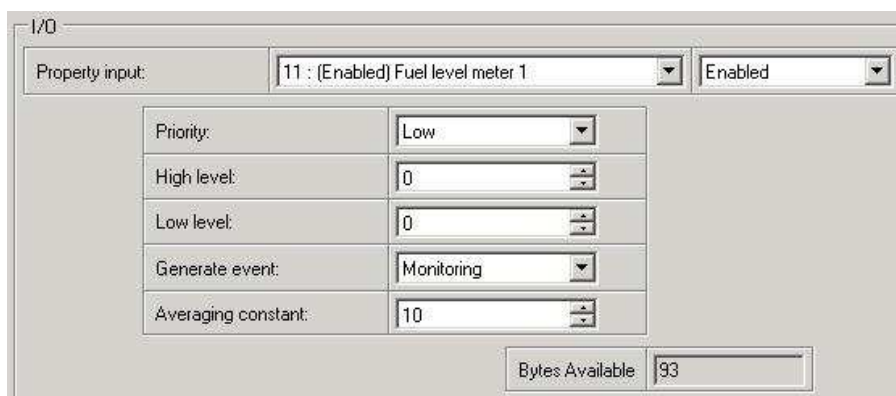

Figure 594 I/O Configuration

When only one LLS sensor is connected FM5500 sends the data in kvants and additional server configuration is required. To get correct data on the server, it has to calculate the values using polynomial calculation. When two LLS sensors are connected the same is applied, but it is possible to enter the polynomials into the configuration of FM5500 and it sends the sum of both LLS sensors, but the data sent is already in liters so no additional calculations have to be made on the server.

No. of LLS sensors	Where polynomials have to be entered
1 (COM1)	On the server (FM5500 sends values from LLS in kvants)
2 (COM1 and COM2)	On the server (FM5500 sends values from LLS in kvants) OR in FM5500 configuration (the device sends the sum of both LLS sensors converted to liters)

Here is an example of how to calibrate LLS sensor and obtain polynomials:

LLS sensor must be put in the intended fuel tank and then configured, using polynomial calculation. The first step is to firmly place the LLS sensor in the fuel tank and calibrate it. The tank should be empty or at least almost empty for the calibration to be successful (or at least as accurate as possible).



IMPORTANT!

Before calibration and calculation of polynomials, make sure that FM5500 polynomial configuration is default. That is all polynomials are 0, except for a1, which is 1. Otherwise, the calculations will be incorrect.

To acquire the correct polynomials a known amount of petrol has to be poured into the fuel tank and the value which is read should be written down. Then another amount should be poured and the next value written down and so on. This should be done till the tank is full. Then the calculation of polynomials has to be made. Here is an example of how to do this, with the values already written down, for example a tank of 150 liters and using an editor program like Microsoft Excel:

The values of the LLS sensor when pouring a known amount of liters into an empty fuel tank are:

Value (kvants, N)	Liters
0	0
90	24
220	42
300	61
400	72
550	84
610	97
690	114
850	138
920	145
1023	150



Note: for more accurate calibration and configuration, the poured liters should not be a high amount (for example three times by 50 liters). Pour a known small amount in order to get the most accurate calculations.

Then, enter these values in Excel and calculate another value N+, according to the formula:

$$N+ = \frac{N}{100} + 1$$

FM5500 converts the read data using this formula, so we need to have the converted values also. Next, enter the new values in Excel and create a scatter chart, like in Figure 6095.

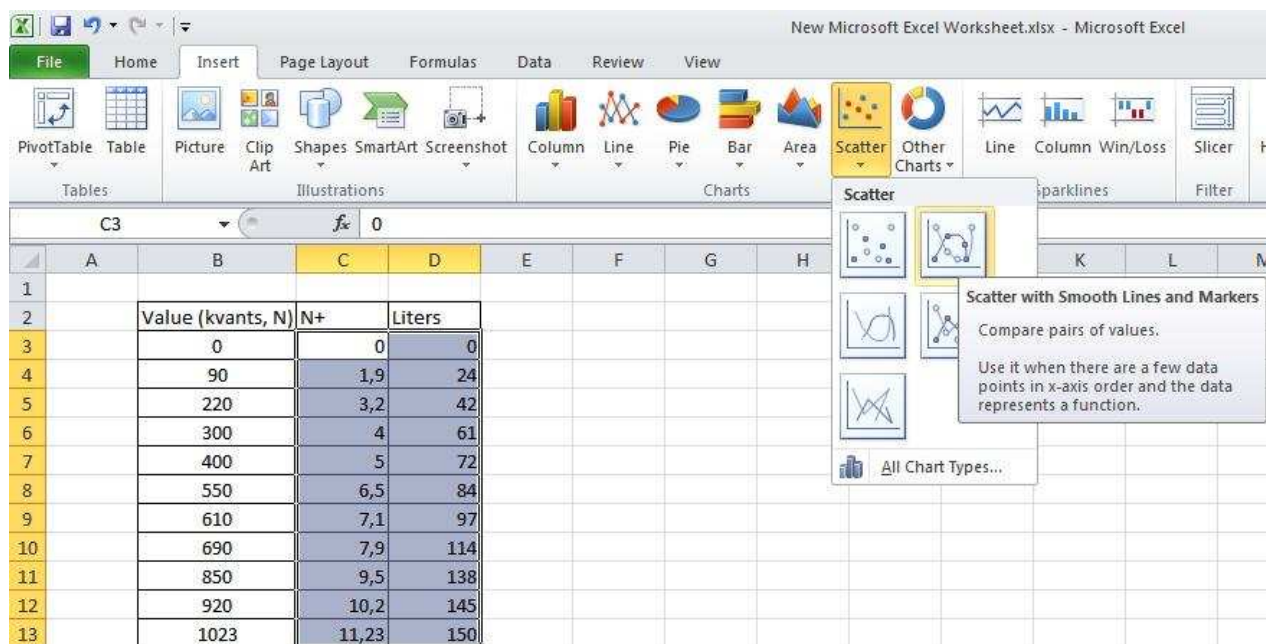

Figure 605 Scatter chart creation

Then right-click on the chart line and select “Add Trendline” (Figure 6196).

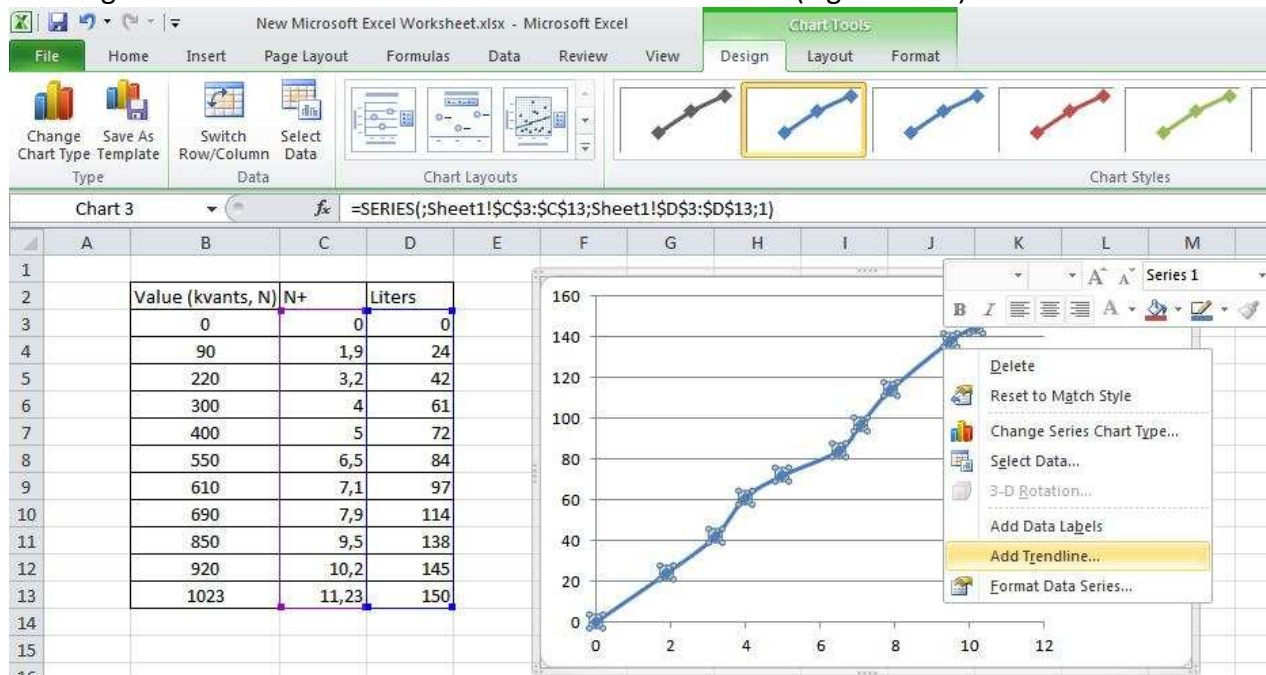

Figure 616 Adding a trendline

Select a polynomial type of 5th order trendline. Also select “Display equation on chart” checkbox (Figure 97).

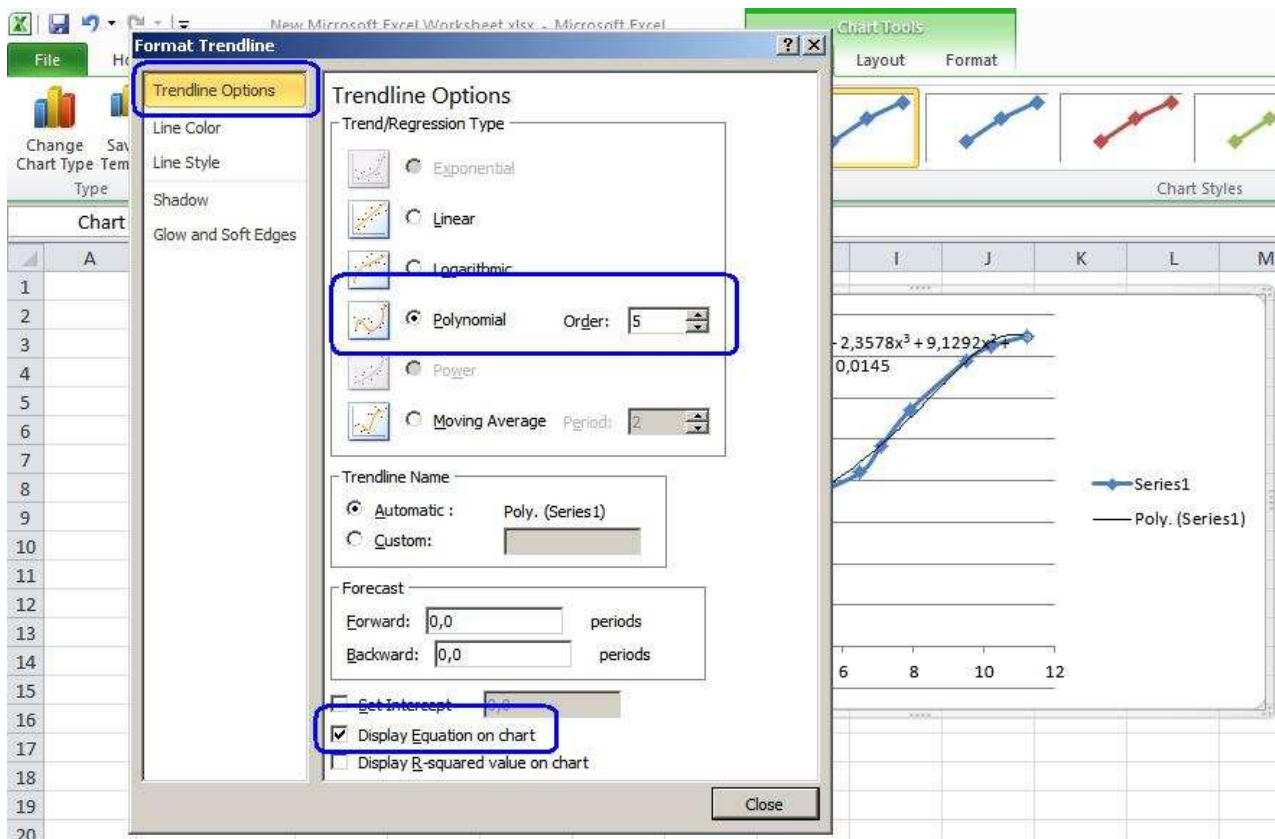

Figure 97 Selecting polynomial order

A new line appears alongside the created one, as well as a formula for that new line (Figure 98).

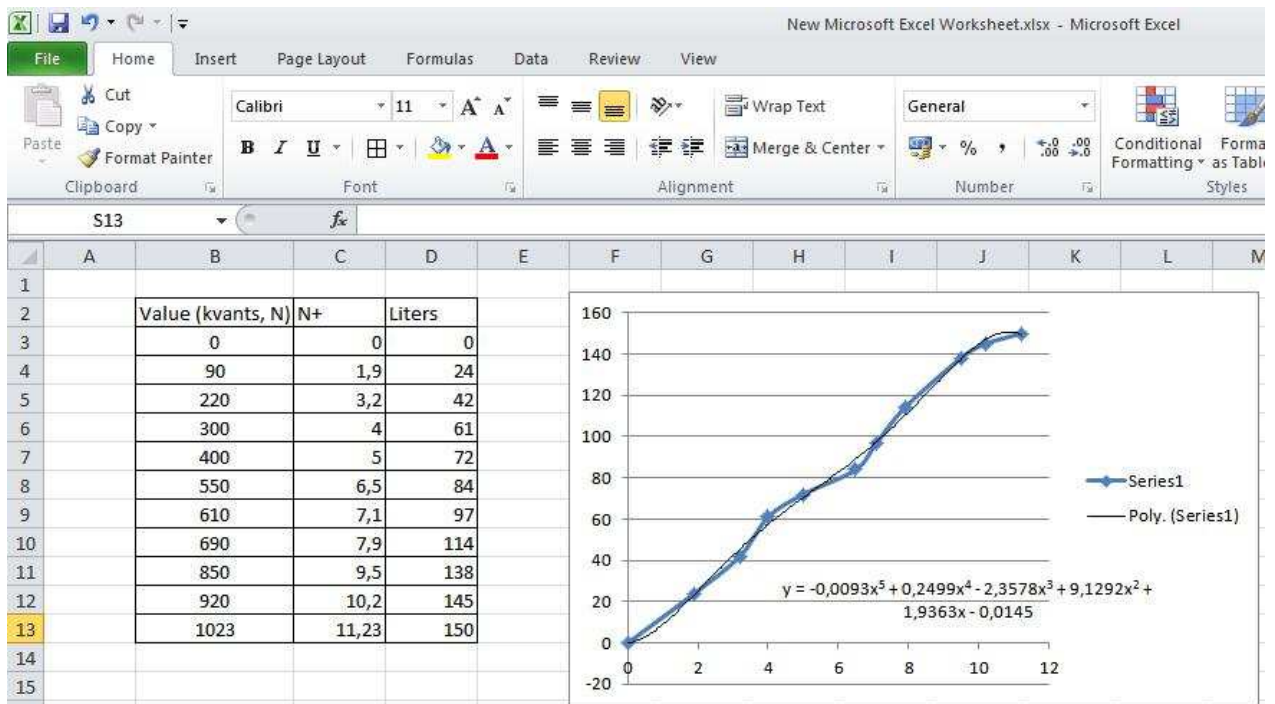

Figure 98 Calculated polynomial line and calculation formula

Final view of the formula should be:

$$y = -0,0093x^5 + 0,2499x^4 - 2,3578x^3 + 9,1292x^2 + 1,9363x - 0,0145$$

Where

$$a_0 = -0,0145$$

$$a_1 = 1,9363$$

$$a_2 = 9,1292$$

$$a_3 = -2,3578$$

$$a_4 = 0,2499$$

$$a_5 = -0,0093$$

Here, the polynomials $a_0...a_5$ have to be written in the polynomial calculation on the server. If it is required for FM5500 to send the data in liters, these polynomials can be written in the configuration of the device. To do this, go to global settings, and choose both ports to work in LLS mode (Figure 99). Also repeat the steps for the second LLS sensor if it is needed.



REMEMBER!

Polynomials can only be written in the configuration when using two LLS sensors at once – if one is used, then the polynomial calculation must be done on the server side.

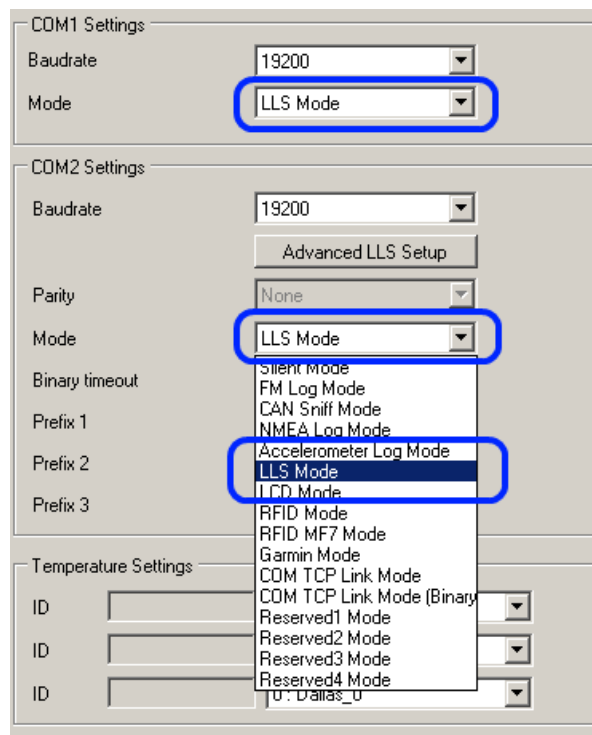

Figure 99 LLS mode settings in Global parameters

Then click “Advanced LLS Setup” in COM2 settings. At the pop upped window (Figure 62100) enter the obtained values of a0...a5 in the appropriate places and click “Write Polynoms”:

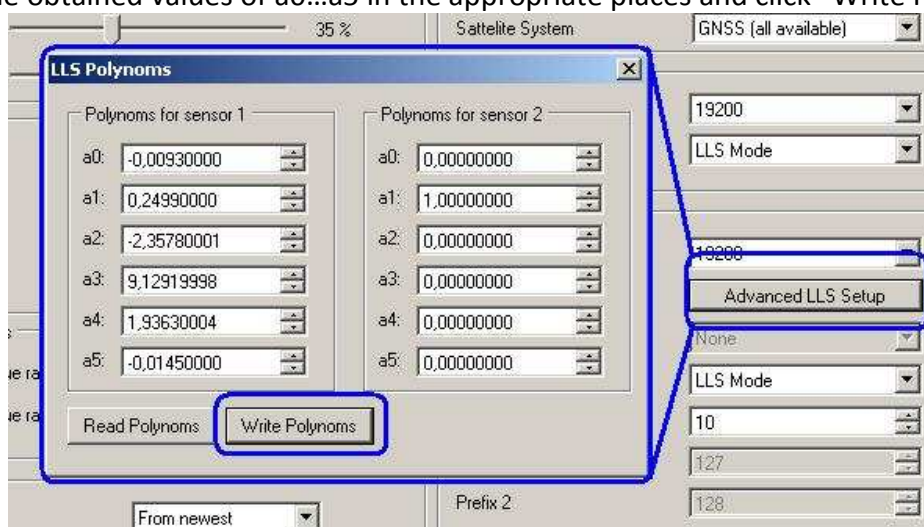

Figure 620 LLS sensor advanced (polynomial) setup

After the configuration is saved successfully FM5500 is ready to send measured fuel level.

For additional information about LLS sensors, their configuration and connectivity to FM5500, please contact us to your local sales representative.

19 GPRS COMMANDS

It is possible to send commands to FM5500 using GPRS. When FM5500 sends records periodically to a server, a message could be sent from the server and FM5500 will reply to it. FM5500 has to be connected to the server in order to receive commands.

Command	Description
#GET DATAORDER	Get info about records sorting parameter
#SET DATAORDERX=Y	Set records sorting parameter, X – profile, Y – value (0/1).
#GET RECTO	Get info about records refresh timeout parameter
#SET RECTO=X	Set records refresh parameter, X = records refresh timeout
#GET VERSION	Receive firmware version
#GET NETWORK	Get GSM operator to which device is connected
#GET IMSI	Get IMSI of the device
#GET OUT	Get DOUT values
#DO REPORT	Save a record
#DO RESET=XXX	Reset FM5500 or GPS module, XXX – FM5X or GPS
#GET ROAMINGX=Y	Get operator from the list of a certain profile, X – profile, Y – operator number in a list
#SET ROAMINGX=Y,Z	Set operator to the list of a certain profile, X – profile, Y – operator number in a list, Z – operator code
#GET REMIPX	Get IP and port number from the configuration of a certain profile, X – profile
#SET REMIPX=Y:Z	Set IP and port number to the configuration of a certain profile, X – profile no, Y – IP or domain, Z – port number
#GET AUPX	Get APN, user login and password from the configuration of a certain profile, X – profile
#SET AUPX=Y,Z,W	Set APN, user login and password to the configuration of a certain profile, X – profile, Y – APN, Z –, user login W - password
#GET REPRTX	Get MinPeriod from the configuration of a certain profile, X – profile
#SET REPRTX=Y	Set MinPeriod to the configuration of a certain profile, X – profile, Y – MinPeriod value
#GET REPDISTX	Get MinDistance from the configuration of a certain profile, X – profile
#SET REPDISTX=Y	Set MinDistance to the configuration of a certain profile, X – profile, Y – MinDistance value
#GET REPANGX	Get MinAngle from the configuration of a certain profile, X – profile
#SET REPANGX=Y	Set MinAngle to the configuration of a certain profile, X – profile, Y – MinAngle value
#GET SENDPERIODX	Get SendPeriod from the configuration of a certain profile, X – profile
#SET SENDPERIODX=Y	Set SendPeriod to the configuration of a certain profile, X – profile, Y – SendPeriod value
#GET REPMRX	Get MinRecords from the configuration of a certain profile, X – profile
#SET REPMRX=Y	Set MinRecords to the configuration of a certain profile, X – profile, Y – MinRecords value
#GET IBTNX	Get iButton value from the configuration of a certain profile, X – profile
#SET IBTNX=Y,Z	Set iButton value to the configuration of a certain profile, X – profile, Y – number on the list, Z – iButton value
#GET EXTERR	Get extended errors value
#SET EXTERR=X	Set extended errors value, X – 0/1

There is also a possibility to send the same messages as in SMS command list (chapter 11). The device sends a response to every command received.

Command	Description
getstatus	Modem Status information
getweektime	Current device time, Day of Week and amount of minutes passed since start of week
getops	List of currently used and available GSM operators
readops#	Emergency gsm operator readout from active profile # - 1,2,3 1 – operators [1-20] 2 – operators [21-40] 3 – operators [41-50]
getnmeainfo	Nmea error debug sms
getcfgtime	Date and Time of last successful configuration
getgps	Current GPS data and time
loadprofile#	Load specified profile into RAM Engine Profile. # - number of profile to load
cpureset	Reset CPU
resetallprof	Reset all FLASH profiles to default profile
getver	Device / Modem / Code version information
getinfo	Device runtime system information
deleterecords	Delete all records saved on FLASH
getio	Readout digital inputs and outputs, analog inputs
radio #	Readout input value according entered ID, # - ID value
setdigout XXXX Y1 Y2 Y3 Y4	Set digital outputs 0 – OFF, 1 – ON Y1 – timeout for DO1 Y2 – timeout for DO2 Y3 – timeout for DO3 Y4 – timeout for DO4
getparam #	Readout parameter value according entered ID. # - ID value.
setparam # #	Set parameter value according entered ID and Value. 1.# - ID value. 2.# - New Parameter Value
flush #,#,#,#,#,#,#	Initiates all data sending to specified target server 1.# - IMEI 2.# - APN 3.# - LOGIN 4.# - PASS 5.# - IP 6.# - PORT 7.# - MODE (0-TCP/1-UDP)
sn x [x=0;1]	Enable/disable static navigation
banlist	Banlist information
crashlog	Crash log information

delete_all_sms	Delete all read SMS
braminfo	BatRam info
getgnss	Current GNSS information
setsimslot	SMS forced SIM switching, 0 – SIM 1, 1 – SIM 2
getsiminfo	SIM 1, SIM 2 info



ATTENTION!

In order to send these commands, they have to be converted to special format. How to convert to this format and for additional information on how to send GPRS commands, please contact to your local sales representative.

20 DEBUG MODE

FM5500 is able to transmit its current state when connected to PC using PORT1/2 cable. It is used to detect errors and provide information to possible solutions when operating as unexpected. Contact our sales manager to get Terminal. After launching it choose baud rate 115200 and hardware control – none. Click on ‘Start Log’ button and save a new file. Then click ‘Connect’ to start receiving messages from FM5500 (see Figure 63101).

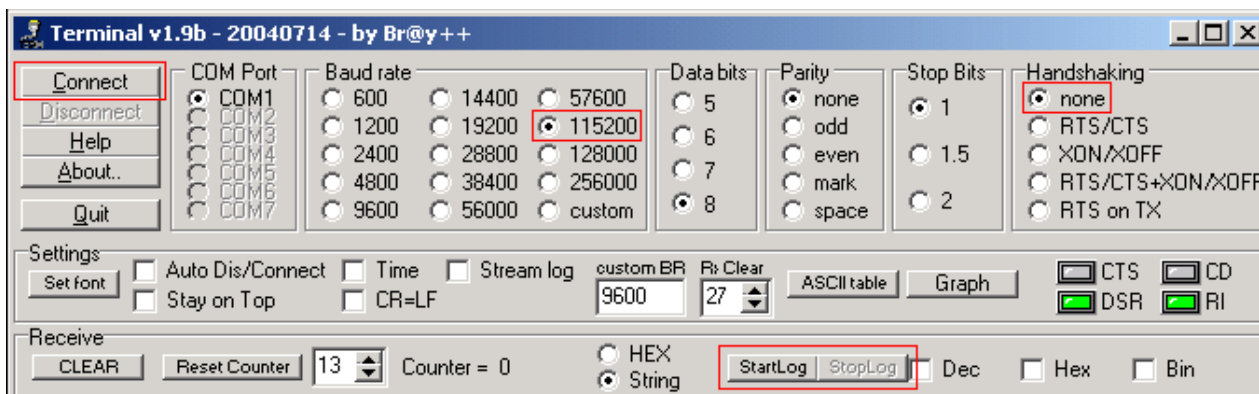

Figure 631 Terminal Window

To debug NMEA GPS data, change baud rate value to 9600 and click connect.

21 CHANGE LOG

Nr.	Date	Version	Comments
1	2012-12-21	1.0	Preliminary release draft
2	2012-12-27	1.1	Correction according to Support notes
3	2012-12-31	1.2	Correction according to Support notes
4	2013-01-03	1.3	Correction according to Support notes
5	2013-01-08	1.4	Correction according to Support notes
6	2013-01-14	1.5	Final version