

WAPB1E20A

WiFi AP

- 2 × WiFi (802.11a/b/g/n/ac)
- 2.4 GHz / 5 GHz, 2 × 2 MIMO
- 2 × Ethernet 1 Gbps M12
- 2 × USB 2.0
- Power supply 24 V DC / 36 V DC with GI
- Designed in accordance with EN 50155 ed. 3

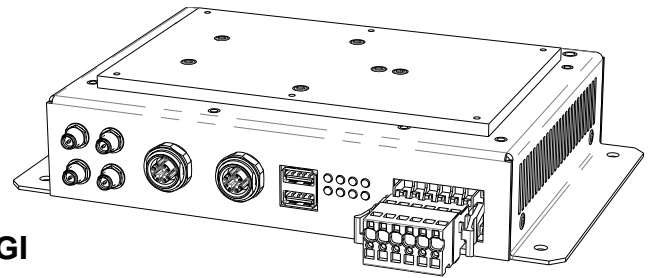

TECHNICAL PARAMETERS

CPU	Intel Atom E3815 1.46 GHz, 2 GB DDR3L, 4 GB eMMC FLASH
WiFi	2 ×
Communication standards	802.11a/b/g/n/ac 2.4 GHz + 5 GHz
Connection point	2 × R-SMA
Ethernet	2 ×
Data transmission rate	10 Mbps / 100 Mbps / 1 Gbps
Connection point	8-pin connector M12, X-coded
USB	2 × USB 2.0
Connection point	2 × connector type A, host
IO	2 × digital input/output, 24 V DC
Power supply	24 V DC / 36 V DC with GI
Power consumption	0.5 A at 24 V DC
Connection point	WAGO 769-106/021-000
Others	
Mechanical construction	Sheet metal cover
Mounting	On the base plate
Cover protection rate	IP30
Operating temperature range	-40 °C to 70 °C
Storage temperature range	-40 °C to 70 °C
Max. ambient humidity	< 95 % non-condensing
Weight	1.52 kg
Dimensions (w × h × d)	(230 × 46 × 175) mm

ORDERING INFORMATION

WAPB1E20A	WiFi AP, certificate of product quality and completeness, routine test protocol, insulation test protocol
------------------	---

CONNECTOR LOCATION

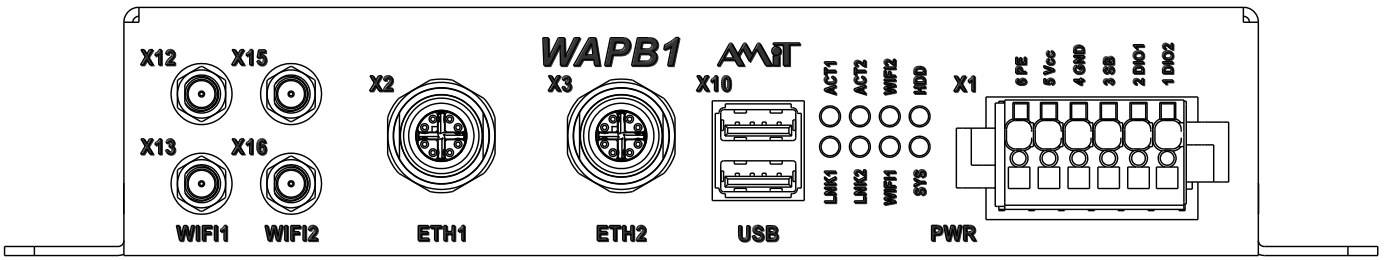

DIMENSIONS

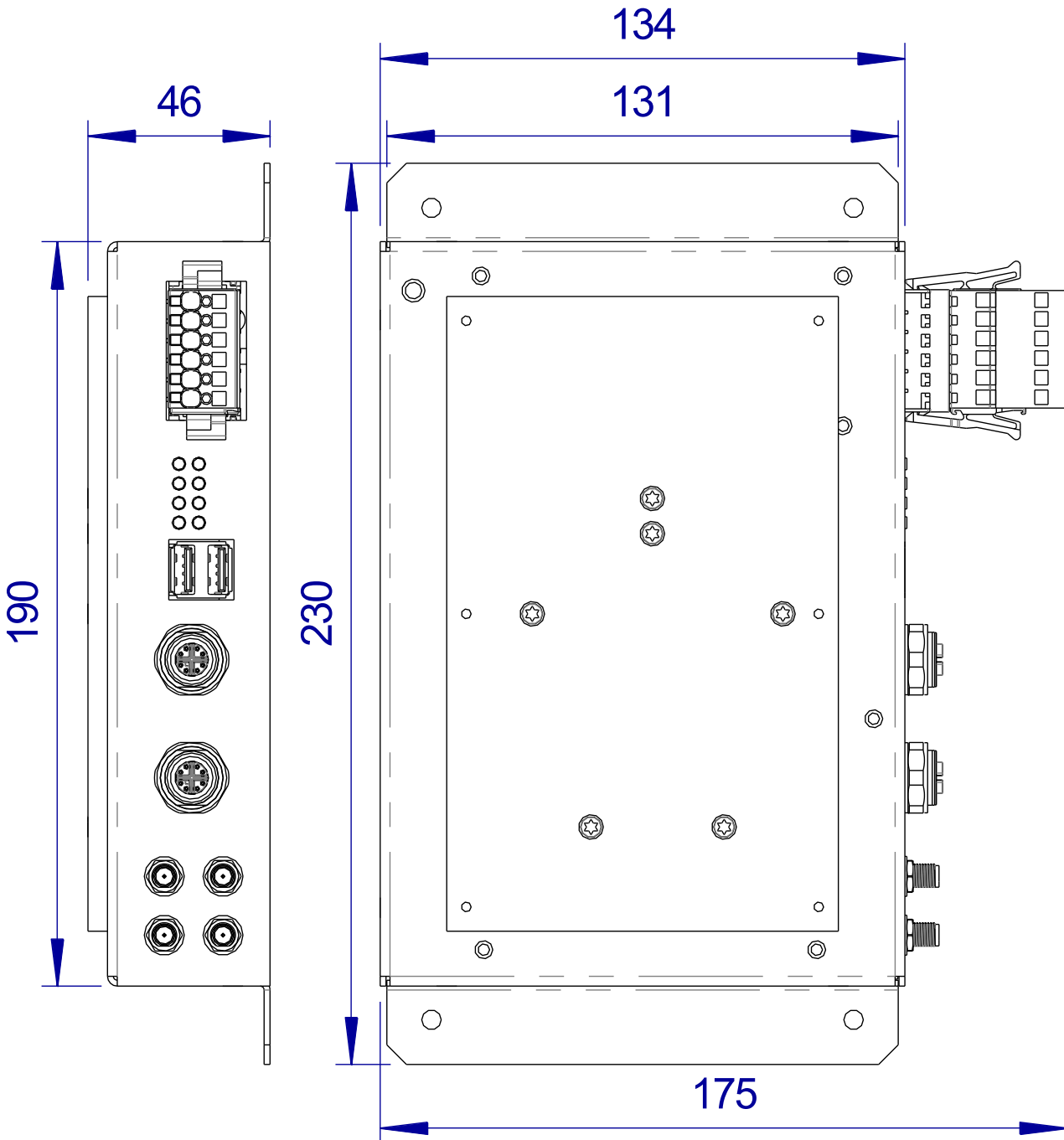

WAPB1E20A

WiFi AP

RECOMMENDED DRAWING SYMBOL

